

ARCOS®

Albacete (Spain) Since 1734



**CATÁLOGO
2025**

CATALOGUE
2025

Autor del documento:
Arcos Hermanos S.A.

Datos de contacto:
E-Mail: comercial@arcos.com
Página Web: www.arcos.com
Teléfono: +34 967 210 261

Fecha: 01-01-2025
Diseño: Arcos Hermanos S.A.
Fotografía: Arcos, Neón Fotografía, Casanova
Impresión: Gráficas Cano

Licencia del documento:
Copyright © 2025, Arcos Hermanos S.A.

Los logos y marcas anunciados o referidos en este documento son propiedad de sus respectivos dueños.



Papel procedente de fuentes responsables.
Para más información www.fsc.org

- 5** **ARCOS, CASI 300 AÑOS**
ARCOS, ALMOST 300 YEARS // ARCOS, PRESQUE 300 ANS // ARCOS, QUASI 300 ANNI // ARCOS, QUASE 300 ANOS
- 21** **NOVEDADES**
NOVELTIES // NOUVEAUTÉS // NOVITÀ // NOVIDADES
- 31** **CUCHILLOS**
KNIVES // COUTEAUX // COLTELLERIA // FACAS
- 151** **NAVAJAS**
PROFESSIONAL POCKET KNIVES // COUTEAUX DE POCHE PROFESSIONNELS // COLTELLO DA TASCA // FACAS POFISSIONAIS
- 153** **CHULETEROS**
STEAK KNIVES // COUTEAUX À STEAK // COLTELLERIA // FACA DE CHURRASCO
- 177** **CUCHILLOS MESA**
TABLE KNIVES // COUTEAUX DE TABLE // COLTELLERIA DA TAVOLA // FACA DE MESA
- 187** **CUBERTERÍAS**
FLATWARE // COUVERTS // POSATERIA // TALHERES
- 227** **TIJERAS**
SCISSORS // CISEAUX // FORBICI // TESOURAS
- 245** **SARTENES Y CACEROLAS**
COOKWARE // POÊLES ET CASSEROLES // PADELLE E CASSERUOLE // FRIGIDEIRAS E PANELAS
- 269** **ÚTILES**
PROFESSIONAL TOOLS // OUTILS PROFESSIONNELS // UTENSILI PROFESSIONALI // UTENSÍLIOS
- 263** **GADGETS**
- 283** **UTENSILIOS**
UTENSILS // USTENSILES // UTENSILI // UTENSÍLIOS
- 287** **COMPLEMENTOS**
ACCESSORIES // COMPLÉMENTS // COMPLEMENTI // COMPLEMENTOS
- 327** **SOBRE ARCOS**
ABOUT ARCOS // À PROPOS DE ARCOS // SU ARCOS // SOBRE ARCOS

ARCOS®

Albacete (Spain) Since 1734



Francisco de Arcos
Ana Lujana

Miguel de Arcos
María Gallardo

Primer cuchillero

1708

JUAN DE ARCOS GALLARDO
María de la Cuesta

ARCOS

1734

Tijeras de escritorio realizadas por Juan de Arcos Gallardo. Marcan el inicio de la trayectoria de ARCOS

There are desk scissors, made by Juan de Arcos Gallardo dating the beginning of ARCOS.

1742

JUAN DE ARCOS DE LA CUESTA
Ana Pastor

1778

JUSTO ARCOS PASTOR
Francisca Aparicio

1814

ISIDRO ARCOS APARICIO
Ana Aroca



1851

LEONARDO GREGORIO ARCOS AROCA
María Jesús Abia

**G. ARCOS
ALBACETE**

1878

ROBERTO ARCOS ABIA
Inocencia Villanueva

**R. ARCOS
ALBACETE**

1925

GREGORIO ARCOS VILLANUEVA
Luisa Gallano Blasco



1970

ROBERTO ARCOS GALIANO
Pedro Arcos Galiano
Ana Arcos Galiano

ARCOS
ARCOS
ARCOS

2022

ROBERTO ARCOS PÉREZ
Sara Arcos Pérez
Luis Arcos Ríos
Marta Arcos Ríos

ARCOS
Albacete (Spain) Since 1734

UN TALLER, CASI 300 AÑOS DE PASIÓN CULINARIA



En el rincón más acogedor de Albacete, hace casi 300 años, un pequeño taller cobró vida, nació la esencia de Arcos. Juan de Arcos, con su maestría, daba vida a las primeras tijeras bajo el sello distintivo de nuestra marca. Estas tijeras, más que simples herramientas, encierran la pasión, artesanía y evolución que nos ha caracterizado desde entonces. Desde aquel primer corte, Arcos ha sido más que un lugar de trabajo: un hogar donde cada cuchillo es creado con el mismo cariño y la dedicación que se encuentra en el alma de cada cocina.

Agradecemos sinceramente a todos aquellos que han compartido este viaje con nosotros, confiando en la excelencia de nuestros productos. Con la mirada puesta en el futuro, nos llena de emoción seguir siendo su elección de confianza, llevando consigo la rica tradición y la constante innovación que nos identifica. Que cada corte con un cuchillo Arcos represente un capítulo único en su viaje culinario, y esperamos seguir siendo cómplices de estas experiencias en los próximos años.

ONE WORKSHOP, ALMOST 300 YEARS OF CULINARY PASSION.

In the cosiest corner of Albacete, nearly 300 years ago, a small workshop came into being; the essence of Arcos was born. Juan de Arcos, with his expertise, made the first pair of scissors under the distinctive sign of our brand. These scissors, more than simple tools, embodied the passion, craftsmanship and the evolution that has defined us ever since. Since that first cut, Arcos has become more than just a workplace: a home where each knife is created with the tender loving care and the dedication that is found in the soul of each kitchen.

We sincerely appreciate everyone who has shared this journey with us, trusting in the excellence of our products. Looking ahead to the future, we are thrilled to still be your trusted choice, which comes with the rich tradition and the constant innovation that identifies us. Each cut with an Arcos knife stands for a unique chapter in its culinary journey, and we hope to continue sharing these experiences with you all in the next few years.



UN ATELIER, PRESQUE 300 ANS DE PASSION CULINAIRE.

Dans le quartier le plus joli d'Albacete, il y a près de 300 ans, un petit atelier a vu le jour : l'essence d'Arcos était née ! Juan de Arcos, avec sa maîtrise, donna vie aux premiers ciseaux sous notre marque distinctive. Ces ciseaux, qui étaient bien plus que de simples outils, résument la passion, l'artisanat et l'évolution qui nous ont toujours caractérisés. Depuis cette première découpe, Arcos est bien plus qu'un simple espace de travail : c'est un foyer où chaque couteau est créé avec autant d'amour et de dévouement qu'il y a dans l'âme de chaque cuisine.

Nous tenons à remercier chaleureusement tous ceux qui ont partagé ce voyage avec nous, confiants dans l'excellence de nos produits. Alors que nous nous tournons vers l'avenir, nous sommes ravis de continuer à être votre premier choix, portant ainsi la riche tradition et l'innovation constante qui nous identifient. Que chaque découpe avec un couteau Arcos représente un chapitre unique de votre voyage culinaire, et nous souhaitons continuer à être complices de ces expériences pour les années à venir.



Fabrica de Arcos en los años 80' // Arcos Factory in the 80's

UN LABORATORIO, QUASI 300 ANNI DI PASSIONE CULINARIA.

Quasi 300 anni fa nell'angolo più accogliente di Albacete, prese vita un laboratorio nel quale nacque l'essenza di Arcos. Juan de Arcos, con la sua abilità, diede vita alle prime forbici che portavano il sigillo distintivo del nostro marchio. Queste forbici sono più che semplici strumenti: racchiudono la passione, l'artigianalità e l'evoluzione che ci hanno caratterizzato sin da allora. Da quel primo taglio, Arcos è diventato molto più che un semplice luogo di lavoro: si è trasformato in una casa, nella quale ogni coltello viene creato impiegando lo stesso affetto e la stessa dedizione che risiedono nell'anima di ogni cucina.

Ringraziamo sinceramente tutti coloro che hanno condiviso questo viaggio con noi, riponendo la loro fiducia nell'eccellenza dei nostri prodotti. Guardando al futuro, ci emoziona profondamente continuare ad essere la vostra scelta di fiducia, la quale racchiude la ricca tradizione e la costante innovazione che ci caratterizza. Ci auguriamo che ogni taglio di un coltello Arcos rappresenti un capitolo unico del vostro viaggio culinario e speriamo di poter rimanere i complici perfetti di queste esperienze negli anni a venire.

UMA OFICINA, QUASE 300 ANOS DE PAIXÃO CULINÁRIA.

No recanto mais acolhedor de Albacete, há quase 300 anos, uma pequena oficina ganhou vida, nascia a essência de Arcos. Juan de Arcos, com a sua mestria, deu vida às primeiras tesouras com o selo distintivo da nossa marca. Estas tesouras, mais do que simples ferramentas, encerram em si a paixão, o artesanato e a evolução que nos caracteriza desde então. Desde esse primeiro corte, a Arcos tem sido mais do que um local de trabalho: uma casa onde cada faca é criada com o mesmo amor e dedicação que está na alma de cada cozinha.

Agradecemos sinceramente a todos aqueles que partilharam conosco este percurso, confiando na excelência dos nossos produtos. A olhar para o futuro, estamos entusiasmados por continuar a ser a sua escolha de confiança, levando conosco a rica tradição e a constante inovação que nos identifica. Que cada corte com uma faca Arcos represente um capítulo único na sua viagem culinária, e nós esperamos continuar a ser cúmplices dessas experiências nos próximos anos.

ICONOGRAFÍA



NEW

Nuevo // New // Nouveau // Nouvo // Novo



Sierra // Serrated // Cranté // Seghettato // Perolado



Microdentado // Micro-Serrated // Microdenté
Microdentato // Micro-Serrilhada



Madera Comprimida // Pack Wood // Bois Compressé
Legno Compresso // Madeira comprimida



Antideslizante // Non-slip // Antidérapant // Antiscivolo
Antiderrapante



Resistente a altas temperaturas // High-Temperature
Resistant // Résistant Aux Hautes températures
Resistente Alle Alte Temperature // Resistente a Altas
Temperaturas.



Remaches // Stainless Steel Rivets // Rivets en
Acier Inoxydable // Rivetti in Acciaio Inossidabile
Rebites de Aço Inoxidável.



Remaches Anticorrosión // Anti-Corrosion Rivets
Rivets Anticorrosion // Rivetti in Rivetti Anticorrosione
Rebites Anticorrosão.



Medida de la hoja // Blade Measurement // Mesure de la
Lame // Misura della Lama // Medida da Lâmina.

Medida Completa // Full Measurement // Mesure
Complète // Misura Completa // Medida Completa.



Presentación // Presentation // Présentation
Presentazione // Apresentação



Materiales // Materials // Matériaux // Materiali
Materiais



Cuchillos Estilo Japonés // Japanese Style Knives
Couteaux Style Japonais // Coltelli Stile Giappones
Facas Japonesas



Canal para líquidos // Liquid channel // Avec Rigole
Scanalatura per Liquidi // Canal para Líquidos



Hueco salsaera // Gravy Boat Hole // Emplacement Sauce
Foro salsaera // Cavidade para Molho



Antideslizante // Non-Slip // Antidérapant // Antiscivolo
Antiderrapante

**FORJADO • FORGED • FORGÉ • FORGIATO • FORJADO**

Sometido al proceso de forja al rojo vivo que tiene como resultado un cuchillo macizo de una sola pieza a través de un moldeado perfecto.
Submitted to red-hot forging process which results in a solid single-piece knife through a flawless moulding.
Soumis au processus de forgeage à chaud ayant pour résultat un couteau massif d'une seule pièce grâce à un moulage parfait.
Sottoposto al processo di forgiatura al rosso vivo, il cui risultato è un coltello massiccio, in un solo pezzo, mediante uno stampaggio perfetto.
O processo de forjamento a quente resulta numa faca sólida e de uma só peça através de uma moldagem perfeita.

**FILLO SEDA • SILK EDGE • SILK EDGE • FILO SETA • FIO SEDA**

El filo especial seda ha sido creado uniendo nuestra tradición y la tecnología más innovadora, obteniendo así un corte único caracterizado por su suavidad y precisión.
The special silk edge has been created by combining our tradition and cutting-edge technology, thereby obtaining a unique cut characterised by its smoothness and precision.
Le tranchant "silkyedge" a été créé en conjuguant savoir-faire traditionnel et technologie novatrice pour obtenir une coupe unique précise et facile.
Lo speciale filo seta è stato creato unendo alla nostra tradizione la tecnologia più innovatrice, per ottenere un taglio unico, caratterizzato dalla sua morbidezza e precisione.
O fio especial seda foi criado combinando a nossa tradição e a tecnologia mais inovadora, obtendo assim um corte único caracterizado pela sua suavidade e precisão.

**FILLO SEDA PLUS • SILK EDGE PLUS • SILK EDGE PLUS • FILO SETA • FIO SEDA**

Sensación de corte extra suave. Proceso manual realizado por maestros cuchilleros.
Extra smooth cutting sensation. Manual process carried out by master knife makers.
Sensation de coupe extra fluide. Processus manuel réalisé par des maîtres couteliers.
Sensazione di taglio extra morbida. Processo manuale realizzato da maestri coltellinai.
Sensation de coupe extra douce. Processus manuel réalisé par des maîtres couteliers.

**RECAZO REDONDEADO • ROUNDED BACK • DOS DE LAME ADOUCI • COSTOLA ARROTONDATA • DORSO ARREDONDADO**

Borde superior de la hoja que proporciona una suavidad en el uso, evitando roces en la mano.
Upper edge of the blade which provides a smoothness when used avoiding hand chafing and abrasions.
Dos des lames arrondis pour plus de confort et de douceur lors de la manipulation.
Il bordo superiore della lama fornisce morbidezza d'uso ed evita attriti sulla mano.
O dorso da lâmina proporciona uma suavidade na utilização, evitando o atrito na mão.

**NITRUM®**

Fórmula exclusiva de acero al nitrógeno que proporciona más dureza, mayor poder de corte y mejora la durabilidad del filo.
Its exclusive nitrogen treated steel composition provides additional hardness, greater cutting power and improved cutting edge durability.
Formule exclusive en acier à l'azote pour davantage de dureté, un plus haut pouvoir de coupe et un tranchant plus résistant.
Formula esclusiva di acciaio al nitrogeno che conferisce maggiore durezza, più potere di taglio, e aumenta la durata del filo.
Fórmula exclusiva de aço com nitrogénio que proporciona maior dureza, maior poder de corte e melhora a durabilidad do fio.

**INYECCIÓN • INJECTION • INJECTION • INIEZIONE • INJEÇÃO**

El mango se solidifica alrededor de la espiga del cuchillo consiguiendo un conjunto de hoja-cuchillo sólido, robusto e inseparable.
The handle is solidified around the tang of the knife obtaining an integrated, solid and sturdy knife-blade set.
Le manche est solidement intégré à la soie du couteau, créant ainsi un ensemble lame-couteau solide, robuste et indissociable.
Il manico si solidifica attorno al codolo del coltello, ottenendo un'unione tra lama e coltello solida, robusta e inseparabile.
O cabo é solidificado em torno do ricasso da faca para um conjunto lâmina faca sólido, robusto e inseparável.

**DOBLE INYECCIÓN • DOUBLE INJECTION • DOUBLE INJECTION • DOPPIA INIEZIONE • INJEÇÃO DUPLA**

Mango compuesto por dos materiales diferentes que otorga al cuchillo resistencia y comodidad para el uso prolongado.
A handle composed of two different materials which endows the knife with resistance and comfort for prolonged use.
Manche composé de deux matériaux différents pour obtenir un couteau résistant et confortable pour un usage prolongé.
Manico composto da due materiali diversi che conferiscono resistenza al coltello e garantiscono il comfort in caso di uso prolungato.
O cabo é feito de dois materiais diferentes que dão à faca resistência e conforto para uma utilização prolongada.

**MANGO ACRÍLICO (PMMA) • ACRYLIC (PMMA) • ACRYLIC (PMMA) • ACRYLIC (PMMA)**

Patrones únicos e irrepitibles, elemento distintivo que aporta un carácter especial al cuchillo.
Unique and unrepeatable patterns, a distinctive feature that adds special character to the knife.
Des motifs uniques et inimitables, un élément distinctif qui confère un caractère unique au couteau.
Motivi unici e irripetibili, un elemento distintivo che dona un carattere speciale al coltello.
Padrões únicos e irrepitíveis, um elemento distintivo que confere um caráter especial à faca.



NSF (National Sanitary Foundation)

Avalado por la prestigiosa certificación norteamericana NSF (National Sanitary Foundation) Sobre la salud alimentaria.
Endorsed by the prestigious North American NSF (National Sanitary Foundation) certification on food safety.
Ayant reçu la prestigieuse certification américaine NSF (National Sanitary Foundation) relative à la santé alimentaire.
Garantito dalla prestigiosa certificazione americana NSF (National Sanitary Foundation) sulla salute alimentare.
Avalizada pela prestigiada certificação norte-americana NSF (National Sanitary Foundation) para a segurança alimentar.



ICE PLUS®

Tratamiento térmico a -80°C aplicado al acero inoxidable que le proporciona especial resistencia al desgaste.
-80°C Heat Treatment applied to the stainless steel offering special resistance against wear and tear.
Traitement thermique à -80°C appliqué sur l'acier inoxydable pour une résistance supérieure à l'usure.
Trattamento termico a -80°C applicato all'acciaio inox che conferisce una particolare resistenza all'usura.
Tratamento térmico a -80°C aplicado ao aço inoxidável, o que lhe confere uma resistência especial ao desgaste.



BACTIPROOF SILVER®

Sistema anti-bacteriano aplicado al mango que reduce en un 99,9% la presencia de bacterias, hongos o moho.
An anti-bacterial system combination applied to the handle which reduces by 99.9% the presence of bacteria, fungi or mould.
Système anti-bactéries appliqué au manche, assurant une réduction de la présence de bactéries, de champignons et de moisissure de 99,9 %.
Sistema anti-batterico applicato al manico che riduce del 99,9% la presenza di batteri, funghi o ruggine.
Um sistema antibacteriano aplicado no cabo que reduz a presença de bactérias, fungos ou bolores em 99,9%.



PLASTICOS TÉCNICOS • TECHNICAL PLASTICS • PLASTIQUES TECHNIQUES • PLASTICHE TECNICHE • PLÁSTICOS TÉCNICOS

Plásticos técnicos de uso alimentario que otorgan al mango del cuchillo alta resistencia química, mecánica y alta durabilidad.
Technical plastics for food use, which provide the knife handle high chemical and mechanical resistance and great durability.
Plastiques techniques à usage alimentaire dotant le manche du couteau d'une haute résistance chimique, mécanique et d'une grande durabilité.
Plastiche tecniche ad uso alimentare, che dotano il manico del coltello di un'alta resistenza chimica, meccanica e un'alta durezza.
Plásticos técnicos de uso alimentar que conferem ao cabo da faca uma elevada resistência química, mecânica e uma grande durabilidade.



MANGO DE MICARTA • MICARTA HANDLE • MANCHE EN MICARTA • MANICO DI MICARTA • PUNHO MICARTA

Tela prensada con resina. Material duro y resistente a temperaturas elevadas y humedad ambiental.
Resin pressed composition. Rigid material and resistant to high temperatures and ambient humidity.
Tissus compressés avec de la résine. Matériau dur et résistant aux hautes températures et à l'humidité ambiante.
Tela pressata con resina. Materiale duro e resistente alle temperature elevate e all'umidità ambientale.
Tecido prensado com resinas, material duro e resistente a altas temperaturas e humidade.



MANGO DE MADERA • WOOD HANDLE • MANCHE EN BOIS • MANICO DI LEGNO • PUNHO DE MADEIRA

Madera 100% natural / Moldeada
100% natural wood / Carved
Bois 100 % naturel / Moulé
Legno 100% naturale / Modellato
Madeira 100% natural / Moldada

PROCESOS Y MATERIALES

MATERIALS AND PROCESSE • PROCESSUS ET MATÉRIAUX
PROCEDIMENTI E MATERIALI • PROCESSOS E MATERIAIS



10 YEAR GUARANTEE



ECLIPSE



BROOKLYN



MANHATTAN



ÓPERA



NÓRDIKA

RIVIERA



RIVIERA BLANC



CLARA



MAITRE

NIZA

LÍNEA

LATINA













NOVA

UNIVERSAL PRO

COLOUR PRO

2900

DÚO PRO

			NITRUM®	 Micarta	 Natural Natural Naturale Natural	 Moldeada Carved Modellée Modellato Moldada	 Inyección Injection Iniezione Injeção	 Doble Inyección Double Injection Doppia Iniezione Injeção Dupla	 Mango Acrílico Acrylic Handle Manche en acrylique Cabo Acrílico	 Polioximetileno (POM) Polyoxymethylene (POM) Polioxyméthylène (POM) Polioxymethylene (POM)	 Polipropileno Polypropylene Polypropylène Polipropilene	REMACHES RIVETS RIVETTI REBITES				
	●	●	●						●			●				
●		●	●	●								●				
●		●	●							●		●				●
●		●	●							●		●	●			
●		●	●		●							●				
			●							●		●				●
			●							●		●				●
			●				●					●				
			●				●					●	●			
			●				●					●	●			
			●			●						●	●			
			●					●				●	●			
			●							●		●	●			
			●									●	●	●		
			●				●					●	●			
			●					●				●	●	●		
			●									●	●	●		

PROCESOS DE FABRICACIÓN

EL TEMPLE

THE TEMPER · LA TREMPE · LA TEMPRA · A TÊMPERA

El temple es la fase más importante en el proceso de fabricación de una herramienta de corte. Consiste en un tratamiento térmico del acero a una temperatura alta (aprox. 1070°C), manteniéndola durante un tiempo determinado (tiempo de austenización) y, a continuación, realizando un rápido enfriamiento a temperatura ambiente, obteniendo de este modo la transformación de la estructura molecular del acero (reacción martensítica), que se manifiesta con un aumento de la dureza del acero. La dureza es la cualidad física necesaria para obtener un buen poder y durabilidad del corte del cuchillo. Además, la correcta estructura interna del acero otorga una mayor resistencia a la corrosión. ARCOS realiza el tratamiento térmico de temple en hornos continuos de atmósfera controlada y, posteriormente, realiza un segundo tratamiento térmico –llamado revenido- que consiste en un calentamiento a 250°C, para eliminar cualquier tensión creada por el rápido enfriamiento del temple que pudiese producir fragilidad en el acero, garantizando las mismas propiedades mecánicas a lo largo de todo el filo de la herramienta.

The temper is the most important phase in the manufacturing process of a cutting tool. It consists of a thermal treatment of steel to a high temperature (around 1070°C), keeping it during a certain time (time of austenization) and then, carrying out a quick cooling up to room temperature, obtaining this way the transformation of the molecular structure of the steel (martensitic reaction), which becomes evident with an increase of the hardness of the steel. Hardness is the physical necessary quality to obtain a good power and cut durability from a knife. In addition, the right internal structure of the steel grants a major resistance to corrosion. ARCOS carries out the thermal treatment of temper in constant furnaces with controlled atmosphere and, later, carries out a second thermal treatment – so called tempering - that consists of a warming to 250°C, in order to eliminate any tension made by the rapid cooling of the temper that could produce fragility in the steel, granting the same mechanical properties along the whole edge of the tool.

La trempe est l'étape la plus importante dans le processus de fabrication d'un outil de coupe. Elle consiste en un traitement thermique de l'acier à haute température (environ 1070 °C), maintenue pendant une durée précise (temps d'austénitisation), suivi d'un refroidissement rapide à température ambiante. Ce procédé transforme la structure moléculaire de l'acier (réaction martensitique), ce qui se traduit par une augmentation significative de sa dureté.

La dureté est une qualité essentielle pour garantir une excellente capacité de coupe et une durabilité accrue du couteau. De plus, une structure interne correcte de l'acier améliore sa résistance à la corrosion.

ARCOS réalise la trempe dans des fours continus à atmosphère contrôlée, suivie d'un second traitement thermique appelé revenu. Ce processus consiste à chauffer l'acier à 250 °C afin d'éliminer les tensions internes causées par le refroidissement rapide de la trempe, qui pourraient fragiliser l'acier. Cela permet d'assurer des propriétés mécaniques uniformes sur l'ensemble du fil de l'outil.

La tempra è la fase più importante nel processo di fabbricazione di un utensile da taglio. Consiste nel trattamento termico dell'acciaio a una alta temperatura (circa 1070°C) e che viene mantenuta durante un tempo determinato (tempo di austenizzazione) e, in seguito producendo un rapido raffreddamento a temperatura ambiente, ottenendo in questo modo la trasformazione della struttura molecolare dell'acciaio (reazione martensitica) che si manifesta ottenendo un aumento della durezza dell'acciaio. La durezza è la qualità fisica necessaria per ottenere un buon potere e una durabilità nel tempo del taglio del coltello. Inoltre, la corretta struttura interna dell'acciaio ottiene una maggiore resistenza alla corrosione. ARCOS realizza il trattamento termico della tempra in forni continui ad atmosfera controllata, realizza una seconda fase di trattamento termico – chiamato rinvenimento – consistente in un riscaldamento fino a 250°C per eliminare qualsiasi tensione che potrebbe determinarsi con il raffreddamento rapido durante il processo di tempra, che può produrre fragilità nell'acciaio, garantendo le stesse proprietà meccaniche per tutta la lunghezza del filo dell'utensile.

A têmpera é a fase mais importante no processo de fabrico de uma ferramenta de corte. Consiste num tratamento térmico do aço a uma temperatura elevada (aproximadamente 1070°C), mantendo-a durante um certo tempo (tempo de austenização) e depois arrefecendo o rapidamente à temperatura ambiente, obtendo-se assim a transformação da estrutura molecular do aço (reação martensítica), que se manifesta por um aumento da dureza do aço. A dureza é a qualidade física necessária para um bom poder de corte e durabilidade da faca. Além disso, a estrutura interna correta do aço proporciona uma maior resistência à corrosão. ARCOS realiza o tratamento térmico de endurecimento em fornos contínuos com atmosfera controlada e depois realiza um segundo tratamento térmico - chamado revenimento - que consiste no aquecimento até 250°C, a fim de eliminar qualquer tensão criada pelo rápido arrefecimento da têmpera, que poderia causar fragilidade no aço, garantindo as mesmas propriedades mecánicas ao longo de toda a lâmina da ferramenta.

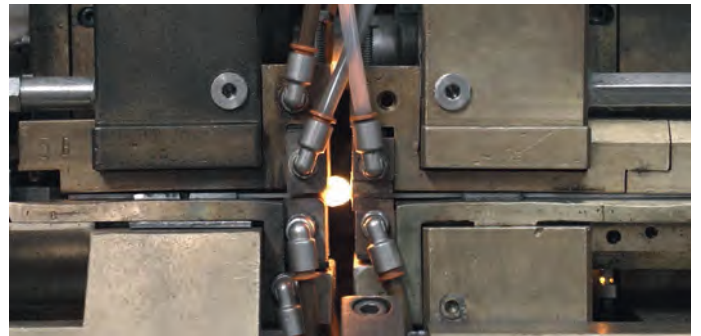



FORJADO

FORGING PROCESS · LA FORGE · LA FORGIATURA
FORJADO

El proceso de forja consiste en la deformación del acero, que previamente ha sido calentado al rojo vivo, entre dos utillajes denominados “estampas de forja”, las cuales llevan grabadas la forma del cuchillo a conseguir. Para obtener dicha deformación, se utilizan prensas de gran tonelaje, ya que es necesario un fuerte golpe para conseguir que se inicie el flujo plástico del acero para deformarse y obtenerse la forma grabada en las estampas. De este proceso hay que destacar que el cuchillo resultante es macizo de una sola pieza, evitando las indeseadas zonas soldadas, pegadas o huecas que son sinónimos de cuchillos de baja calidad, porque son zonas de baja resistencia mecánica, roturas y puntos posibles de oxidación.

The process of forge consists of the deformation of the steel, which previously has been warmed to red-hot, between two tools called “forging dies”, which have engraved the shape of the knife to be achieved. To obtain the above mentioned deformation, presses of great tonnage are used, since a strong blow is necessary to achieve that the plastic flow of the steel begins to be deformed and then becoming the form engraved in the dies. It is necessary in this process to distinguish that the resultant knife is a solid single piece, avoiding the unwanted welded, stuck and empty areas, which are synonymous of knives of low quality, because they are areas of low mechanical resistance, were breaks could be produced as well as potential points of oxidation.

Le processus de forge consiste à déformer l'acier, qui a été préalablement chauffé à blanc, entre deux matrices appelées “estampes de forge”, qui reproduisent la forme du couteau à obtenir. Pour réaliser cette déformation, on utilise des presses de grand tonnage, dans la mesure où une forte pression est nécessaire pour obtenir l'écoulement plastique de l'acier qui, devenu malléable, prendra la forme donnée par les estampes. Il est important de noter que le couteau obtenu à l'issue de ce processus est massif, fabriqué d'une seule pièce, ce qui évite les zones soudées, collées ou creuses, souvent caractéristiques des couteaux de mauvaise qualité, car elles sont des zones de faible résistance mécanique, susceptibles de casser ou de rouiller.

Il processo di forgiatura consiste nella deformazione dell'acciaio, che è stato preventivamente riscaldato a fuoco vivo, all'interno degli stampi denominati “stampi di forgiatura” che realizzano la forma determinata

del coltello. Per ottenere questa deformazione, vengono utilizzate presse di grande tonnellaggio, in quanto è necessario un colpo forte al fine di realizzare la fusione plastica per la deformazione dell'acciaio e ottenere in questo modo la forma prefissata dallo stampo. Con questo processo ottiene così un coltello in acciaio massiccio unipiece, evitando le zone saldate indesiderate, incollate o vuote, che sono indicative di bassa qualità, in quanto sono zone di bassa resistenza meccanica, con possibilità pure di rotture o punti possibili di ossidazione.

previamente aquecido em brasa entre duas ferramentas chamadas “matrizes de forjamento”, que são gravadas com a forma da faca a ser obtida. Para obter esta deformação, são utilizadas prensas de alta tonelagem, pois é necessário um forte golpe para iniciar o fluxo plástico do aço a fim de o deformar e obter a forma gravada nas matrizes. Deve-se salientar que a faca resultante é sólida numa só peça, evitando as áreas indesejáveis soldadas, coladas ou ocas que são sinónimo de facas de baixa qualidade, porque são áreas de baixa resistência mecânica, quebra e possíveis pontos de oxidação.



INYECCIÓN DIRECTA

DIRECT INJECTION · L'INJECTION DIRECTE
L'INIEZIONE DIRETTA · INJEÇÃO DIRETA

La inyección directa consiste en la unión de la espiga del cuchillo con el plástico del mango consiguiendo un conjunto sólido, robusto e inseparable. No existen huecos por donde pueda entrar agua o restos de alimentos, por lo que es un proceso totalmente higiénico, cumpliendo normativas de sanidad y seguridad. Se inyecta el plástico en estado líquido (180°C aprox.), en el molde. Así el plástico se solidifica alrededor de la espiga del cuchillo formando un bloque único (hoja-mango).

Direct injection consists of the union of the knife's tang with the plastic of the handle obtaining a durable, sturdy and unbreakable set. There are no gaps through which water or food remains can enter, reason why it is a completely hygienic process, complying with health and safety regulations. The plastic is injected in a liquid state (approx 180 °C) into the mold. In this fashion the plastic solidifies around the knife's tang forming a single block (blade-handle).

L'injection directe consiste à lier la soie du couteau au plastique du manche, créant ainsi un ensemble solide, robuste et indissociable. Il n'y a pas d'espaces où l'eau ou les résidus alimentaires pourraient pénétrer, ce qui garantit un processus entièrement hygiénique, conforme aux normes sanitaires et de sécurité. Le plastique est injecté à l'état liquide (environ 180°C) dans le moule. Ainsi, le plastique se solidifie autour de la soie du couteau, formant un bloc unique (lame-manche).

L'iniezione diretta consiste nell'unione del codolo del coltello con la plastica del manico, ottenendo un insieme solido, robusto e indivisibile. Non ci sono vuoti in cui possano entrare acqua o resti di alimenti, perciò è un processo completamente igienico, che rispetta le normative di sanità e sicurezza. Si inietta la plastica allo stato liquido (180°C circa) nello stampo. In questo modo la plastica si solidifica attorno al codolo del coltello, formando un blocco unico (lama-manico).

A injeção direta consiste em unir a espiga da faca com o plástico do cabo, criando assim um cabo sólido, robusto e inseparável. Não há buracos através dos quais possam entrar restos de água ou alimentos, pelo que é um processo totalmente higiénico, cumprindo os regulamentos de saúde e segurança. O plástico é injetado no molde em estado líquido (aprox. 180oC). O plástico solidifica em torno da espiga da faca, formando um único bloco (cabo-lâmina).

DOBLE INYECCIÓN

DOUBLE INJECTION · DOUBLE INJECTION · DOPPIA
INIEZIONE · INJEÇÃO DUPLA

La doble inyección es un proceso especial para formar el mango de un cuchillo, donde utilizamos una máquina de inyección directa con dos husillos. Este sistema de doble inyectado nos permite usar dos plásticos diferentes en el mango. En Arcos hemos desarrollado series con esta técnica: Colour PRO, Dúo PRO y Línea. En estas series inyectamos en la parte interior POLIPROPILENO, material duro que otorga fuerza y seguridad en la unión de mango-hoja; y CAUCHO en la parte exterior, material blando y no higroscópico (no absorbe líquidos), que otorga al cuchillo un tacto suave y una forma ergonómica, para que se adapte a la mano y sea cómodo para un uso prolongado.

Double injection is a special process that shapes the knife handle, using a direct injection moulding machine with two spindles. This double-injection system enables us to use two different plastic materials for the handle. At Arcos, we have developed series using this technique: Colour PRO, Dúo PRO, and Línea. In these series, POLYPROPYLENE, a hard material that strengthens the joint between the blade and the handle, providing greater safety, is injected into the interior of the handle, while RUBBER, a soft and non-hygroscopic material (it does not absorb liquids), is moulded onto the exterior. This gives the knife a soft feel and an ergonomic shape, allowing it to adapt comfortably to the hand for prolonged use.

L'injection double est un procédé spécial utilisé pour fabriquer le manche d'un couteau, où l'on utilise une machine à injection directe avec deux vis. Ce système permet d'employer deux plastiques différents pour le manche. Chez Arcos, nous avons développé trois collections avec cette technique : Colour PRO, Dúo PRO et Línea. Dans ces trois collections, nous injectons du POLYPROPYLENE à l'intérieur, un matériau rigide qui assure la solidité et la sécurité de l'assemblage entre le manche et la lame, et du CAOUTCHOUC à l'extérieur, un matériau souple et non hygroscopique (qui n'absorbe pas les

liquides), qui donne au couteau une prise en main agréable et une forme ergonomique, garantissant ainsi un confort optimal pour un usage prolongé.

La doppia iniezione è un processo speciale per formare il manico di un coltello, in cui utilizziamo una macchina a iniezione diretta con due viti. Questo sistema a doppia iniezione ci permette di utilizzare due plastiche diverse nel manico. In Arcos abbiamo sviluppato serie con questa tecnica: Colour PRO, Dúo PRO e Línea. In queste serie, iniettiamo POLIPROPILENE nella parte interna, un materiale duro che dona forza e sicurezza all'unione tra manico e lama; e GOMMA nella parte esterna, un materiale morbido e non igroscopico (non assorbe liquidi), che conferisce al coltello un tocco morbido e una forma ergonomica, in modo che si adatti alla mano e sia comodo per un uso prolungato.

A dupla injeção é um processo especial para formar o cabo de uma faca, no qual utilizamos uma máquina de injeção direta com dois fusos. Esse sistema de dupla injeção nos permite usar dois plásticos diferentes no cabo. Na Arcos, desenvolvemos séries com essa técnica: Colour PRO, Dúo PRO e Línea. Nessas séries, injetamos POLIPROPILENO na parte interna, um material rígido que proporciona força e segurança na união entre cabo e lâmina; e BORRACHA na parte externa, um material macio e não higroscópico (não absorve líquidos), que dá à faca um toque suave e um formato ergonômico, adaptando-se à mão e sendo confortável para uso prolongado.



NITRUM®

NITRUM® es la fórmula de acero al nitrógeno, ecológica y disponible solamente en los cuchillos ARCOS. NITRUM® proporciona más dureza¹, mayor poder de corte² y mejora la durabilidad del filo³. Su nueva microestructura marca la diferencia en el rendimiento de los cuchillos, tanto para un uso profesional como doméstico. El proceso de producción de NITRUM® respeta el medioambiente. El nitrógeno se encuentra en la atmósfera, y su proceso de enriquecimiento no tiene efectos negativos en el aire, agua o tierra.

NITRUM® is a Nitrogen enriched, eco-friendly stainless steel formula, available exclusively on ARCOS knives. With its improved hardness¹, enhanced cutting power², improved edge durability³, and improved Microstructure, NITRUM® can make the difference in the performance of knives for both professional and non-professional users. The NITRUM® production process is friendly with the environment. Nitrogen is readily available in the atmosphere, and its stainless steel enrichment process has no negative effect on the air, water or soil.

NITRUM® est la formule d'acier enrichi au nitrogène, écologique et disponible seulement dans les couteaux ARCOS. NITRUM® confère plus de dureté¹, un plus grand pouvoir de coupe² et une meilleure durabilité du fil³. Sa nouvelle microstructure marque la différence en terme de rendement

des couteaux destinés à être utilisés tant dans le cadre professionnel que domestique. Le procédé de production du NITRUM® respecte l'environnement. L'azote est présent dans l'atmosphère, et son procédé d'enrichissement n'a aucun impact sur l'air, l'eau ou la terre.

NITRUM® è la formula di acciaio al nitrogeno, ecologica ed disponibile soltanto nei coltelli ARCOS. NITRUM® Produce più durezza¹ maggior potere di taglio² e migliora la durabilità nel tempo del filo³. La sua nuova microstruttura marca la differenza nel rendimento dei coltelli, sia nell' utilizzo professionale che casalingo. Il processo di produzione del NITRUM® è ecocompatibile. Il nitrogeno è presente nella atmosfera ed il suo processo di arricchimento non produce effetti negativi nell'aria, nell'acqua e nella terra.

NITRUM® é a fórmula de aço de nitrogénio amigo do ambiente disponível apenas em facas ARCOS. NITRUM® proporciona maior dureza¹, maior poder de corte² e maior durabilidade da lâmina³. A sua nova microestrutura faz a diferença no desempenho das facas tanto para uso profissional como doméstico. O processo de produção do NITRUM® é amigo do ambiente. O nitrogénio encontra-se na atmosfera, e o seu processo de enriquecimento não tem efeitos negativos no ar, água ou solo.

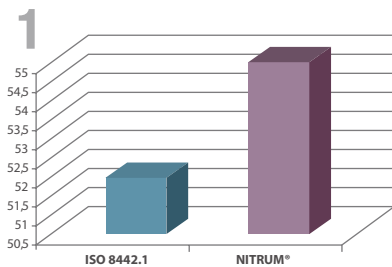

TEST DE DUREZA ISO 8442.1
HARDNESS TEST ISO 8442.1
TEST DE DURETÉ ISO 8442.1
TEST DI DUREZZA ISO 8442.1
ИСПЫТАНИЕ НА ТВЕРДОСТЬ ISO 8442.1

¹ Mejora la Dureza:

NITRUM® sobrepasa la norma ISO 8442-1 en más de 3 HRC.

¹ Improved Hardness:

NITRUM® exceeds the ISO 8442-1 norm by more than 3 HRC.

¹ Améliore la dureté:

NITRUM® surpasse la norme ISO 8442-1 de plus de 3 HRC (dureté Rockwell).

¹ Migliora la Durezza:

NITRUM® supera la norma 8442.1 di oltre 3 HRC.

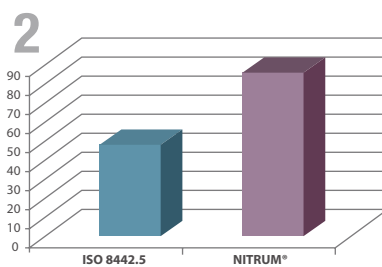

PODER DE CORTE INICIAL ISO 8442.5
INITIAL CUTTING POWER I ISO 8442.5
POUVOIR DE COUPE INITIAL CONFORME ISO 8442.5
TEST DI DUREZZA ISO 8442.5
НАЧАЛЬНАЯ РЕЖУЩАЯ СПОСОБНОСТЬ ISO 8442.5

² Mayor Poder de Corte Inicial:

NITRUM® supera la norma ISO 8442-5 en más de un 70%.

² Enhanced Initial Cutting Power:

NITRUM® tested 70% higher than the ISO 8442-5 norm.

² Pouvoir de coupe initial supérieur:

NITRUM® surpasse la norme ISO 8442-5 de plus de 70 %.

² Maggiore Potere di Taglio Iniziale:

NITRUM® supera la norma ISO 8442.5 di oltre il 70%.

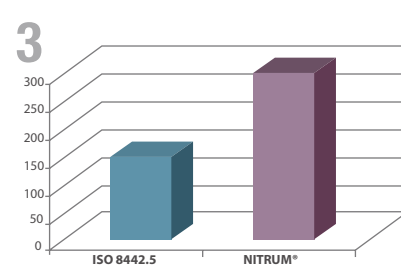

DURABILIDAD DEL FILO ISO 8442.5
CUTTING EDGE RETENTION (EDGE DURABILITY) ISO 8442.5
TEST DE DURETÉ ISO ISO 8442.5
TEST DI DUREZZA ISO ISO 8442.5
ИСПЫТАНИЕ НА ТВЕРДОСТЬ ISO ISO 8442.5

³ Durabilidad:

NITRUM® supera en más de un 200% la norma ISO 8442-5.

³ Edge Durability:

NITRUM® tested 200% higher than the ISO 8442-5 norm.

³ Durabilité :

NITRUM® surpasse la norme ISO 8442-5 de plus de 200 %.

³ Durabilità:

NITRUM® supera di oltre il 200% la norma ISO 8442.5.



Alta tecnología para una completa protección bacteriostática en nuestros cuchillos.

Se trata de la integración en su mango de una sofisticada tecnología con base de plata, Bactiproof Silver, para detener la proliferación de bacterias y proporcionar un extra de higiene y seguridad.

Este sistema actúa como un potente inhibidor de bacterias, gérmenes, mohos y hongos. De este modo, el mango del cuchillo cuenta con los agentes necesarios para proteger el plástico de la aparición de manchas, olores y de microorganismos perjudiciales para la salud. En definitiva, actúa como el complemento perfecto para la cocina, un ambiente donde la higiene es fundamental. Bactiproof Silver reduce en un 99,9% la presencia de bacterias, hongos y moho en la superficie del mango. Además, su rendimiento antimicrobiano permanece constante durante toda la vida útil del cuchillo.

High technology for the complete bacteriostatic protection of our knives. The integration of silver based sophisticated technology Bactiproof Silver into the handles of these knives prevents the spread of bacteria and provides additional hygiene and safety.

This system acts as a powerful inhibitor against bacteria, germs, mould and fungi. The knife handle now has the necessary agents to protect the plastic against the appearance of stains, smells and microorganisms which are harmful to the health. In short, it is the perfect complement for the kitchen, an environment where hygiene is essential. Bactiproof Silver reduces the presence of bacteria, fungi and mould by 99.9% on the surface of the handle. Moreover, its antimicrobial performance remains constant throughout the useful lifetime of the knife.

Haute technologie pour une protection bactériostatique totale de nos couteaux.

Il s'agit de l'intégration, au niveau du manche, d'une technologie sophistiquée à base d'argent, Bactiproof Silver, capable de freiner la prolifération de bactéries et offrant davantage d'hygiène et de sécurité.

Ce système est un puissant inhibiteur de bactéries, de germes, de moisissures et de champignons. Ainsi, le manche du couteau est doté des agents nécessaires à la protection du plastique contre l'apparition de taches, d'odeurs et de microorganismes nocifs pour la santé. En somme, c'est le complément idéal pour la cuisine, un milieu où l'hygiène est essentielle. Bactiproof Silver réduit de 99,9 % la présence de bactéries, de champignons et de moisissures sur la surface du manche. De plus, ses propriétés anti-microbes restent constantes pendant toute la durée de vie du couteau.

Alta tecnologia per una protezione batteriostatica totale dei nostri coltelli. L'inserimento nella composizione del manico di una sofisticata tecnologia a base d'argento, la Bactiproof Silver, per impedire la proliferazione di batteri e garantire prestazioni eccellenti in quanto a igiene e sicurezza. Questo sistema funziona come un potente inibitore di batteri, germi, muffe e funghi. Di conseguenza, il manico del coltello dispone degli strumenti necessari per proteggere la plastica dall'apparizione di macchie, cattivi odori e microorganismi dannosi per la salute. In poche parole, è l'alleato perfetto per la tua cucina, un ambiente in cui l'igiene è fondamentale. Bactiproof Silver riduce del 99,9% la presenza di batteri, funghi e muffe sulla superficie del manico. Inoltre la sua capacità di impedire la proliferazione dei microbi si mantiene inalterata per tutta la vita del coltello.

Alta tecnologia para uma proteção bacteriostática completa nas nossas facas.

Refere-se à integração em seu cabo de uma sofisticada tecnologia à base de prata, Bactiproof Silver, para impedir a proliferação de bactérias e proporcionar uma higiene e segurança extra.

Este sistema atua como um poderoso inibidor de bactérias, germes, mofo e fungos. Dessa forma, o cabo da faca conta com os agentes necessários para proteger o plástico do aparecimento de manchas, odores e de microorganismos prejudiciais à saúde.

Em suma, atua como o complemento perfeito para a cozinha, um ambiente onde a higiene é fundamental. Bactiproof Silver reduz em 99,9% a presença de bactérias, fungos e mofo na superfície do cabo. Além disso, seu desempenho antimicrobiano permanece constante durante toda a vida útil da faca.



ICE PLUS

TRATAMIENTO TÉRMICO SUB-CERO "ICE-PLUS"

El tratamiento térmico sub-cero "Ice-Plus", aplicado en la serie Colour-Pro, consiste en un enfriamiento a -80°C, tras realizar el tradicional temple, con el objetivo de mejorar la estructura del acero inoxidable, eliminando el pequeño porcentaje de austenita residual. La estructura de acero que se obtiene otorga propiedades especiales al cuchillo, tanto de resistencia al impacto como al desgaste.

"ICE-PLUS" SUB-ZERO HEAT TREATMENT

The "Ice-Plus" sub-zero heat treatment applied to the Colour-Pro series consists in cooling material to -80°C, after the traditional tempering has been carried out, with the aim of improving the structure of the stainless steel, eliminating the small percentage of residual austenite. The structure of the steel that is obtained provides the knives with special properties which makes them resistant to both impact and wear.

TRAITEMENT THERMIQUE SUB-ZÉRO "ICE-PLUS"

Le traitement thermique sub-zéro "Ice-Plus" appliqué à la gamme Colour-Pro consiste dans un refroidissement à -80°C après la réalisation de la trempe traditionnelle, afin d'améliorer la structure de l'acier inoxydable, moyennant l'élimination du bas pourcentage d'austénite résiduelle. La structure en acier obtenue dote le couteau de certaines propriétés spéciales, aussi bien en termes de résistance aux chocs que d'usure.

TRATTAMENTO TERMICO SOTTOZERO "ICE-PLUS"

Il trattamento termico sottozero "Ice-Plus", che viene applicato alla serie Colour-Pro, consiste nel raffreddamento dell'acciaio inox a -80°C al fine di migliorarne la struttura, eliminando la scarsa percentuale di austenite residua al termine del processo di tempra.

La risultante struttura in acciaio conferisce al coltello speciali proprietà di resistenza, sia all'impatto che all'usura.

O TRATAMENTO TÉRMICO SUB-ZERO "ICE-PLUS", aplicado na série Colour-Pro, consiste num arrefecimento a -80°C, após realizar o tradicional endurecimento, com o objetivo de melhorar a estrutura do aço inoxidável, eliminando a pequena percentagem de austenite residual. A estrutura de aço obtida confere propriedades especiais à faca, tanto de resistência ao impacto como ao desgaste.

REMACHES



STAINLESS STEEL RIVETS · RIVETS INOX · RIVETTI IN ACCIAIO INOSSIDABILE · REBITES

El compromiso de mejora continua, que caracteriza a ARCOS desde su fundación, ha permitido la innovación constante de sus productos. Una de las mejoras ha consistido en la utilización de remaches de Acero Inoxidable, en lugar de los remaches de aluminio, utilizados hasta ahora. Estos nuevos remaches, además de mejorar el montaje de los mangos, gracias a una mayor fuerza de sujeción, aumentan extraordinariamente la resistencia a la corrosión, garantizando que nunca se suelten los mangos de los cuchillos por este fenómeno.

A commitment to continuous improvement, one of the main features of ARCOS from its foundation, has allowed the constant innovation of our products; being our achievement the use of Stainless Steel rivets, instead of aluminium rivets, as usual till now. These new rivets, apart from improving the assembly of handles thanks to a major subsection strength, increase extraordinarily their resistance to corrosion, guaranteeing that handles never come loose from the knives due to this reason.

La politique en matière d'innovation qui caractérise ARCOS a contribué de manière continue à l'amélioration de ses produits. La amélioration a consisté à préférer les rivets en acier inoxydable aux rivets en aluminium utilisés jusqu'alors. Ces nouveaux rivets, non seulement améliorent le montage des manches grâce à une meilleure force de serrage, mais augmentent également sensiblement la résistance à la corrosion ; les manches des couteaux ne risquent donc pas de présenter du jeu ou de se désolidariser de leur support sous l'effet de ce phénomène.

La ricerca per migliorare continuamente, che caratterizza ARCOS sin dal momento della sua fondazione, ha ottenuto il risultato di una innovazione continua dei suoi prodotti. Il miglioramento ottenuto, è stato l'inserimento di rivetti in acciaio inossidabile, sostituendo quelli in alluminio precedentemente utilizzati. Questi nuovi rivetti, oltre a migliorare e facilitare il montaggio dei manici, grazie ad una maggiore forza di assoggettamento, aumentano enormemente la resistenza alla corrosione, non permettendo mai il distacco del manico dalla lama, effetto questo dovuto principalmente alla corrosione stessa.

O compromisso com a melhoria contínua, que caracteriza a ARCOS desde a sua fundação, permitiu a inovação constante dos seus produtos. Uma das melhorias foi a utilização de rebites de Aço Inoxidável, em vez dos rebites de alumínio. Esses novos rebites, além de melhorar a montagem dos cabos, graças a uma maior força de sujeição, aumentam extraordinariamente a resistência à corrosão, garantindo que os cabos das facas nunca se soltam por este fenómeno.



FILO SEDA

SILK EDGE · SILK EDGE · FILO SETA · FIO SEDA

El Filo Seda nace de la combinación perfecta entre la tradición de nuestros maestros cuchilleros y la tecnología más innovadora, logrando un corte único con un acabado pulido y distintivo a lo largo del filo.

Este proceso artesanal consta de tres fases de afilado y pulido manual, que dan como resultado un corte suave, preciso y sorprendente, capaz de dejar huella en cada uso. Tras implementarse por primera vez en la serie Manhattan, el filo especial Seda se ha incorporado también a las series Brooklyn, Nórdika y Ópera, y alcanza su máxima expresión en la serie Eclipse con el nuevo Filo Seda Plus, una versión perfeccionada que eleva aún más su rendimiento y calidad.

The Silken Edge is born from the perfect combination of the tradition of our master knife makers and the most innovative technology, achieving a unique cut with a polished and distinctive finish along the edge. This artisanal process consists of three phases of manual sharpening and polishing, resulting in a smooth, precise, and impressive cut, capable of leaving its mark with every use. After being first implemented in the Manhattan series, the special Silken Edge has also been incorporated into the Brooklyn, Nórdika, and Ópera series, reaching its peak in the Eclipse series with the new Silken Plus Edge, a perfected version that further enhances its performance and quality.

Le fil Seda est né de la combinaison parfaite entre la tradition de nos maîtres couteliers et la technologie la plus innovante, obtenant ainsi une coupe unique avec une finition polie et distinctive tout au long du tranchant.

Ce processus artisanal comprend trois phases d'affûtage et de polissage manuels, aboutissant à une coupe douce, précise et impressionnante, capable de marquer chaque utilisation. Après avoir été introduit pour la première fois dans la série Manhattan, le fil spécial Seda a également été intégré aux séries Brooklyn, Nórdika et Ópera, atteignant son apogée dans la série Eclipse avec le nouveau fil Seda Plus, une version perfectionnée qui améliore encore ses performances et sa qualité.

Il Filo Seta nasce dalla perfetta combinazione tra la tradizione dei nostri maestri coltellinai e la tecnologia più innovativa, ottenendo un taglio unico con una finitura lucida e distintiva lungo tutto il filo. Questo processo artigianale consiste in tre fasi di affilatura e lucidatura manuale, che danno come risultato un taglio fluido, preciso e sorprendente, capace di lasciare il segno ad ogni utilizzo. Dopo essere stato introdotto per la prima volta nella serie Manhattan, lo speciale Filo Seta è stato integrato anche nelle serie Brooklyn, Nórdika e Ópera, raggiungendo la sua massima espressione nella serie Eclipse con il nuovo Filo Seta Plus, una versione perfezionata che ne esalta ulteriormente prestazioni e qualità.

O Fio Seda nasce da combinação perfeita entre a tradição dos nossos mestres cutelheiros e a mais inovadora tecnologia, conseguindo um corte único com um acabamento polido e distinto ao longo do fio. Este processo artesanal é composto por três fases de afiação e polimento manuais, resultando em um corte suave, preciso e impressionante, capaz de deixar sua marca em cada uso. Após ser implementado pela primeira vez na série Manhattan, o fio especial Seda também foi incorporado às séries Brooklyn, Nórdika e Ópera, alcançando sua máxima expressão na série Eclipse com o novo Fio Seda Plus, uma versão aprimorada que eleva ainda mais seu desempenho e qualidade.

NOVELTIES
NOUVEAUTÉS
NOVITÀ
NOVIDADES

NOVEDADES

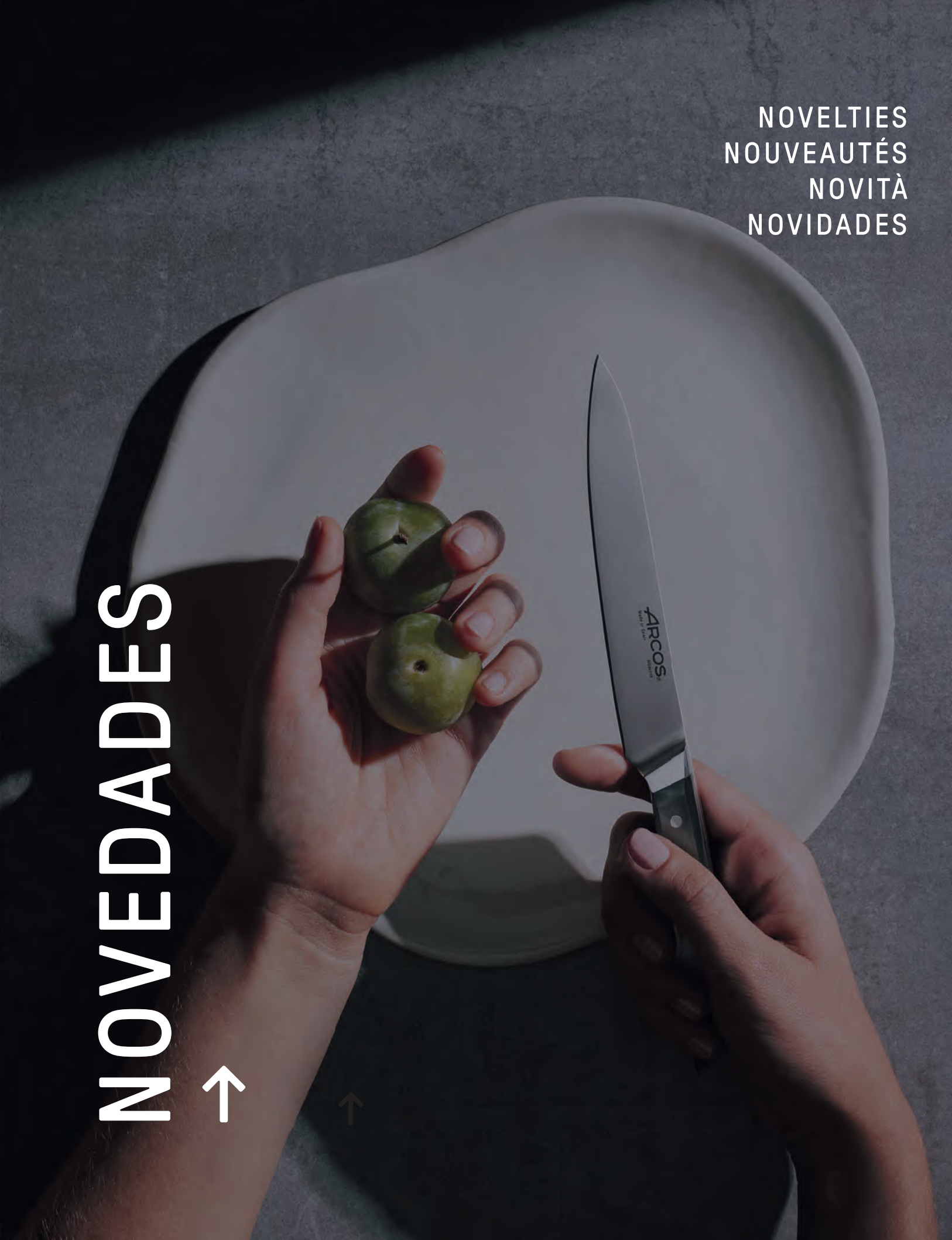

SERIE ECLIPSE



35 REF: 213000 100mm / 4"

Cuchillo Mondador / Paring Knife / Couteau Office
Spelucchino / Descascador



35 REF: 213200 130mm / 5"

Cuchillo Verduras / Vegetable Knife / Couteau Légumes
Coltello Verdura / Legumes



35 REF: 213400 150mm / 6"

Cuchillo Cocinero / Chef's Knife / Couteau Chef / Coltello
Cucina / Cozinheiro



35 REF: 213700 200mm / 8"

Panero (Sierra) / Bread Knife (Serrated) / Couteau Pain-
Pâtisserie (Cranté) / Coltello Pane (Seghettato) / Para Pão
(Perolado)



35 REF: 213500 200mm / 8"

Cuchillo Cocinero / Chef's Knife / Couteau Chef / Coltello
Cucina / Cozinheiro

SERIE SAMOA ICONIC



249 REF: 717224  16cm / 1,5l

Cazo Antiadherente de Aluminio Forjado / Forged Aluminum Non-Stick Saucepan / Casserole en Aluminium forgé Antiadhésif / Pentolino in Alluminio Forgiato Antiaderente Caçarola de Aluminio Forjado Antiaderente



250 REF: 717124  28cm / 4,3l

Cacerola Baja Antiadherente de Aluminio Forjado / Forged Aluminum Shallow Casserole / Sautoir en Aluminium Forgé Antiadhésif / Casseruola Bassa in Alluminio Forgiato Antiaderente / Caçarola Baixa de Aluminio Forjado



251 REF: 717222  16cm / 1,5l

Cazo Antiadherente de Aluminio Forjado / Forged Aluminum Non-Stick Saucepan / Casserole en Aluminium forgé Antiadhésif / Pentolino in Alluminio Forgiato Antiaderente Caçarola de Aluminio Forjado Antiaderente



252 REF: 717122  28cm / 4,3l

Cacerola Baja Antiadherente de Aluminio Forjado / Forged Aluminum Shallow Casserole / Sautoir en Aluminium Forgé Antiadhésif / Casseruola Bassa in Alluminio Forgiato Antiaderente / Caçarola Baixa de Aluminio Forjado Antiaderente



250

REF: 716924	⊘ 20cm / 2,6l
REF: 717024	⊘ 24cm / 4,3l

Cacerola Antiadherente de Aluminio Forjado / Forged
 Aluminum Non-Stick Casserole / Faitout en Aluminium Forgé
 Antiadhésif / Casseruola in Alluminio Forgiato Antiaderente
 Caçarola de Alumínio Forjado Antiaderente



249

REF: 716124	⊘ 20cm / 7,8"
REF: 716324	⊘ 24cm / 9,4"
REF: 716524	⊘ 28cm / 11"

Sartén Antiadherente de Aluminio Forjado / Poêle
 Antiadhésive en Aluminium Forgé / Padella Antiaderente
 in Alluminio Forgiato / Frigideira Antiaderente de Alumínio
 Forjado



252

REF: 716922	⊘ 20cm / 2,6l
REF: 717022	⊘ 24cm / 4,3l

Cacerola Antiadherente de Aluminio Forjado / Forged
 Aluminum Non-Stick Casserole / Faitout en Aluminium Forgé
 Antiadhésif / Casseruola in Alluminio Forgiato Antiaderente
 Caçarola de Alumínio Forjado Antiaderente



251

REF: 716122	⊘ 20cm / 7,8"
REF: 716322	⊘ 24cm / 9,4"
REF: 716522	⊘ 28cm / 11"

Sartén Antiadherente de Aluminio Forjado / Poêle
 Antiadhésive en Aluminium Forgé / Padella Antiaderente
 in Alluminio Forgiato / Frigideira Antiaderente de Alumínio
 Forjado

SERIE DÚO PRO



147 REF: 201000 140mm / 5"

Cuchillo Deshuesador Rígido / Rigid Boning Knife / Couteau à désosser Rigide / Coltello Disosso Rigido / Faca para Desossar Rígida



147 REF: 201100 140mm / 5"

Cuchillo Deshuesador Semirrígido / Semi-flexible Boning Knife / Couteau à Désosser Semi-flexible / Coltello Disosso Semiflessibile / Faca para Desossar Semiflexível.



147 REF: 201200 140mm / 5"

Cuchillo Deshuesador Rígido / Rigid Boning Knife / Couteau à Désosser Rigide / Coltello Disosso Rigido / Faca para Desossar Rígida



147 REF: 201300 140mm / 5"

Cuchillo Deshuesador Semirrígido / Semi-flexible Boning Knife / Couteau à Désosser Semi-flexible / Coltello Disosso Semiflessibile / Faca para Desossar Semiflexível.



147 REF: 201400 160mm / 6"

Cuchillo Deshuesador Rígido / Rigid Boning Knife / Couteau à désosser Rigide / Coltello Disosso Rigido / Faca para Desossar Rígida



147 REF: 201500 160mm / 6"

Cuchillo Deshuesador Semirrígido / Semi-flexible Boning knife / Couteau à Désosser Semi-flexible / Coltello Disosso Semiflessibile / Faca para Desossar Semiflexível.



147 REF: 201600 160mm / 6"

Cuchillo Deshuesador Rígido / Rigid Boning Knife / Couteau à Désosser Rigide / Coltello Disosso Rigido / Faca para Desossar Rígida



147 REF: 201700 160mm / 6"

Cuchillo Deshuesador Semirrígido / Semi-flexible Boning Knife / Couteau à Désosser Semi-flexible / Coltello Disosso Semiflessibile / Faca para Desossar Semiflexível.



148 REF: 202000 180mm / 7"

Cuchillo Carnicero / Butcher Knife / Couteau à Parer / Coltello Macellaio / Faca de Carniceiro



148 REF: 202100 200mm / 8"

Cuchillo Carnicero / Butcher Knife / Couteau à Parer / Coltello Macellaio / Faca de Carniceiro



148 REF: 202200 200mm / 8"

Cuchillo Carnicero Curvo / Curved Butcher Knife / Couteau à Parer Courbé / Coltello Macellaio Curvo / Faca de Carniceiro Curvada



148 REF: 202300 220mm / 8"

Cuchillo Carnicero Recto / Recta Butcher Knife / Couteau à Parer Droit / Coltello Macellaio Retto / Faca de Carniceiro Reta

SERIE DÚO PRO



149 REF: 202500 250mm / 10"

Cuchillo Carnicero Recto / Recta Butcher Knife / Couteau à Parer Droit / Coltello Macellaio Retto / Faca de Carniceiro Reta



149 REF: 202400 220mm / 8"

Cuchillo Carnicero Curvo / Curved Butcher Knife / Couteau à Parer Courbé / Coltello Macellaio Curvo / Faca de Carniceiro Curvada



149 REF: 202600 250mm / 10"

Cuchillo Carnicero Curvo / Curved Butcher Knife / Couteau à Parer Courbé / Coltello Macellaio Curvo / Faca de Carniceiro Curvada

SETS NOVA



100 REF: 187100 85mm / 3"

Set 2 Piezas / 2 Pieces Set / Set 2 Ctx. / Set 2 Pezzi
Conjunto 2 Peças



100 REF: 187200 100mm / 4"

Set 2 Piezas / 2 Pieces Set / Set 2 Ctx. / Set 2 Pezzi
Conjunto 2 Peças

SERIE LÍNEA



89 REF: 373651 100mm / 4"

Cuchillo Outdoor (Dentado) Verde / Outdoor Knife (Serrated) Green / Couteau Outdoor (Microdenté) Vert / Coltello Outdoor (Dentato) Verde / Faca Outdoor (Serrilhada) Verde



89 REF: 373652 100mm / 4"

Cuchillo Outdoor (Dentado) Rojo / Outdoor Knife (Serrated) Red / Couteau Outdoor (Microdenté) Rouge / Coltello Outdoor (Dentato) Rosso / Faca Outdoor (Serrilhada) Vermelho



89 REF: 373656 100mm / 4"

Cuchillo Outdoor (Dentado) Naranja / Outdoor Knife (Serrated) Orange / Couteau Outdoor (Microdenté) Orange / Coltello Outdoor (Dentato) Arancione / Faca Outdoor (Serrilhada) Laranja



89 REF: 849000 100mm / 4"





Set 3 Piezas / 3 Pieces Set / Set 3 Ctx. / Set 3 Pezzi / Conjunto 3 Peças

GREGORIO ARCOS



189 REF: 378800 16 PIEZAS

Estuche 16 Piezas / 16 Pieces Set / Ménagère 16 Pièces
Confezione 16 Pezzi / Conjunto 16 Peças

	4 X 371500	16
	4 X 371700	
	4 X 371600	
	4 X 371400	



CUBERTERÍA LISBOA



205 REF: 596400 202mm / 8"

Tenedor Arroz / Rice Fork / Gargo de arroz / Gargo de Arroz
Fourchette à Riz / Forchetta Riso



COMPLEMENTOS



312 REF: 607600

ACERO INOXIDABLE /
STAINLES STEEL

Sacacorchos Electrico / Electric Corkscrew / Tire-Bouchon
Électrique / Cavatappi Elettrico / Saca-Rolhas Elétrico



UTENSILIOS



284 REF: 685700 338mm / 13"

Espátula de Acero Inoxidable y Silicona / Stainless Steel
And Silicone Spatula / Spatule en Acier Inoxydable et en
Silicone / Spatola In Acciaio Inossidabile E Silicone
Espátula De Aço Inoxidável E Silicone



KNIVES
COUTEAUX
COLTELLI
FACAS



SOTTIHONO



ECLIPSE
PÁG 33

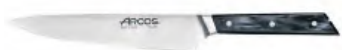

RIVIERA BLANC
PÁG 67



NOVA
PÁG 93



BROOKLYN
PÁG 37



CLARA
PÁG 73



UNIVERSAL PRO
PÁG 101



MANHATTAN
PÁG 43

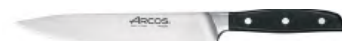

MAITRE
PÁG 77



COLOUR PRO
PÁG 119



ÓPERA
PÁG 49



NIZA
PÁG 82



2900 PRO
PÁG 127



NÓRDIKA
PÁG 55

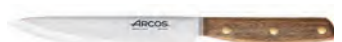

LÍNEA
PÁG 86



DÚO PRO
PÁG 145



RIVIERA
PÁG 61



LATINA
PÁG 90





SERIE ECLIPSE

Eclipse presenta un mango con patrones únicos e irrepetibles. Su diseño distintivo y bordes biselados, rompe con lo tradicional, aportando un carácter elegante y exclusivo a cada pieza. La hoja, afilada mediante el exclusivo proceso Filo Seda Plus, garantiza una precisión de corte inigualable.

Eclipse features a handle with unique and unrepeatable patterns. Its distinctive design and beveled edges break with tradition, bringing an elegant and exclusive character to each piece. The blade, sharpened through the exclusive Silk edge Plus process, ensures unmatched cutting precision.

Eclipse se distingue par un manche aux motifs uniques et inimitables. Son design, associé à une mitre biseautée, rompt avec la tradition pour offrir un caractère élégant et exclusif à chaque pièce. La lame, affûtée grâce au processus exclusif Silk Edge Plus, assure une précision de coupe inégalée.

Eclipse presenta un manico con motivi unici e irripetibili. Il suo design distintivo e i bordi smussati rompono con la tradizione, conferendo a ogni pezzo un carattere elegante ed esclusivo. La lama, affilata attraverso il processo esclusivo Filo Seta Plus, garantisce una precisione di taglio impareggiabile.

Eclipse apresenta um cabo com padrões únicos e irrepitíveis. Seu design distinto e bordas chanfradas rompem com o tradicional, trazendo um caráter elegante e exclusivo a cada peça. A lâmina, afiada através do exclusivo processo Fio Seda Plus, garante uma precisão de corte incomparável.

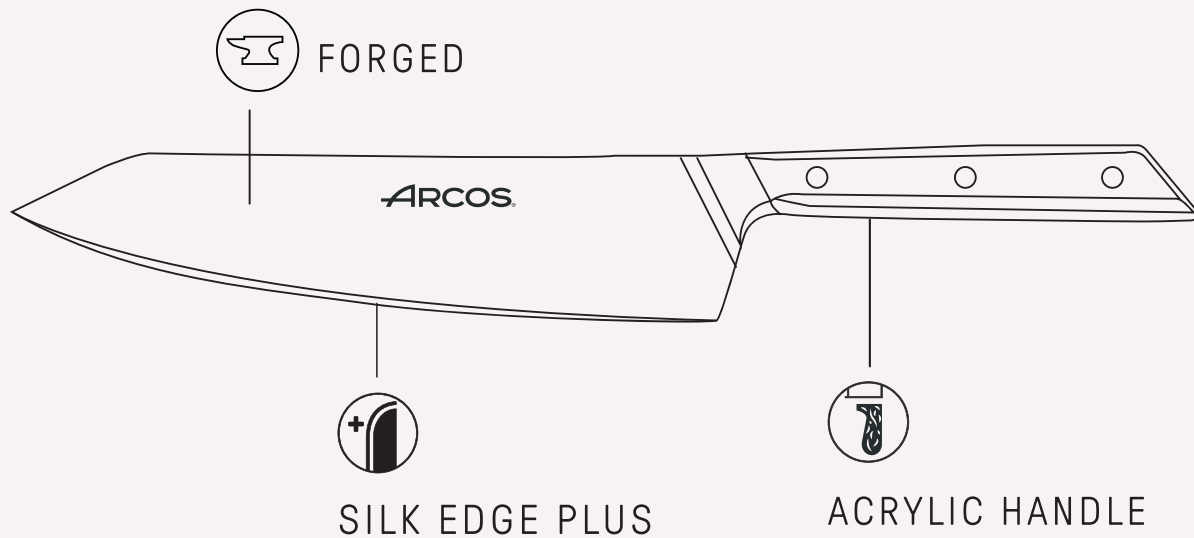

Forjado

Forged · Forgé · Forgiato · Forjado.

Acero Inoxidable Forjado NITRUM®

NITRUM® Forged Stainless Steel · Acier Inoxydable Forgé NITRUM® · Acciaio Inossidabile Forgiato NITRUM® · Aço Inoxidável Forjado NITRUM®.

Media Virola

Curved Bolster · Mitre Biseautée · Mezzo Nodo Forgiato Meia Virola.

Filo Seda Plus

Silk Edge Plus · Slik Edge Plus · Filo Seta Plus · Fio Seda Plus.

Recazo redondeado



Rounded Back · Dos de Lame Adouci · Costola Arrotondata Dorso Arredondado.

Mango Acrílico (PMMA)

Acrylic Handle (PMMA) · Manche en Acrylique (PMMA) · Manico In Acrilico (PMMA) · Mango Acrilico (PMMA).

Remaches de Acero Inox

Stainless Steel Rivets · Rivets en Acier Inoxydable · Rivetti in Acciaio Inossidabile · Rebites de Aço Inoxidável.

	Estuche	Case	Étui	Astuccio	Estojo
	Acero Inoxidable Forjado NITRUM® ACRÍLICO (PMMA)	NITRUM® Forged Stainless Steel ACRYLIC (PMMA)	Acier Inoxydable Forgé NITRUM® ACRYLIQUE (PMMA)	Acciaio Inossidabile Forgiato NITRUM® ACRILICO (PMMA)	Aço Inoxidável Forjado NITRUM® ACRÍLICO (PMMA)



NEW

213000

100mm / 4"
210mm / 8,2"

Mondador // Paring Knife
Couteau Office // Spelucchino
Descascador



NEW

213200

130mm / 5"
240mm / 9,4"

Verduras // Vegetable Knife
Couteau Légumes // Coltello
Verdura // Legumes



NEW

213400

150mm / 6"
260mm / 10,2"

Cocinero // Chef's Knife
Couteau Chef // Coltello Cucina
Cozinheiro



NEW

213500

200mm / 8"
340mm / 13,9"

Cocinero // Chef's Knife
Couteau Chef // Coltello Cucina
Cozinheiro



NEW

213700

200mm / 10"
340mm / 13,9"

Panero (Sierra) // Bread Knife
(Serrated) // Couteau Pain-
Pâtisserie (Cranté) // Coltello Pane
(Seghettato) // Para Pão (Perolado)



ARCOS
MADE IN SPAIN



SERIE BROOKLYN

Brooklyn es toda una invitación a cocinar, descubrir y, por supuesto, compartir. La textura de su mango de Micarta llevará el azul del Mediterráneo a tu cocina.

Brooklyn is a real invitation to cook, discover and, of course, share. The texture of its Micarta handle will bring the blue of the Mediterranean to your kitchen.

Brooklyn est une véritable invitation à cuisiner, à découvrir et, bien sûr, à partager. La texture de son manche en Micarta apportera le bleu de la Méditerranée à votre cuisine.

Brooklyn costituisce un vero invito a cucinare, scoprire e, ovviamente, condividere. La consistenza del suo manico di Micarta porterà l'azzurro del Mediterraneo nella vostra cucina.

Brooklyn é um convite para cozinhar, descobrir e, claro, partilhar. A textura do seu cabo em Micarta trará o azul do Mediterrâneo para a sua cozinha.

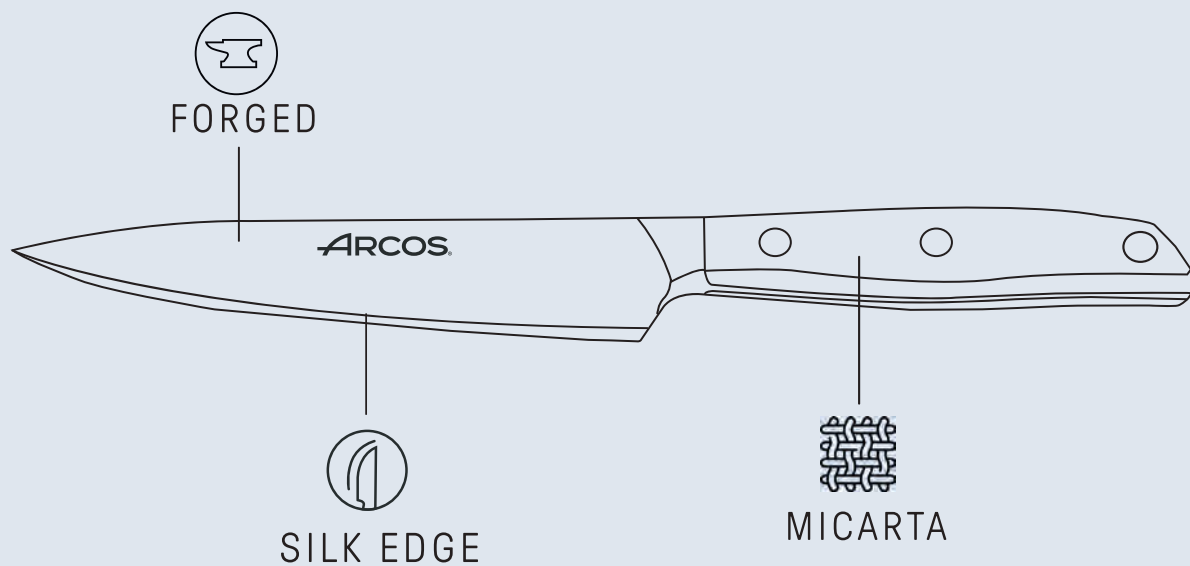

Forjado

Forged • Forgé • Forgiato • Forjado.

Acero Inoxidable Forjado NITRUM®

NITRUM® Forged Stainless Steel • Acier Inoxydable Forgé NITRUM® • Acciaio Inossidabile Forgiato NITRUM® • Aço Inoxidável Forjado NITRUM®.

Media Virola

Curved Bolster • Mitre Biseautée • Mezzo Nodo Forgiato
Meia Virola

Filo Seda

Silk Edge • Silk Edge • Filo Seta • Fio Seda.

Recazo redondeado

Rounded Back • Dos de Lame Adouci • Costola Arrotondata
Dorso Arredondado.

Micarta

Micarta Handle • Manche en MICARTA • Manico di MICARTA
Punho MICARTA.

Remaches de Acero Inox

Stainless Steel Rivets • Rivets en Acier Inoxydables • Rivetti
in Acciaio Inossidabile • Rebites de Aço Inoxidável.

	Estuche	Case	Étui	Astuccio	Estojo
	Acero Inoxidable Forjado NITRUM® MICARTA	NITRUM® Forged Stainless Steel MICARTA	Acier Inoxydable Forgé NITRUM® MICARTA	Acciaio Inossidabile Forgiato NITRUM® MICARTA	Aço Inoxidável Forjado NITRUM® MICARTA



190123

 100mm / 4"
209mm / 8,2"

Mondador // Paring Knife
Couteau Office // Spelucchino
Descascador



191123

 130mm / 5"
240mm / 9,4"

Verduras // Vegetable Knife
Couteau Légumes // Coltello
Verdura // Legumes



190423

 150mm / 6"
273mm / 10,7"

Cocinero // Chef's Knife
Couteau Chef // Coltello Cucina
Cozinheiro



190623

 210mm / 8"
353mm / 13,8"

Cocinero // Chef's Knife
Couteau Chef // Coltello Cucina
Cozinheiro



190823

 250mm / 10"
393mm / 15,4"

Cocinero // Chef's Knife
Couteau Chef // Coltello Cucina
Cozinheiro

	Estuche	Case	Étui	Astuccio	Estojo
	Acero Inoxidable forjado NITRUM® MICARTA	NITRUM® Forged Stainless Steel MICARTA	Acier Inoxydable Forgé NITRUM® MICARTA	Acciaio Inossidabile Forgiato NITRUM® MICARTA	Aço Inoxidável Forjado NITRUM® MICARTA



192023



Tomatero (Sierra) // Tomato Knife (Serrated) // Couteau Citron Tomate (Cranté) // Coltello Pomodoro (Seghettato) // Para Tomate (Perolado)



192623



Deshuesador // Boning Knife C. A Désosser // Coltello Disosso Para Desossar



191623

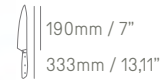

Rocking Santoku // Rocking Santoku Knife // C. Rocking Santoku // Coltello Rocking Santoku // Rocking Santoku



191323





Panero (Sierra) // Bread Knife (Serrated) // Couteau Pain (Cranté) // Coltello Pane (Seghettato) // Para Pão (Perolado)



191923



Jamonero // Slicing Knife (Flexible) C. Jambon (Flexible) // Coltello Prosciutto (Flessibile) // Para Presunto (Flexível)

	Estuche	Case	Étui	Astuccio	Estojo
	Acero Inoxidable forjado NITRUM® MICARTA	NITRUM® Forged Stainless Steel MICARTA	Acier Inoxydable Forgé NITRUM® MICARTA	Acciaio Inossidabile Forgiato NITRUM® MICARTA	Aço Inoxidável Forjado NITRUM® MICARTA



190123

190423

191623



858110

Set 3 piezas // 3 Pc. Set // Set 3 Ctx.
Set 3 Pezzi // Conjunto 3 Peças

	Caja Regalo	Gift Box	Boîte Cadeau	Scatola Regalo	Caixa de Presente
	Acero Inoxidable forjado Nitrum® MICARTA	NITRUM® Stainless Steel MICARTA	Acier Inoxydable NITRUM® MICARTA	Acciaio Inossidabile NITRUM® MICARTA	Aço Inoxidável NITRUM® MICARTA
	Madera de Caucho Lacada	Lacquered Rubber Wood	Bois de Caoutchouc Laqué	Legno di Caucciù Laccato	Madeira de Borracha Laqueada



784911

190123

190423

191623



194000

Juego 4 piezas // 4 pc. Set // Bloc 4
Pièces // Ceppo 4 Pezzi // Conjunto
4 Peças





SERIE MANHATTAN

Con la audacia y la imponente arquitectura neoyorquina como musa, la serie Manhattan destila estos elementos en cuchillos ideales para chefs que buscan perfección y precisión en cada plato. Un tributo a la cocina innovadora.

With the bold and impressive New York architecture as a muse, the Manhattan series displays these features in ideal knives for chefs who want perfection and precision in each dish. A tribute to innovative cooking.

Avec l'audace et l'imposante architecture new-yorkaise comme inspiration, la série Manhattan distille ces éléments dans des couteaux idéaux pour les chefs à la recherche de perfection et de précision dans chaque plat. Un hommage à la cuisine innovante.

Ispirata dalla musa dell'audacia e dell'imponente architettura newyorchese, la serie Manhattan distilla questi elementi in coltelli ideali per gli chef che aspirano alla perfezione e precisione in ogni piatto. Un tributo alla cucina innovatrice.

Com a audácia e a arquitetura imponente de Nova Iorque como musa, a série Manhattan destila estes elementos em facas ideais para chefs que procuram a perfeição e a precisão em cada prato. Uma homenagem à cozinha inovadora.

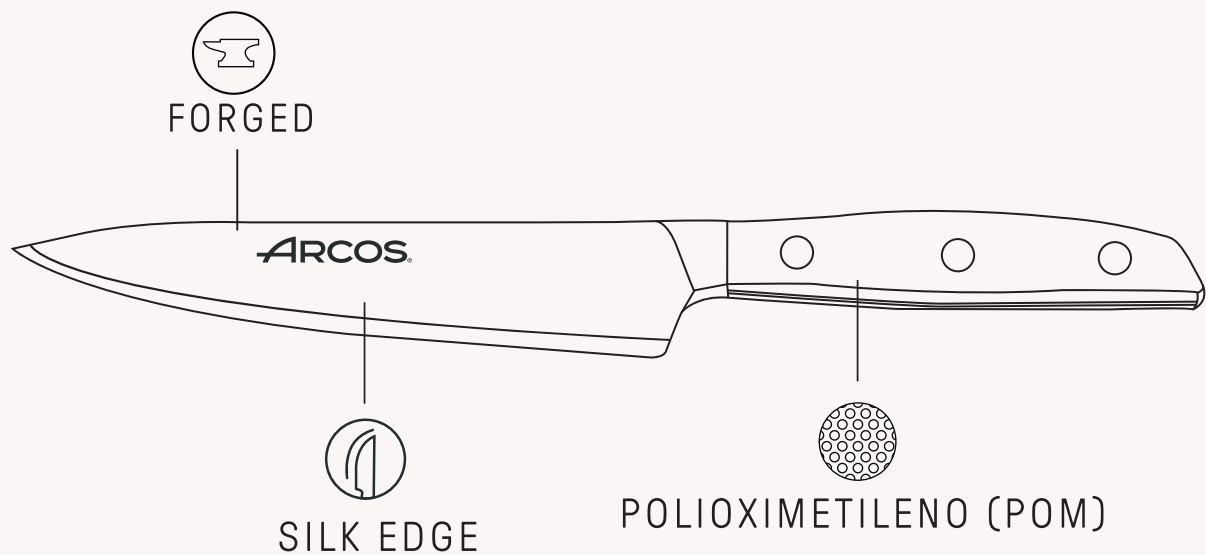

 **Forjado**

Forged • Forgé • Forgiato • Forjado.

Acero Inoxidable Forjado NITRUM®

NITRUM® Forged Stainless Steel • Acier Inoxydable Forgé NITRUM® • Acciaio Inossidabile Forgiato NITRUM® • Aço Inoxidável Forjado NITRUM®.

 **Recazo Redondeado**

Rounded Back • Dos de Lame Adouci • Costola Arrotondata Dorso Arredondado.

 **Filo Seda**

Silk Edge • Silk Edge • Filo Seta • Fio Seda.



 **Plásticos Técnicos (POM)**

Technical Plastics (POM) • Plastiques Techniques (POM) • Plastiche Tecniche (POM) • Plásticos Técnicos (POM).

Media Virola

Curved Bolster • Mitre Biseautée • Mezzo Nodo Forgiato Meia Virola

 **Bactiproof Silver®**

	Estuche	Case	Étui	Astuccio	Estojo
	Acero Inoxidable Forjado NITRUM® Polioximetileno (POM)	NITRUM® Forged Stainless Steel Polyoxymethylene (POM)	Acier Inoxydable Forgé NITRUM® Polyoxyméthylène (POM)	Acciaio Inossidabile Forgiato NITRUM® Polioximetileno (POM)	Aço Inoxidável Forjado NITRUM® Polioximetileno (POM)



160100

 100mm / 4"
210mm / 8,2"

Mondador // Paring Knife
Couteau Office // Spelucchino
Descascador



161100

 130mm / 5,1"
240mm / 9,4"

Verduras // Vegetable Knife
Couteau Légumes // Coltello
Verdura // Legumes



162000

 130mm / 5"
240mm / 9,4"

Tomatero (Sierra) // Tomato Knife
(Serrated) // C. Citron-Tomate
(Cranté) // Coltello Pomodoro
(Seghettato) // Para Tomato
(Perolado)



160400

 150mm / 6"
273mm / 10,7"

Cocinero // Chef's Knife
Couteau Chef // Coltello Cucina
Cozinheiro



160600

 210mm / 8"
353mm / 13,8"



Cocinero // Chef's Knife
Couteau Chef // Coltello Cucina
Cozinheiro



160800

 250mm / 10"
393mm / 15,4"

Cocinero // Chef's Knife
Couteau Chef // Coltello Cucina
Cozinheiro

	Estuche	Case	Étui	Astuccio	Estojo
	Acero Inoxidable Forjado NITRUM® Polioximetileno (POM)	NITRUM® Forged Stainless Steel Polyoxymethylene (POM)	Acier Inoxydable Forgé NITRUM® Polyoxyméthylène (POM)	Acciaio Inossidabile Forgiato NITRUM® Polioximetilene (POM)	Aço Inoxidável Forjado NITRUM® Polioximetileno (POM)



162600

 160mm / 6"
282mm / 11,1"

Deshuesador // Boning Knife
C. à Désosser // Coltello Disosso
Para Desossar



161300

 200mm / 8"
323mm / 12,7"

Panero (Sierra) // Bread Knife
(Serrated) // Couteau Pain (Cranté)
Coltello Pane (Seghettato) // Para
Pão (Perolado)



161400

 170mm / 7"
292mm / 11,4"

Lenguado (Flexible) // Sole
Knife (Flexible) // C. Filet de Sole
(Flexible) // Coltello Sogliola
(Flessibile) // Linguado (Flexível)



161600

 190mm / 7"
333mm / 13,11"

Rocking Santoku // Rocking
Santoku Knife // C. Rocking
Santoku // Coltello Rocking
Santoku // Rocking Santoku



161900

 250mm / 10"
372mm / 14,6



Jamonero // Slicing Knife (Flexible)
C. Jambon (Flexible) // Coltello
Prosciutto (Flessibile) // Para
Presunto (Flexível)



162300

 300mm / 12"
422mm / 16,6"

Jamonero // Slicing Knife (Flexible)
C. Jambon (Flexible) // Coltello
Prosciutto (Flessibile) // Para
Presunto (Flexível)

	Estuche	Case	Étui	Astuccio	Estojo
	Acero Inoxidable Forjado NITRUM® Polioximetileno (POM)	NITRUM® Forged Stainless Steel Polyoxymethylene (POM)	Acier Inoxydable Forgé NITRUM® Polyoxyméthylène (POM)	Acciaio Inossidabile Forgiato NITRUM® Polioximetileno (POM)	Aço Inoxidável Forjado NITRUM® Polioximetileno (POM)

858100



Set 3 piezas // 3 pc. Set // Set 3 Ctx.
Set 3 Pezzi // Conjunto 3 Peças



163200

Set 3 piezas // 3 pc. Set // Set 3 Ctx.
Set 3 Pezzi // Conjunto 3 Peças



	Estuche	Case	Étui	Astuccio	Estojo
	Acero Inoxidable Forjado NITRUM® Polioximetileno (POM)	NITRUM® Forged Stainless Steel Polyoxymethylene (POM)	Acier Inoxydable Forgé NITRUM® Polyoxyméthylène (POM)	Acciaio Inossidabile Forgiato NITRUM® Polioximetileno (POM)	Aço Inoxidável Forjado NITRUM® Polioximetileno (POM)
	Madera de Caucho	Rubber Wood	Bois de Caoutchouc	Legno di Caucciù	Madeira de Borracha



163300

Juego 4 piezas // 4 pc. Set // Bloc 4
Pièces // Ceppo 4 Pezzi // Conjunto
4 Peças



Arcos®
Made in Spain

Arcos®
Made in Spain

Arcos®
Made in Spain



SERIE OPERA

La definición de precisión. Ópera ofrece un filo seda revolucionario para cortes excepcionalmente suaves y precisos. Un indispensable en la cocina del chef moderno que aprecia la fusión de artesanía y tecnología avanzada.

The definition of precision. Ópera has a revolutionary silk edge for exceptionally smooth and precise cuts. An absolute must in the kitchen of a modern chef who appreciates the blend of craftsmanship and advanced technology.

La quintessence de la précision. Ópera propose un fil de lame révolutionnaire Silk Edge, pour des coupes exceptionnellement faciles et précises. Un incontournable dans la cuisine du chef moderne qui apprécie la symbiose entre savoir-faire artisanal et technologie de pointe.

La definizione della precisione. Ópera offre un filo di seta rivoluzionario per tagli eccezionalmente morbidi e precisi. Un imprescindibile nella cucina dello chef moderno che apprezza la fusione di artigianato e tecnologia avanzata.

A definição de precisão. Opera oferece um revolucionário fio de seda para cortes excepcionalmente suaves e precisos. Uma peça indispensável na cozinha do cozinheiro moderno que aprecia a fusão de artesanato e tecnologia avançada.

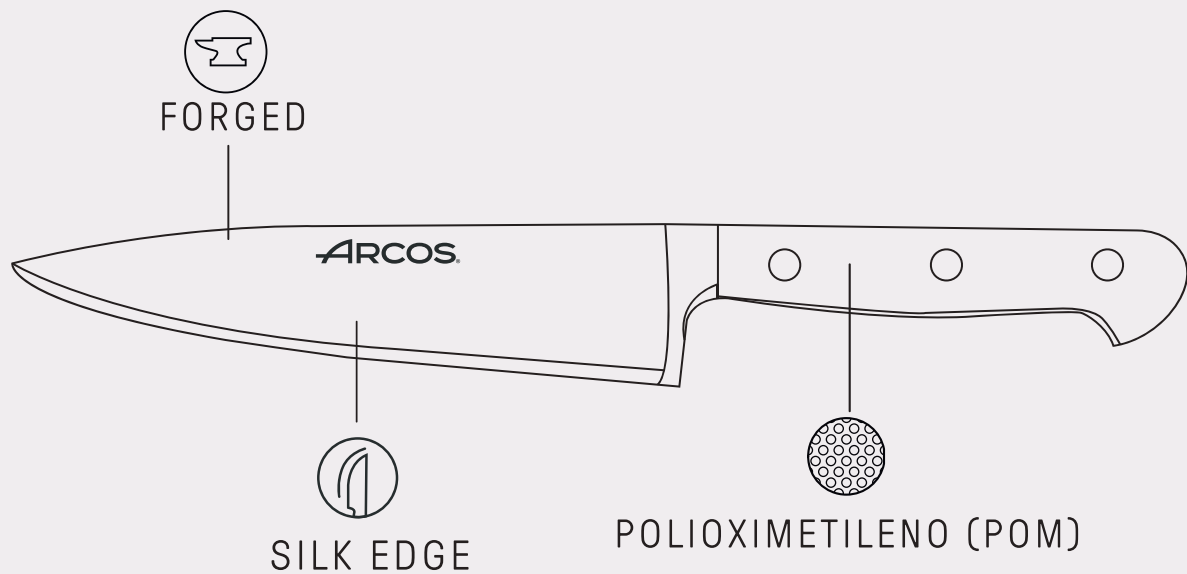

Forjado

Forged · Forgé · Forgiato · Forjado.

Acero Inoxidable Forjado NITRUM®

NITRUM® Forged Stainless Steel · Acier Inoxydable Forgé NITRUM® · Acciaio Inossidabile Forgiato NITRUM® · Aço Inoxidável Forjado NITRUM®.

Filo Seda

Silk Edge · Silk Edge · Filo Seta · Fio Seda.

Recazo redondeado

Rounded Back · Dos de Lame Adouci · Costola Arrotondata · Dorso Arredondado.



Plásticos Técnicos (POM)

Technical Plastics (POM) · Plastiques Techniques (POM) · Plastiche Tecniche (POM) · Plásticos Técnicos (POM).

Remaches de Acero Inox

Stainless Steel Rivets · Rivets en Acier Inoxydable · Rivetti in Acciaio Inossidabile · Rebites de Aço Inoxidável.

National Sanitary Foundation

	Estuche	Case	Étui	Astuccio	Estojo
	Acero Inoxidable forjado NITRUM® Polioximetileno (POM)	NITRUM® Forged Stainless Steel Polyoxymethylene (POM)	Acier Inoxydable Forgé NITRUM® Polyoxyméthylène (POM)	Acciaio Inossidabile Forgiato NITRUM® Polioximetileno (POM)	Aço Inoxidável Forjado NITRUM® Polioximetileno (POM)

225700

 100mm / 4"
214mm / 8,4"

Mondador // Paring Knife
C. Office // Spelucchino
Descascador

225600

 130mm / 5"
234mm / 9,2"

Tomatero (Sierra) // Tomato
Knife (Serrated) // Couteau
Citron-Tomate (Cranté) // Coltello
Pomodoro (Seghettato) // Para
Tomate (Perolado)

224900

 140mm / 5"
266mm / 10,4"

Cocinero // Chef's Knife
Couteau Chef // Coltello Cucina
Cozinheiro

226900

 140mm / 5"
267mm / 10,5"

Santoku (Con Alveolos)
Santoku Knife (Granton Edge)
C. Santoku (Alvéolé) // Coltello
Santoku (con Alveole) // Santoku
(com Alveolos)

226600

 180mm / 7"
307mm / 12"

Santoku (Con Alveolos)
Santoku Knife (Granton Edge)
C. Santoku (Alvéolé) // Coltello
Santoku (Con Alveole) // Santoku
(com Alveolos)

229900

 180mm / 7"
319mm / 12,5"

Rocking Santoku (Con Alveolos)
Rocking Santoku Knife (Granton
Edge) // C. Rocking Santoku
(Alvéolé) // Coltello Rocking
Santoku (con Alveole) // Rocking
Santoku (com Alveolos)

226400

 200mm / 8"
322mm / 12,6"

Panero (Sierra) // Bread Knife
(Serrated) // Couteau Pain (Cranté)
Coltello Pane (Seghettato) // Para
Pão (Perolado)

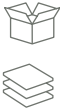

	Estuche	Case	Étui	Astuccio	Estojo
	Acero Inoxidable forjado NITRUM® Polioximetileno (POM)	NITRUM® Forged Stainless Steel Polyoxymethylene (POM)	Acier Inoxydable Forgé NITRUM® Polyoxyméthylène (POM)	Acciaio Inossidabile Forgiato NITRUM® Polioximetilene (POM)	Aço Inoxidável Forjado NITRUM® Polioximetileno (POM)



226200

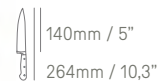

Deshuesador // Boning Knife
C. à Désosser // Coltello Disosso
Para Desossar



226500

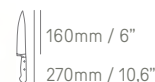

Deshuesador // Boning Knife
C. à Désosser // Coltello Disosso
Para Desossar



225900

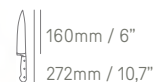

Fileteador // Fillet Knife // C. à
Découper // Coltello Filettare
Filetar



226000

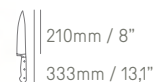

Fileteador // Fillet Knife // C. à
Découper // Coltello Filettare
Filetar



223300

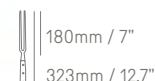

Tenedor Trinchante // Carving Fork
Fourchette // Forchettone// Garfo
Trinchante



225800

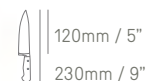



Chuletero // Steak Knife
Couteau Steak // Coltello Bistecca
Para Costoletas

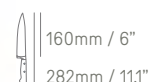

225000



Cocinero // Chef's Knife
Couteau Chef // Coltello Cucina
Cozinheiro

	Estuche	Case	Étui	Astuccio	Estojo
	Acero Inoxidable forjado NITRUM® Polioximetileno (POM)	NITRUM® Forged Stainless Steel Polyoxymethylene (POM)	Acier Inoxydable Forgé NITRUM® Polyoxyméthylène (POM)	Acciaio Inossidabile Forgiato NITRUM® Polioximetilene (POM)	Aço Inoxidável Forjado NITRUM® Polioximetileno (POM)



225100

 210mm / 8"
346mm / 13,6"

Cocinero // Chef's Knife
Couteau Chef // Coltello Cucina
Cozinheiro



225200

 230mm / 9"
365mm / 14,3"

Cocinero // Chef's Knife
Couteau Chef // Coltello Cucina
Cozinheiro



225300

 260mm / 10"
395mm / 15,5"

Cocinero // Chef's Knife
Couteau Chef // Coltello Cucina
Cozinheiro



226700

 250mm / 10"
372mm / 14,6"

Jamonero (Flexible) // Slicing Knife
(Flexible) // C. Jambon (Flexible)
Coltello Prosciutto (Flessibile)
Para Presunto (Flexível)



226800

 300mm / 12"
422mm / 16,6"

Jamonero (Flexible) // Slicing Knife
(Flexible) // C. Jambon (Flexible)
Coltello Prosciutto (Flessibile)
Para Presunto (Flexível)



2257



2249

2299



805900



Set 3 piezas // 3 Pc. Set // Set 3 Ctx.
Set 3 Pezzi // Conjunto 3 Peças

	Caja Regalo	Gift Box	Boîte Cadeau	Scatola Regalo	Caixa de Presente
	Acero Inoxidable forjado NITRUM® Polioximetileno (POM)	NITRUM® Forged Stainless Steel Polyoxymethylene (POM)	Acier Inoxydable Forgé NITRUM® Polyoxyméthylène (POM)	Acciaio Inossidabile Forgiato NITRUM® Polioximetilene (POM)	Aço Inoxidável Forjado NITRUM® Polioximetileno (POM)
	Madera de Haya Lacada Color Nogal	Walnut Lacquered Beech Wood	Bois de Hêtre Laqué Couleur Noyer	Legno di Faggio laccato in Color Noce	Madeira de Faia Lacada à Cor de Nogueira



227000

Juego 5 piezas // 5 Pc. Set // Bloc 5
Pièces // Ceppo 5 Pezzi // Conjunto
5 Peças

	Caja Regalo	Gift Box	Boîte Cadeau	Scatola Regalo	Caixa de Presente
	Acero Inoxidable forjado NITRUM® Polioximetileno (POM)	NITRUM® Forged Stainless Steel Polyoxymethylene (POM)	Acier Inoxydable Forgé NITRUM® Polyoxyméthylène (POM)	Acciaio Inossidabile Forgiato NITRUM® Polioximetilene (POM)	Aço Inoxidável Forjado NITRUM® Polioximetileno (POM)
	Madera de Caucho	Rubber Wood	Bois de Caoutchouc	Legno di Caucciù	Madeira de Borracha



228700

Juego 4 piezas // 4 Pc. Set // Bloc 4
Pièces // Ceppo 4 Pezzi // Conjunto
4 Peças



SÉRIE NÓRDIKA

Una serie que abraza la armonía de la naturaleza. Sus mangos de madera provienen de bosques sostenibles, perfectos para quienes buscan calidad, funcionalidad y respeto por el medio ambiente en su cocina.

A series that embraces the harmony of nature. The wood used to make their handles comes from sustainable forests, perfect for anyone who wants quality, practicality and respect for the environment in their kitchen.

Une série qui embrasse l'harmonie de la nature. Ses manches en bois sont issus de forêts durables, parfaits pour ceux qui recherchent la qualité, la fonctionnalité et le respect de l'environnement dans leur cuisine.

Una serie che accoglie l'armonia e la natura. I suoi manici in legno provengono da boschi sostenibili, perfetti per chi vuole qualità, funzionalità e rispetto per l'ambiente nella sua cucina.

Uma série que abraça a harmonia da natureza. Os seus cabos de madeira provêm de florestas sustentáveis, perfeitos para quem procura qualidade, funcionalidade e respeito pelo ambiente na sua cozinha.

EXCLUSIVE NITRUM®
STAINLESS STEEL

The wood of the NÓRDIKA Series
handles comes from well-managed
FSC® certified forests.

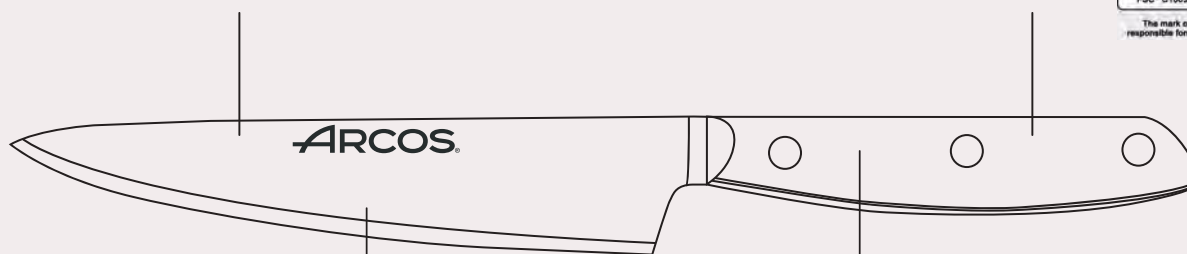

SILK EDGE



WOOD 100% FSC®



Acero Inoxidable NITRUM®

NITRUM® Stainless Steel · Acier Inoxydable NITRUM® · Acciaio Inossidabile NITRUM® · Aço Inoxidável NITRUM®.



Filo Seda

Silk Edge · Silk Edge · Filo Seta · Fio Seda.



Recazo Redondeado

Rounded Back · Dos de Lame Adouci · Costola Arrotondata · Dorso Arredondado.



Madera NATURAL

Natural Wood · Bois Naturel · Legno Naturale · Madeira Natural.





Remaches de Latón

Brass Rivets · Rivets en Laiton · Rivetti in Ottone · Rebites de Latão.



Packaging Reciclado

Recycled Packaging · Emballage Recyclé · Imballaggio Riciclato · Embalagem Reciclada.

	Estuche	Case	Étui	Astuccio	Estojo
	Acero Inoxidable NITRUM® Madera de Ovengkol	NITRUM® Stainless Steel Ovengkolwood	Acier Inoxydable NITRUM® Bois d'Ovangkol	Acciaio Inossidabile Forgiato NITRUM® Legno di Ovengkol	Aço Inoxidável Forjado NITRUM® Madeira de Ovengkol



164900

 100mm / 4"
230mm / 9"

Chuletero // Steak Knife
Couteau Steak // Coltello Bistecca
Para Costoletas



165000

 100mm / 4"
203mm / 8"

Mondador // Paring Knife
Couteau Office // Spelucchino
Descascador



166100

 125mm / 5"
240mm / 9,4"

Queso // Cheese Knife
Couteau Fromage // Coltello
Formaggio Queijo



165100

 130mm / 5"
240mm / 9,4"

Tomatero (Sierra)
Tomato Knife (Serrated)
Couteau Citron-Tomate (Cranté)
Coltello Pomodoro (Seghettato)
Para Tomate (Perolado)



165300

 170mm/6,6"
340mm/13,3"



Tenedor Trinchante // Carving Fork
Fourchette Diapason
Forchettone // Garfo Trinchante



165500

 200mm / 8"
340mm / 13,3"

Trinchante // Carving knife
Couteau à Découper // Coltello
Trinciante // Faca de trinchar

	Estuche	Case	Étui	Astuccio	Estojo
	Acero Inoxidable NITRUM® Madera de Ovengkol	NITRUM® Stainless Steel Ovengkolwood	Acier Inoxydable NITRUM® Bois d'Ovangkol	Acciaio Inossidabile Forgiato NITRUM® Legno di Ovengkol	Aço Inoxidável Forjado NITRUM® Madeira de Ovengkol



165400

 140mm / 5"
251mm / 9,8"

Cocinero // Chef's Knife
Couteau Chef // Coltello Cucina
Cozinheiro



165900

 160mm / 6"
270mm / 10,6"

Cocinero // Chef's Knife
Couteau Chef // Coltello Cucina
Cozinheiro



166800

 210mm / 8"
335mm / 13,1"

Cocinero // Chef's Knife
Couteau Chef // Coltello Cucina
Cozinheiro



166400

 200mm / 8"
317mm / 12,4"



Panero (Sierra)
Bread Knife (Serrated)
Couteau Pain (Cranté)
Coltello Pane (Seghettato)
Para Pão (Perolado)



166700

 250mm / 10"
315mm / 12,4"

Jamonero Flexible // Slicing Knife
(Flexible) // C. Jambon (Flexible)
Coltello Prosciutto (Flessibile)
Para Presunto (Flexível)

	Estuche	Case	Étui	Astuccio	Estojo
	Acero Inoxidable NITRUM® Madera de Ovengkol	NITRUM® Stainless Steel Ovengkolwood	Acier Inoxydable NITRUM® Bois d'Ovangkol	Acciaio Inossidabile Forgiato NITRUM® Legno di Ovengkol	Aço Inoxidável Forjado NITRUM® Madeira de Ovengkol



168100



 170mm / 7"
317mm / 12,4"

Deba // Deba Knife
C. Deba // Coltello Deba // Deba



168000



 175mm / 7"
320mm / 12,6"

Usuba // Usuba Knife // C. Usuba
Coltello Usuba // Usuba



166600



 190mm / 7"
315mm / 12,4"

Santoku // Santoku Knife
C. Santoku // Coltello Santoku
Santoku



168200



 240mm / 9"
383mm / 15"

Yanagiba // Yanagiba Knife
C. Yanagiba // Coltello Yanagiba
Yanagiba



1660

 60mm/2"
170mm/7"



1662

 135mm/5"
248mm/10"



1663

 130mm/5"
248mm/10"



167200

Set C. Queso 3 Pzas. // 3 Pc.
Cheese K. Set // Set C. Fromage 3
Pièces // Set Coltello Formaggio 3
Pezzi // Conjunto Queijo 3 Peças

	<p>Estuche</p> <p>Acero Inoxidable NITRUM® Madera de Ovengkol</p>	<p>Case</p> <p>NITRUM® Stainless Steel Ovengkolwood</p>	<p>Étui</p> <p>Acier Inoxydable NITRUM® Bois d'Ovangkol</p>	<p>Astuccio</p> <p>Acciaio Inossidabile Forgiato NITRUM® Legno di Ovengkol</p>	<p>Estojo</p> <p>Aço Inoxidável Forjado NITRUM® Madeira de Ovengkol</p>
---	---	---	---	--	---



1653 1655



167000

Set 2 piezas // 2 pc. Set // Set 2 pièces // Set 2 Pezzi // Conjunto 2 Peças



1650 1659 1668



167100

Set 3 piezas // 3 pc. Set // Set 3 Ctx. // Set 3 Pezzi // Conjunto 3 Peças



4 X 1649



167400

Set 4 piezas // 4 pc. Set // Set 4 Ctx. // Set 4 Pezzi // Conjunto 4 Peças



SERIE RIVIERA

En un tributo a la clásica elegancia francesa, la serie Riviera presenta su distinguida virola, fusionando arte y ergonomía en cada cuchillo forjado sin soldaduras, prometiendo no solo un corte, sino una experiencia culinaria.

In a tribute to the classic French elegance, the Riviera series presents its distinguished ferrule, uniting art and ergonomics in each knife forged without welding, promising not only a cut, but a culinary experience as well.

Hommage à la classique élégance française, la série Riviera dévoile sa mitre distinguée, fusionnant art et ergonomie dans chaque couteau forgé d'une seule pièce, promettant non seulement une coupe, mais une véritable expérience culinaire.

Come tributo alla classica eleganza francese, la serie Riviera presenta il suo particolare supporto che fonde arte ed ergonomia in ogni coltello forgiato senza saldature e che promette, non solamente un taglio, ma una vera esperienza culinaria.

Num tributo à elegância clássica francesa, a série Riviera apresenta uma virola distinta, fundindo arte e ergonomia em cada faca forjada sem soldagens, prometendo não apenas um corte, mas uma experiência culinária.

EXCLUSIVE NITRUM®
STAINLESS STEEL

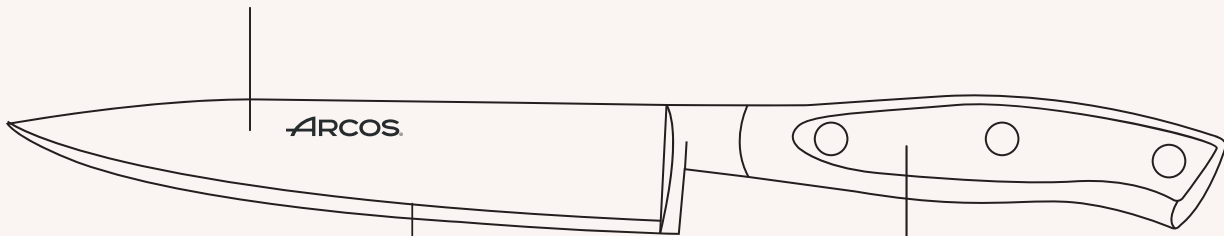

FORGED



POLIOXIMETILENO (POM)



Forjado

Forged • Forgé • Forgiato • Forjado.

Acero Inoxidable Forjado NITRUM®

NITRUM® Forged Stainless Steel • Acier Inoxydable Forgé NITRUM® • Acciaio Inossidabile Forgiato NITRUM® • Aço Inoxidável Forjado NITRUM®.

Plásticos Técnicos (POM)

Technical Plastics (POM) • Plastiques Techniques (POM) • Plastiche Tecniche (POM) • Plásticos Técnicos (POM).



Remaches de Acero Inox

Stainless Steel Rivets • Rivets en Acier Inoxydable • Rivetti In Acciaio Inossidabile • Rebites de Aço Inoxidável.

Virola con Diseño Francés

French Design Bolster • Mitre Design Français • Mitra Design Francese • Miter Design Francês.

Bactiproof Silver®

	Estuche	Case	Étui	Astuccio	Estojo
	Acero Inoxidable forjado NITRUM® Polioximetileno (POM)	NITRUM® Forged Stainless Steel Polyoxymethylene (POM)	Acier Inoxydable Forgé NITRUM® Polyoxyméthylène (POM)	Acciaio Inossidabile Forgiato NITRUM® Polioximetileno (POM)	Aço Inoxidável Forjado NITRUM® Polioximetileno (POM)

230200

 100mm / 4"
202mm / 7,9"

Mondador // Paring Knife
C. Office // Spelucchino
Descascador



230500

 130mm / 5"
230mm / 9"

Chuletero // Steak Knife
C. Steak // Coltello Bistecca
Para Costoletas



230600

 150mm / 6"
271mm / 10,6"

Cocina // Kitchen Knife
C. à Découper // Coltello Cucina
Cozinha



232000

 130mm / 5"
232mm / 9,1"

Tomatero (Sierra) // Tomato Knife
(Serrated) // Couteau Citron-
Tomates (Cranté) // Coltello
Pomodoro (Seghettato) // Para
Tomate (Perolado)



232800

 145mm / 6"
292mm / 11,4"

Queso // Cheese Knife
Couteau Fromage // Coltello
Formaggio // Queijo



233300

 180mm / 7"
320mm / 12,5"

Tenedor Trinchante // Carving Fork
Fourchette Diapason
Forchettone // Garfo Trinchante



	Estuche Acero Inoxidable forjado NITRUM® Polioximetileno (POM)	Case NITRUM® Forged Stainless Steel Polyoxymethylene (POM)	Étui Acier Inoxydable Forgé NITRUM® Polyoxyméthylène (POM)	Astuccio Acciaio Inossidabile Forgiato NITRUM® Polioximetileno (POM)	Estojo Aço Inoxidável Forjado NITRUM® Polioximetileno (POM)
---	--	--	--	--	---



233200



140mm / 5"
268mm / 10,5"

Santoku (Con Alveolos)
Santoku Knife (Granton Edge)
C. Santoku (Alvéolé) // Coltello
Santoku (Con Alveole) // Santoku
(com Alveolos)



233500



180mm / 7"
309mm / 12,1"

Santoku (Con Alveolos)
Santoku Knife (Granton Edge)
C. Santoku (Alvéolé) // Coltello
Santoku (Con Alveole) // Santoku
(com Alveolos)



233100



180mm / 7"
321mm / 12,5"

Rocking Santoku (Con Alveolos)
Rocking Santoku Knife (Granton
Edge) // C. Rocking Santoku
(Alvéolé) // Coltello Rocking
Santoku (Con Alveole) // Rocking
Santoku (com Alveolos)



233400

150mm / 6"
272mm / 10,7"

Cocinero // Chef's Knife
Couteau Chef // Coltello Cucina
Cozinheiro



233600

200mm / 8"
327mm / 12,8"

Cocinero // Chef's Knife
Couteau Chef // Coltello Cucina
Cozinheiro



233700

250mm / 10"
378mm / 14,8"



Cocinero // Chef's Knife
Couteau Chef // Coltello Cucina
Cozinheiro



233800

300mm / 12"
434mm / 17"

Cocinero // Chef's Knife
Couteau Chef // Coltello Cucina
Cozinheiro

	Estuche	Case	Étui	Astuccio	Estojo
	Acero Inoxidable forjado NITRUM® Polioximetileno (POM)	NITRUM® Forged Stainless Steel Polyoxymethylene (POM)	Acier Inoxydable Forgé NITRUM® Polyoxyméthylène (POM)	Acciaio Inossidabile Forgiato NITRUM® Polioximetileno (POM)	Aço Inoxidável Forjado NITRUM® Polioximetileno (POM)



231500

 130mm / 5,"
251mm / 9,8"

Deshuesador // Boning Knife
C. à Désosser // Coltello Disosso
Para Desossar



232900

 170mm / 7,"
291mm / 11,4"

Lenguado (Flexible) // Sole
Knife (Flexible) // C. Filet de Sole
(Flexible) // Coltello Sogliola
(Flessibile) // Linguado (Flexível)



233000

 200mm / 8,"
319mm / 12,5"

Fileteador // Fillet Knife // C. à
Découper // Coltello Filettare
Filetar



231300

 200mm / 8,"
323mm / 12,7"

Panero (Sierra) // Bread Knife
(Serrated) // Couteau Pain (Cranté)
Coltello Pane (Seghettato) // Para
Pão (Perolado)



231000

 250mm / 10,"
374mm / 14,7"

Jamonero (Flexible-Con Alveolos)
Slicing Knife (Flexible-Granton
Edge) // C. Jambon (Flexible-
Alvéole) // Coltello Prosciutto
(Flessibile-Con Alveole)
Para Presunto (Flexível com
Alveolos)



231100

 300mm / 11,"
418mm / 16,4"

Jamonero (Flexible) // Slicing Knife
(Flexible) // C. Jambon (Flexible)
Coltello Prosciutto (Flessibile)
Para Presunto (Flexível)

	Estuche	Case	Étui	Astuccio	Estojo
	Acero Inoxidable forjado NITRUM® Polioximetileno (POM)	NITRUM® Forged Stainless Steel Polyoxymethylene (POM)	Acier Inoxydable Forgé NITRUM® Polyoxyméthylène (POM)	Acciaio Inossidabile Forgiato NITRUM® Polioximetileno (POM)	Aço Inoxidável Forjado NITRUM® Polioximetileno (POM)

838310

Set 3 piezas // 3 pc. Set // Set 3 Ctx.
Set 3 Pezzi // Conjunto 3 Peças



2302 2334 2336





834200

Set 3 piezas // 3 pc. Set // Set 3 Ctx.
Set 3 Pezzi // Conjunto 3 Peças



2302 2334 2331



	Caja Regalo	Gift Box	Boîte Cadeau	Scatola Regalo	Caixa de Presente
	Acero Inoxidable forjado NITRUM® Polioximetileno (POM)	NITRUM® Forged Stainless Steel Polyoxymethylene (POM)	Acier Inoxydable Forgé NITRUM® Polyoxyméthylène (POM)	Acciaio Inossidabile Forgiato NITRUM® Polioximetileno (POM)	Aço Inoxidável Forjado NITRUM® Polioximetileno (POM)
	Madera de Haya	BeechWood	Bois de Hêtre	Legno di Faggio	Madeira de Faia

234200

Juego 6 piezas // 6 pc. Set // Bloc 6
Pièces // Ceppo 6 Pezzi // Conjunto
6 Peças



2302 2334 2336 2313 2310 2784



234300

Juego 5 piezas // 5 pc. Set // Bloc 5
Pièces // Ceppo 5 Pezzi // Conjunto
5 Peças



1853 2302 2336 2313 2310





SERIE RIVIERA BLANC

Con esta serie la pureza del blanco se funde con la precisión del acero. Cada cuchillo es una obra de arte, ofreciendo cortes exquisitos y una estética impecable que ilumina cualquier cocina.

With this series the white pureness blends in with the steel precision. Each knife is a work of art, making exquisite cuts, with an impeccable look that enlightens any kitchen.

Avec cette série, la pureté du blanc se mêle à la précision de l'acier. Chaque couteau devient une pièce d'art, offrant des coupes exquis et une esthétique impecable qui illumine toute cuisine.

In questa serie la purezza del bianco si fonde con la precisione dell'acciaio. Ogni coltello è un'opera d'arte che offre tagli squisiti e un'estetica impeccabile, per illuminare qualsiasi cucina.

Com esta série, a pureza do branco encontra-se com a precisão do aço. Cada faca é uma obra de arte, oferecendo cortes requintados e uma estética impecável que ilumina qualquer cozinha.

EXCLUSIVE NITRUM®
STAINLESS STEEL

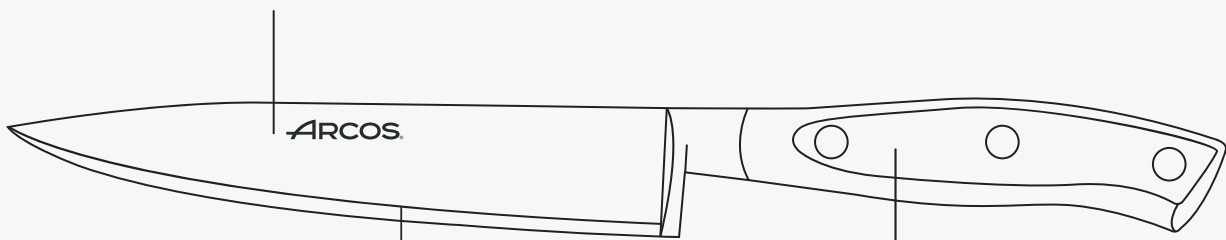

FORGED



POLIOXIMETILENO (POM)



Forjado

Forged · Forgé · Forgiato · Forjado.

Acero Inoxidable Forjado NITRUM®

NITRUM® Forged Stainless Steel · Acier Inoxydable Forgé
NITRUM® · Acciaio Inossidabile Forgiato NITRUM® · Aço
Inoxidável Forjado NITRUM®.

Plásticos Técnicos (POM)

Technical Plastics (POM) · Plastiques Techniques (POM)
Plastiche Tecniche (POM) · Plásticos Técnicos (POM).



Remaches de Acero Inox

Stainless Steel Rivets · Rivets en Acier Inoxydable · Rivetti
In Acciaio Inossidabile · Rebites de Aço Inoxidável.

Virola con Diseño Francés

French Design Bolster · Mitre Design Français · Mitra Design
Francese · Miter Design Francés.

Bactiproof Silver®

	Estuche	Case	Étui	Astuccio	Estojo
	Acero Inoxidable forjado NITRUM® Polioxiometileno (POM)	NITRUM® Forged Stainless Steel Polyoxymethylene (POM)	Acier Inoxydable Forgé NITRUM® Polyoxyméthylène (POM)	Acciaio Inossidabile Forgiato NITRUM® Polioxiometileno (POM)	Aço Inoxidável Forjado NITRUM® Polioxiometileno (POM)



230224

 100mm / 4"
202mm / 7,9"

Mondador // Paring Knife
Couteau Office // Spelucchino
Descascador



230524

 130mm / 5"
230mm / 9"

Chuletero // Steak Knife
Couteau Steak // Coltello Bistecca
Para Costoletas



230624

 150mm / 6"
271mm / 10,6"

Cocina // Kitchen Knife
Couteau à Découper // Coltello
Cucina // Cozinha



232824

 145mm / 6"
292mm / 11,4"



Queso // Cheese Knife
Couteau Fromage // Coltello
Formaggio // Queijo



233324

 180mm / 7"
320mm / 12,5"

Tenedor Trinchante // Carving Fork
Fourchette Diapason
Forchettone // Garfo Trinchante

	Estuche	Case	Étui	Astuccio	Estojo
	Acero Inoxidable forjado NITRUM® Polioximetileno (POM)	NITRUM® Forged Stainless Steel Polyoxymethylene (POM)	Acier Inoxydable Forgé NITRUM® Polyoxyméthylène (POM)	Acciaio Inossidabile Forgiato NITRUM® Polioximetilene (POM)	Aço Inoxidável Forjado NITRUM® Polioximetileno (POM)



233224



140mm / 5"
268mm / 10,5"

Santoku (Con Alveolos)
Santoku Knife (Granton Edge)
C. Santoku (Alvéolé) // Coltello
Santoku (Con Alveole) // Santoku
(com Alveolos)



233524



180mm / 7"
309mm / 12,1"

Santoku (Con Alveolos)
Santoku Knife (Granton Edge)
C. Santoku (Alvéolé) // Coltello
Santoku (Con Alveole) // Santoku
(com Alveolos)



233124



180mm / 7"
321mm / 12,6"

Rocking Santoku (Con Alveolos)
Rocking Santoku Knife (Granton
Edge) // C. Rocking Santoku
(Alvéolé) // Coltello Rocking
Santoku (con Alveole) // Rocking
Santoku (com Alveolos)



233424

150mm / 6"
272mm / 10,7"

Cocinero // Chef's Knife
Couteau Chef // Coltello Cucina
Cozinheiro



233624

200mm / 8"
327mm / 12,8"



Cocinero // Chef's Knife
Couteau Chef // Coltello Cucina
Cozinheiro



233724

250mm / 10"
378mm / 14,8"

Cocinero // Chef's Knife
Couteau Chef // Coltello Cucina
Cozinheiro

	Estuche	Case	Étui	Astuccio	Estojo
	Acero Inoxidable forjado NITRUM® Polioximetileno (POM)	NITRUM® Forged Stainless Steel Polyoxymethylene (POM)	Acier Inoxydable Forgé NITRUM® Polyoxyméthylène (POM)	Acciaio Inossidabile Forgiato NITRUM® Polioximetilene (POM)	Aço Inoxidável Forjado NITRUM® Polioximetileno (POM)



231524

 130mm / 5"
251mm / 9,8"

Deshuesador // Boning Knife
C. À Désosser // Coltello Disosso
Para Desossar



232024

 130mm / 5"
232mm / 9,1"

Tomatero (Sierra) // Tomato Knife
(Serrated) // Couteau Citron-
Tomates (Cranté) // Coltello
Pomodoro (Seghettato) // Para
Tomate (Perolado)



231324

 200mm / 8"
323mm / 12,7"

Panero (Sierra) // Bread Knife
(Serrated) // Couteau Pain (Cranté)
Coltello Pane (Seghettato) // Para
Pão (Perolado)



231024

 250mm / 10"
374mm / 14,7"



Jamonero (Flexible-Con Alveolos)
Slicing Knife (Flexible-Granton
Edge) // C. Jambon (Flexible-
Alvéolé) // Coltello Prosciutto
(Flessibile-Con Alveole)
Para Presunto (Flexível com
Alveolos)



231124

 300mm / 11"
418mm / 16,4"

Jamonero (Flexible) // Slicing Knife
(Flexible) // C. Jambon (Flexible)
Coltello Prosciutto (Flessibile)
Para Presunto (Flexível)

	Estuche	Case	Étui	Astuccio	Estojo
	Acero Inoxidable forjado NITRUM® Polioximetileno (POM)	NITRUM® Forged Stainless Steel Polyoxymethylene (POM)	Acier Inoxydable Forgé NITRUM® Polyoxyméthylène (POM)	Acciaio Inossidabile Forgiato NITRUM® Polioximetilene (POM)	Aço Inoxidável Forjado NITRUM® Polioximetileno (POM)





2302

2334

2336

**838410**Set 3 piezas // 3 pc. Set // Set 3 Pièces
Ceppo 3 Pezzi // Set 3 Peças

	Caja Regalo	Gift Box	Boîte Cadeau	Scatola Regalo	Caixa de Presente
	Acero Inoxidable forjado NITRUM® Polioximetileno (POM)	NITRUM® Forged Stainless Steel Polyoxymethylene (POM)	Acier Inoxydable Forgé NITRUM® Polyoxyméthylène (POM)	Acciaio Inossidabile Forgiato NITRUM® Polioximetilene (POM)	Aço Inoxidável Forjado NITRUM® Polioximetileno (POM)
	Madera de Caucho (235024) Madera de Haya (234524)	Rubber Wood (235024) BeechWood (234524)	Bois de Caoutchouc (235024) Bois de Hêtre (234524)	Legno di Caucciù (235024) Legno di Faggio (234524)	Madeira de Borracha (235024) Madeira de Faia (234524)

235024Juego 5 piezas // 5 pc. Set // Bloc 5 Pièces
Ceppo 5 Pezzi // Conjunto 5 Peças**234524**Juego 5 piezas // 5 pc. Set // Bloc 5 Pièces
Ceppo 5 Pezzi // Conjunto 5 Peças

7849

2302

2334

2336

2313



1853

2302

2334

2336

2313



SERIE CLARA

Cada cuchillo Clara es un homenaje a los cocineros apasionados, uniendo hojas de precisión con mangos más sencillos y ergonómicos para una cocina intuitiva y accesible a todos.

Each Clara knife pays tribute to avid cooks, uniting precision blades with the simplest and most ergonomic handles for intuitive cooking, which are accessible to all.

Chaque couteau Clara est un hommage aux cuisiniers passionnés, mariant des lames de précision à des manches plus simples et plus ergonomiques pour une cuisine intuitive et accessible à tous.

Ogni coltello Clara è un tributo ai cuochi appassionati, giacché unisce delle lame di precisione a manici più semplici ed ergonomici, per una cucina intuitiva e accessibile a tutti.

Cada faca Clara é um tributo aos cozinheiros apaixonados, combinando lâminas de precisão com cabos mais simples e ergonómicos para uma cozinha intuitiva e acessível a todos.

EXCLUSIVE NITRUM®
STAINLESS STEEL

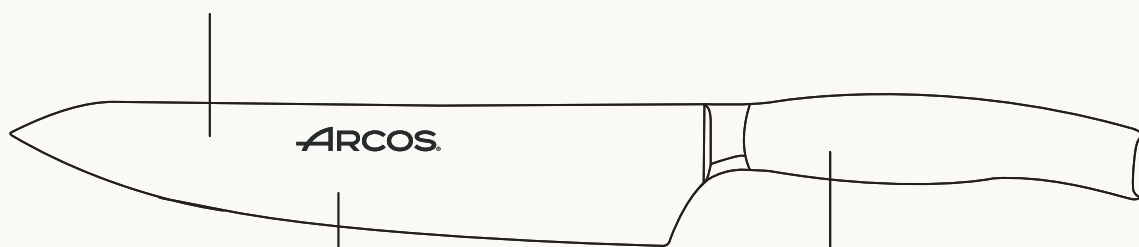

FORGED



POLIPROPILENO (PP)



Forjado

Forged · Forgé · Forgiato · Forjado.

Acero Inoxidable Forjado NITRUM®



NITRUM® Forged Stainless Steel · Acier Inoxydable Forgé
NITRUM® · Acciaio Inossidabile Forgiato NITRUM® Aço
Inoxidável Forjado NITRUM®.

Inyección

Inyección · Injection · Injeção · Iniezione · Inveccção .

Plásticos Técnicos (PP)

Technical Plastics (PP) · Plastiques Techniques (PP)
Plastiche Tecniche (PP) · Plásticos Técnicos (PP) .

	Estuche	Case	Étui	Astuccio	Estojo
	Acero Inoxidable forjado NITRUM® Polipropileno (PP)	NITRUM® Forged Stainless Steel Polypropylene (PP)	Acier Inoxydable Forgé NITRUM® Polypropylène (PP)	Acciaio Inossidabile Forgiato NITRUM® Polipropileno (PP)	Aço Inoxidável Forjado NITRUM® Polipropileno (PP)



210100

 100mm / 4"
212mm / 8,3"

Mondador // Paring Knife
Couteau Office // Spelucchino
Descascador



211100

 130mm / 5"
240mm / 9,4"

Verduras // Vegetable Knife
Couteau Légumes // Coltello
Verdura // Legumes



210400

 150mm / 6"
278mm / 10,9"

Cocinero // Chef's Knife
Couteau Chef // Coltello Cucina
Cozinheiro



210600

 200mm / 8"
341mm / 13,4"

Cocinero // Chef's Knife
Couteau Chef // Coltello Cucina
Cozinheiro



210700

 200mm / 8"
326mm / 12,8"



Panero (Sierra) // Bread Knife
(Serrated) // Couteau Pain (Cranté)
Coltello Pane (Seghettato) // Para
Pão (Perolado)



211900

 250mm / 10"
377mm / 14,8"

Jamonero (Flexible) // Slicing Knife
(Flexible) // C. Jambon (Flexible)
Coltello Prosciutto (Flessibile)
Para Presunto (Flexível)

	Estuche	Case	Étui	Astuccio	Estojo
	Acero Inoxidable forjado NITRUM® Polipropileno (PP)	NITRUM® Forged Stainless Steel Polypropylene (PP)	Acier Inoxydable Forgé NITRUM® Polypropylène (PP)	Acciaio Inossidabile Forgiato NITRUM® Polipropilene (PP)	Aço Inoxidável Forjado NITRUM® Polipropileno (PP)





2101

2104

2106

**212000**

Set 3 piezas // 3 pc. Set // Set 3 Ctx.
Set 3 Pezzi // Conjunto 3 Peças

	Caja Regalo	Gift Box	Boîte Cadeau	Scatola Regalo	Caixa de Presente
	Acero Inoxidable forjado NITRUM® Polipropileno (PP)	NITRUM® Forged Stainless Steel Polypropylene (PP)	Acier Inoxydable Forgé NITRUM® Polypropylène (PP)	Acciaio Inossidabile Forgiato NITRUM® Polipropilene (PP)	Aço Inoxidável Forjado NITRUM® Polipropileno (PP)
	Plástico Interior de Fibras de Caucho	Plastic Rubber Fibre Interior	Plastique Intérieur - Fibras de Caoutchouc	Plastica Interno in Fibre di Gomma	Plástico Interior de Fibras de Borracha



2101

2104

2106

2107

**212100**

Juego 4 piezas // 4 Pc. Set // Bloc
4 Ctx // Ceppo 4 Pezzi // Conjunto
4 Peças



SERIE MAITRE

Diseñados para armonizar con cada movimiento, nuestros cuchillos ofrecen un agarre intuitivo y curvas amables que se complementan con tu ritmo en la cocina, asegurando precisión y durabilidad en cada corte.

Designed to harmonise each movement, our knives provide an intuitive grip and pleasant curves that complement your pace in the kitchen, ensuring precision and stability in each cut.

Conçus pour s'harmoniser avec chaque mouvement, nos couteaux offrent une prise en main intuitive et des courbes douces qui complètent votre rythme dans la cuisine, assurant précision et durabilité dans chaque coupe.

Progettati per armonizzarsi ad ogni movimento, i nostri coltelli offrono una presa intuitiva e curve dolci, che si integrano al vostro ritmo in cucina, garantendo precisione e durevolezza ad ogni taglio.

Concebidas para se harmonizarem com todos os seus movimentos, as nossas facas oferecem uma pega intuitiva e curvas suaves que complementam o seu ritmo na cozinha, garantindo precisão e durabilidade em cada corte.



Acero Inoxidable NITRUM®

NITRUM® Stainless steel · Acier Inoxydable NITRUM® · Acciaio Inossidabile NITRUM® · Aço Inoxidável NITRUM®.



Remaches de Acero Inox

Stainless Steel Rivets · Rivets en Acier Inoxydable · Rivetti in Acciaio Inossidabile · Rebites de Aço Inoxidável.



Plásticos Técnicos (PP)

Technical Plastics (Polipropileno) · Plastiques Techniques (Polypropylene) · Plastiche Tecniche (Polypropylène) · Plásticos Técnicos (Polipropilene).

	Blister Cartón	Blister Cardboard	Blister en Carton	Blister di Cartone	Blister de Cartão
	Acero Inoxidable NITRUM® Polipropileno (PP)	NITRUM® Stainless Steel Polypropylene (PP)	Acier Inoxydable NITRUM® Polypropylène (PP)	Acciaio Inossidabile NITRUM® Polipropilene (PP)	Aço Inoxidável NITRUM® Polipropileno (PP)



150200

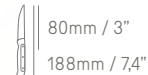

Mondador // Paring Knife
Couteau Office // Spelucchino
Descascador



150300



Mondador // Paring Knife
Couteau Office // Spelucchino
Descascador



150500



Verduras // Vegetable Knife
Couteau Légumes // Coltello
Verdura // Legumes



150700



Cocina // Kitchen Knife
Couteau à Découper // Coltello
Cucina // Cozinha



150800

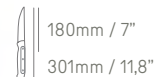



Cocina // Kitchen Knife
Couteau à Découper // Coltello
Cucina // Cozinha

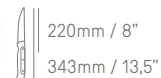

150900



Trinchante // Carving knife
Couteau Tranchelard // Coltello
Trinciante // Trinchante

	Blister Cartón	Blister Cardboard	Blister en Carton	Blister di Cartone	Blister de Cartão
	Acero Inoxidable NITRUM® Polipropileno (PP)	NITRUM® Stainless Steel Polypropylene (PP)	Acier Inoxydable NITRUM® Polypropylène (PP)	Acciaio Inossidabile NITRUM® Polipropilene (PP)	Aço Inoxidável NITRUM® Polipropileno (PP)



151500

 160mm / 6"
277mm / 10,9"

Deshuesador // Boning Knife
Couteau à Désosser // Coltello
Disosso // Para Desossar



151600

 170mm / 7"
288mm / 11,3"

Santoku (Con Alveolos)
Santoku Knife (Granton Edge)
Couteau Santoku (Alvéolé)
Coltello Santoku (Con Alveole)
Santoku (com Alveolos)



151000

 215mm / 8"
335mm / 13,1"

Cocinero // Chef's Knife
Couteau Chef // Coltello Cucina
Cozinheiro



151400

 210mm / 8"
336mm / 13,2"

Panero (Sierra) // Bread Knife
(Serrated) // Couteau Pain (Cranté)
Coltello Pane (Seghettato) // Para
Pão (Perolado)



151800

 240mm / 9,4"
360mm / 14,1"

Jamonero (Flexible) // Slicing
Knife (Flexible) // Couteau Jambon
(Flexible) // Coltello Prosciutto
(Flessibile) // Para Presunto
(Flexível)

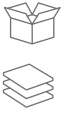
	Estuche Acero Inoxidable NITRUM® Polipropileno (PP)	Case NITRUM® Stainless Steel Polypropylene (PP)	Étui Acier Inoxydable NITRUM® Polypropylène (PP)	Astuccio Acciaio Inossidabile NITRUM® Polipropilene (PP)	Estojo Aço Inoxidável NITRUM® Polipropileno (PP)
---	---	---	--	--	--



7821

1518



151900

Juego 2 pzas. // 2 pc. Set
Ensemble 2 Pièces // Set 2 Pezzi
Conjunto 2 Peças

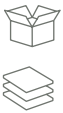
	Estuche Acero Inoxidable NITRUM® Polipropileno (PP)	Case NITRUM® Stainless Steel Polypropylene (PP)	Étui Acier Inoxydable NITRUM® Polypropylène (PP)	Astuccio Acciaio Inossidabile NITRUM® Polipropilene (PP)	Estojo Aço Inoxidável NITRUM® Polipropileno (PP)
---	---	---	--	--	--



1505

1507

1510

1856



152600

Set 4 piezas // 4 pc. Set
Set 4 Pièces // Set 4 Pezzi
Conjunto 4 Peças

	Caja Regalo	Gift Box	Boîte Cadeau	Scatola Regalo	Caixa de Presente
	Acero Inoxidable NITRUM® Polipropileno (PP)	NITRUM® Stainless Steel Polypropylene (PP)	Acier Inoxydable NITRUM® Polypropylène (PP)	Acciaio Inossidabile NITRUM® Polipropilene (PP)	Aço Inoxidável NITRUM® Polipropileno (PP)
	Madera de Pino	Pine Wood	Bois de Pin	Legno di Pino	Madeira de Pinho

152000

Juego 5 piezas // 5 pc. Set
Bloc 5 Pièces // Ceppo 5 Pezzi
Conjunto 5 Peças



1502 1507 1510 1514 2784



152100

Juego 5 piezas // 5 pc. Set
Bloc 5 Pièces // Ceppo 5 Pezzi
Conjunto 5 Peças



1856 1505 1510 1514 1518





SERIE NIZA

Sencillez y eficacia se unen en la serie Niza, ideal para el uso diario. Sus materiales de fabricación garantizan un rendimiento duradero y fiable en la rutina de cualquier cocina.

Simplicity and efficiency come together in the Niza series, ideal for daily use. The materials used to make them guarantee a reliable and long-lasting performance in the routine of any kitchen.

Simplicité et efficacité se conjuguent dans la série Niza, idéale à utiliser au quotidien. Ses matériaux de fabrication garantissent des performances durables et fiables jour après jour dans toutes les cuisines.

Semplicità ed efficienza si uniscono nella serie Niza, ideale per l'uso quotidiano. I materiali con cui è fabbricata garantiscono una resa durevole e affidabile nella routine di ogni cucina.

A simplicidade e a eficácia estão reunidas na série Niza, ideal para o uso quotidiano. Os seus materiais de fabrico garantem um desempenho duradouro e fiável em qualquer rotina de cozinha.



Acero Inoxidable NITRUM®

NITRUM® Stainless Steel · Acier Inoxydable NITRUM® · Acciaio Inossidabile NITRUM® · Aço Inoxidável NITRUM®.

Inyección

Inyección · Injection · Injection · Iniezione · Invecção .

Plástico Higiénico



Hygienic Plastic · Plastique Hygienne · Plastica Igienica
Plástico Higiénico.

Plásticos Técnicos (PP)

Technical Plastics (Polipropileno) · Plastiques Techniques (Polypropylene) · Plastiche Tecniche (Polypropylène) · Plásticos Técnicos (Polipropilene) .

Resistente Altas Temperaturas

High-Temperature Resistant · Résistant Aux Hautes Températures · Resistente Alle Alte Temperature
Resistente a Altas Temperaturas.

	Blister Cartón	Blister Cardboard	Blister en Carton	Blister di Cartone	Blister de Cartão
	Acero Inoxidable Nitrum® Polipropileno (PP)	NITRUM® Stainless Steel Polypropylene (PP)	Acier Inoxydable NITRUM® Polypropylène (PP)	Acciaio Inossidabile NITRUM® Polipropilene (PP)	Aço Inoxidável Nitrum® Polipropileno (PP)



135000

85mm / 3"
198mm / 7,7"

Mondador // Paring Knife
C. Office // Spelucchino
Descascador



135200

110mm / 4"
224mm / 8,8"

Verduras // Vegetable Knife
Couteau Légumes // Coltello
Verdura // Legumes



135300

150mm / 6"
284mm / 11,1"

Cocina // Kitchen Knife
Couteau à Découper // Coltello
Cucina Cozinha



135400

200mm / 8"
330mm / 12,9"



Cocina // Kitchen Knife
Couteau à Découper // Coltello
Cucina Cozinha



135800

200mm / 8"
332mm / 13"

Cocinero // Chef's Knife
Couteau Chef // Coltello Cucina
Cozinheiro

	Blister Cartón	Blister Cardboard	Blister en Carton	Blister di Cartone	Blister de Cartão
	Acero Inoxidable NITRUM® Polipropileno (PP)	NITRUM® Stainless Steel Polypropylene (PP)	Acier Inoxydable NITRUM® Polypropylène (PP)	Acciaio Inossidabile NITRUM® Polipropilene (PP)	Aço Inoxidável NITRUM® Polipropileno (PP)



135500



 180mm / 7"
 314mm / 12,3"

Santoku (Con Alveolos)
Santoku Knife (Granton Edge)
C. Santoku (Alvéolé) // Coltello
Santoku (Con Alveole) // Santoku
(com Alveolos)





135700

 200mm / 8"
 330mm / 12,9"



Panero (Sierra) // Bread Knife
(Serrated) // Couteau Pain (Cranté)
Coltello Pane (Seghettato) // Para
Pão (Perolado)



135600

 240mm / 9"
 380mm / 14,9"

Jamonero (Flexible) // Slicing Knife
(Flexible) // C. Jambon (Flexible)
Coltello Prosciutto (Flessibile)
Para Presunto (Flexível)

	Display	Display	Carte	Display	Display
	Acero Inoxidable NITRUM® Polipropileno (PP)	NITRUM® Stainless Steel Polypropylene (PP)	Acier Inoxydable NITRUM® Polypropylène (PP)	Acciaio Inossidabile NITRUM® Polipropilene (PP)	Aço Inoxidável NITRUM® Polipropileno (PP)



8218





1356



136700

Juego 2 pzas. // 2 pc. Set
Ensemble 2 Pièces // Set 2 Pezzi
Conjunto 2 Peças

	Display	Display	Carte	Display	Display
	Acero Inoxidable NITRUM® Polipropileno (PP)	NITRUM® Stainless Steel Polypropylene (PP)	Acier Inoxydable NITRUM® Polypropylène (PP)	Acciaio Inossidabile NITRUM® Polipropilene (PP)	Aço Inoxidável NITRUM® Polipropileno (PP)



134900

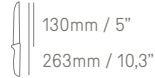

Multusos (Dentado)
Multi-Purpose Knife (Serrated)
Couteau Multi-Usages (Microdenté)
Coltello Multiuso (Dentato)
Faca Multiuso Curva (Serrilhada)





136500

Set 6 Piezas // 6 pc. Set
Set 6 Ctx. // Set 6 Pezzi
Conjunto 6 Peças



6 X 1352

	Caja Regalo	Gift Box	Boîte Cadeau	Scatola Regalo	Caixa de Presente
	Acero Inoxidable NITRUM® Polipropileno (PP)	NITRUM® Stainless Steel Polypropylene (PP)	Acier Inoxydable NITRUM® Polypropylène (PP)	Acciaio Inossidabile NITRUM® Polipropilene (PP)	Aço Inoxidável NITRUM® Polipropileno (PP)
	Madera de Caucho	Rubber Wood	Bois de Caoutchouc	Legno di Caucciù	Madeira de Borracha



136100

Juego 6 piezas // 6 pc. Set
Bloc 6 Pièces // Ceppo 6 Pezzi
Conjunto 6 Peças



SERIE LÍNEA

¡Potencia la precisión en cada corte! Con su diseño innovador y filo micro dentado lograrás cortes precisos y perfectos en todo tipo de alimentos desde carnes, pescados y pan hasta frutas y verduras.

Enhance the precision in each cut! With its innovative design and micro-serrated edge you will get perfectly precise cuts in all types of food from meat, fish, bread to fruit and vegetables.

Renforcez votre précision à chaque découpe ! Avec son design innovant et son tranchant microdenté, vous obtiendrez des coupes précises et parfaites avec tous types d'aliments, que ce soit de la viande, du poisson, du pain, des fruits ou des légumes.

Potenzia la precisione ad ogni taglio! Grazie al suo design innovatore e al filo micro-dentato otterrete tagli precisi e perfetti per ogni tipo di alimento, dalle carni, al pesce, al pane e persino a frutta e verdura.

Potencie a precisão em cada corte! Com o seu design inovador e o seu fio micro serrilhado, conseguirá cortes precisos e perfeitos em todos os tipos de alimentos, desde carne, peixe e pão a frutas e legumes.



Acero Inoxidable NITRUM®

NITRUM® Stainless steel · Acier Inoxydable NITRUM® · Acciaio Inossidabile NITRUM® · Aço Inoxidável NITRUM®.

Siempre Afilado

Forever Sharp · Toujours Tranchant · Sempre Affilato
Sempre Afiado.



Dentado

Serrated · Microdenté · Dentato · Serrilhada.

Brillo Espejo

Mirror Finish · Finition Miroir · Lucentezza Specchio · Brilho Espelho.





Doble Inyección

Double Injection · Double Injection · Doppia Iniezione
Injeção Dupla.



Plásticos Técnicos (PP)

Technical Plastics (Polipropileno) · Plastiques Techniques (Polypropylene) · Plastiche Tecniche (Polypropylène) · Plásticos Técnicos (Polipropilene).

 	379301 Caja 379300 Blister Cartón	379301 Box 379300 Blister Cardboard	379301 Boîte 379300 Blister en Carton	379301 Scatola 379300 Blister di Cartone	379301 Caixa 379300 Blister de Cartão
	Acero Inoxidable NITRUM® Polipropileno (PP)	NITRUM® Stainless Steel Polypropylene (PP)	Acier Inoxydable NITRUM® Polypropylène (PP)	Acciaio Inossidabile NITRUM® Polipropilene (PP)	Aço Inoxidável NITRUM® Polipropileno (PP)



379300/379301

110mm / 4"
228mm / 8,9"

Mondador (Dentado)
Paring Knife (Serrated)
Couteau Office (Microdenté)
Spelucchino (Dentato)
Descascador (Serrilhada)



379400

160mm / 6,3"
299mm / 11,7"



Cocina (Dentado)
Kitchen Knife (Serrated)
Couteau Multiusage (Microdenté)
Coltello Cucina (Dentato)
Cozinha (Serrilhada)



379500

180mm / 7"
320mm / 12,6"

Cocina (Dentado)
Kitchen Knife (Serrated)
Couteau Multiusage (Microdenté)
Coltello Cucina (Dentato)
Cozinha (Serrilhada)



	Caja Expositora	Display Box	Boîte Présentoir	Scatola Expo	Caixa expositora
	Acero Inoxidable NITRUM® Polipropileno (PP)	NITRUM® Stainless Steel Polypropylene (PP)	Acier Inoxydable NITRUM® Polypropylène (PP)	Acciaio Inossidabile NITRUM® Polipropilene (PP)	Aço Inoxidável NITRUM® Polipropileno (PP)



373624

100mm / 3,9"
215mm / 8,4"

Cuchillo Outdoor (Dentado)
Outdoor Knife (Serrated)
Couteau Outdoor (Microdenté)
Coltello Outdoor (Dentato)
Faca Outdoor (Serrilhada)



	Caja	Box	Boîte	Scatola	Caixa
	Acero Inoxidable NITRUM® Polipropileno (PP)	NITRUM® Stainless Steel Polypropylene (PP)	Acier Inoxydable NITRUM® Polypropylène (PP)	Acciaio Inossidabile NITRUM® Polipropilene (PP)	Aço Inoxidável NITRUM® Polipropileno (PP)



373424

150mm / 5,9"
265mm / 10,4"

Cuchillo Mesa (Dentado)
Table Knife (Serrated)
Couteau Table (Microdenté)
Coltello Tavola (Dentato)
Faca Mesa (Serrilhada)



	Caja	Box	Boîte	Scatola	Caixa
	Acero Inoxidable NITRUM® Polipropileno (PP)	NITRUM® Stainless Steel Polypropylene (PP)	Acier Inoxydable NITRUM® Polypropylène (PP)	Acciaio Inossidabile NITRUM® Polipropilene (PP)	Aço Inoxidável NITRUM® Polipropileno (PP)

849300

Set 2 Piezas // 2 pc. Set
Set 2 Ctx. // Set 2 Pezzi
Conjunto 2 Peças



2X 373624

	Caja Expositora	Display Box	Boîte Présentoir	Scatola S.Expo	Caixa Expositora
	Acero Inoxidable Nitrum® Polipropileno (PP)	NITRUM® Stainless Steel Polypropylene (PP)	Acier Inoxydable NITRUM® Polypropylène (PP)	Acciaio Inossidabile NITRUM® Polipropilene (PP)	Aço Inoxidável NITRUM® Polipropileno (PP)



NEW

3736352

100mm / 3,9"
215mm / 8,4"

Cuchillo Outdoor (Dentado) Rojo
Outdoor Knife (Serrated) Red
Couteau Outdoor (Microdenté)
Rouge // Coltello Outdoor
(Dentato) Rosso // Faca Outdoor
(Serrilhada) Vermelho



NEW

373656

100mm / 3,9"
215mm / 8,4"

Cuchillo Outdoor (Dentado) Naranja
Outdoor Knife (Serrated) Orange
Couteau Outdoor (Microdenté) Orange // Coltello Outdoor (Dentato) Arancione // Faca Outdoor (Serrilhada) Laranja





NEW

373651

100mm / 3,9"
215mm / 8,4"

Cuchillo Outdoor (Dentado) Verde
Outdoor Knife (Serrated) Green
Couteau Outdoor (Microdenté) Vert
Coltello Outdoor (Dentato) Verde
Faca Outdoor (Serrilhada) Verde

	Estuche	Case	Étui	Astuccio	Estojo
	Acero Inoxidable NITRUM® Polipropileno (PP)	NITRUM® Stainless Steel Polypropylene (PP)	Acier Inoxydable NITRUM® Polypropylène (PP)	Acciaio Inossidabile NITRUM® Polipropilene (PP)	Aço Inoxidável NITRUM® Polipropileno (PP)



1X 373656

1X 373652

1X 373651



NEW

849000

Set 3 Piezas // 3 pc. Set
Set 3 Ctx. // Set 3 Pezzi
Conjunto 3 Peças



SERIE LATINA

Realza la cotidianidad con mangos de madera que evocan tradición, ofreciendo sencillez y una elegancia atemporal, ideal para el día a día del cocinero apasionado por lo auténtico.

Everyday life is enhanced with the wooden handles that evoke tradition, providing simplicity and a classic elegance, ideal for daily use for cooks who are passionate about authenticity.

Sublimez le quotidien avec des manches en bois qui évoquent la tradition, offrant simplicité et élégance intemporelle, idéale pour le quotidien des cuisiniers passionnés d'authenticité.

Risalta la consuetudine grazie a manici di legno che richiamano la tradizione ed offrono semplicità e un'eleganza atemporale, ideale per la vita quotidiana del cuoco appassionato dell'autenticità.

Valoriza o quotidiano com cabos de madeira que evocam a tradição, oferecendo simplicidade e elegância intemporal, ideal para o cozinheiro quotidiano com uma paixão pela autenticidade.



Acero Inoxidable NITRUM®

NITRUM® Stainless Steel · Acier Inoxydable NITRUM® · Acciaio Inossidabile NITRUM® · Aço Inoxidável NITRUM®.



Remaches de Acero Inox

Stainless Steel Rivets · Rivets en Acier Inoxydable · Rivetti in Acciaio Inossidabile · Rebites de Aço Inoxidável.





Madera Comprimida

Pack Wood · Bois Compressé · Legno Compresso · Madeira Comprimida.

Diseño Clásico

Classic Design · Design Classique · Design Classico
Design Clássico.

 	100100, 102700, 102500, 100400, 100500 Caja	100100, 102700, 102500, 100400, 100500 Box	100100, 102700, 102500, 100400, 100500 Boîte	100100, 102700, 102500, 100400, 100500 Scatola	100100, 102700, 102500, 100400, 100500 Caixa
	100101, 102701, 102501, 100401, 100501 Blister	100101, 102701, 102501, 100401, 100501 Blister	100101, 102701, 102501, 100401, 100501 Blister	100101, 102701, 102501, 100401, 100501 Blister	100101, 102701, 102501, 100401, 100501 Blister
	Acero Inoxidable NITRUM® Madera Comprimida	NITRUM® Stainless Steel Pack Wood	Acier Inoxydable NITRUM® Bois Compressé	Acciaio Inossidabile NITRUM® Legno Compresso	Aço Inoxidável NITRUM® Madeira Comprimida



100100/100101

65mm / 2"
160mm / 6,2"

Mondador // Paring Knife
Couteau Office // Spelucchino
Descascador



102700/102701

90mm / 3"
182mm / 7,1"

Mantequilla (Dentado) // Butter
Knife (Serrated) // Couteau Beurre
(Microdenté) // Coltello Burro
(Dentato) Manteiga (Serrilhada)



102500/102501

105mm / 4"
200mm / 7,8"

Cuchillo Queso (Microdentado)
Cheese Knife (Micro-Serrated)
Couteau Fromage (Microcranté)
Coltello Formaggio (Microdentato)
Queijo (Micro-Serrilhada)



100400/100401

105mm / 4"
198mm / 7,7"



Chuletero (Microdentado) // Steak
Knife (Micro-Serrated) // Couteaut
Steak (Microcranté) // Coltello
Bistecca (Microdentato) // Para
Costoletas (Micro-Serrilhada)



100500/100501

105mm / 4"
198mm / 7,7"

Verduras // Vegetable Knife
Couteau Légumes // Coltello
Verdura // Legumes

 	100800, 100600, 100700, 101500, 101300 Caja 100801, 100601, 100701, 101501, 101301 Blister Acero Inoxidable NITRUM® Madera Comprimida	100800, 100600, 100700, 101500, 101300 Box 100801, 100601, 100701, 101501, 101301 Blister NITRUM® Stainless Steel Pack Wood	100800, 100600, 100700, 101500, 101300 Boîte 100801, 100601, 100701, 101501, 101301 Blister Acier Inoxydable NITRUM® Bois Compressé	100800, 100600, 100700, 101500, 101300 Scatola 100801, 100601, 100701, 101501, 101301 Blister Acciaio Inossidabile NITRUM® Legno Compresso	100800, 100600, 100700, 101500, 101300 Caixa 100801, 100601, 100701, 101501, 101301 Blister Aço Inoxidável NITRUM® Madeira Comprimida
--	--	--	--	---	--



100800/100801



Cocina (Microdentado) // Kitchen Knife (Micro-Serrated) // Couteau à Découper (Microcranté) // Coltello Cucina (Microdentato) // Cozinha (Micro-Serrilhada)



100600/100601



Cocina // Kitchen Knife
C. A Découper // Coltello Cucina
Cozinha



100700/100701

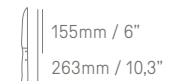

Cocina // Kitchen Knife
C. A Découper // Coltello Cucina
Cozinha



101500/101501



Panero (Dentado) // Bread Knife (Serrated) // Couteau Pain (Microdenté) // Coltello Pane (Dentato) // Para Pão (Serrilhada)



101300/101301

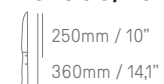

Jamonero (Flexible) // Slicing Knife (Flexible) // C. Jambon (Flexible) // Coltello Prosciutto (Flessibile) // Para Presunto (Flexível)



SERIE NOVA

Un soplo de frescura y color en tu cocina. Cuchillos ligeros y funcionales. Su corte fino y preciso los hace ideales para pequeñas frutas y verduras, disponibles en una paleta de hasta diez colores distintos.

A breath of fresh air and colour in your kitchen. Light and practical knives. Their fine and precise cuts make them ideal for small fruit and vegetables, available in a palette of up to ten different colours.

Un souffle de fraîcheur et de couleur dans votre cuisine. Des couteaux légers et fonctionnels. Leur coupe fine et précise les rend parfaits pour les petits fruits et légumes, disponibles dans une palette qui regroupe jusqu'à dix couleurs différentes.

Una sferzata di freschezza e colore nella vostra cucina. Coltelli leggeri e funzionali. Il loro taglio fine e preciso li rende ideali per piccoli frutti e verdure, disponibili in una gamma di ben dieci colori diversi.

Um sopro de frescura e cor na sua cozinha. Facas leves e funcionais. O seu corte fino e preciso torna-as ideais para pequenas frutas e legumes, disponíveis numa paleta de até dez cores diferentes.



Acero Inoxidable NITRUM®

NITRUM® Stainless steel · Acier Inoxydable NITRUM® · Acciaio Inossidabile NITRUM® · Aço Inoxidável NITRUM®.



Inyección

Inyección · Injection · Injeção · Iniezione · Inveçção.

Mangos de Colores

Handles of Colors · Manches de Couleurs · Manici Colorati · Cabos de Cores.



Plásticos Técnicos (PP)

Technical Plastics (Polipropileno) · Plastiques Techniques (Polypropylene) · Plastiche Tecniche (Polypropylène) · Plásticos Técnicos (Polipropilene).



Resistente Altas Temperaturas

High-Temperature Resistant · Résistant aux Hautes Températures · Resistente alle Alte Temperature · Resistência a Altas Temperaturas.

 	Caja Expositora 188301, 18840, 188501, 188601 Blister	Display Box 188301, 18840, 188501, 188601 Blister	Boîte Présentoir 188301, 18840, 188501, 188601 Blister	Scatola Expo 188301, 18840, 188501, 188601 Blister	Caixa Expositora 188301, 18840, 188501, 188601 Blister
	Acero Inoxidable NITRUM® Polipropileno (PP)	NITRUM® Stainless Steel Polypropylene (PP)	Acier Inoxydable NITRUM® Polypropylène (PP)	Acciaio Inossidabile NITRUM® Polipropilene (PP)	Aço Inoxidável NITRUM® Polipropileno (PP)



188300/188301

60mm / 2"
172mm / 6,7"

Mondador // Paring Knife
C. Office // Spelucchino
Descascador



188400/188401

80mm / 3"
190mm / 7,4"

Mondador // Paring Knife
Couteau Office // Spelucchino
Descascador

● 188421 ● 188422



188500/ 188501

85mm / 3"
200mm / 7,8"

Mondador // Paring Knife
Couteau Office // Spelucchino
Descascador

● 188521 ● 188522 ● 188523 ○ 188524 ● 188525 ● 188528 ● 188576 ● 188577 ● 188578



188510

85mm / 3"
200mm / 7,8"

Mondador (Dentado)
Paring Knife (Serrated)Couteau
Office (Microdenté)Couteau
Spelucchino (Dentato)
Descascador (Serrilhada)



188600/188601

100mm / 4"
211mm / 8,3"

Mondador // Paring Knife
Couteau Office // Spelucchino
Descascador

● 188621 ● 188622 ● 188623 ○ 188624 ● 188625 ● 188628 ● 188631 ● 188632 ● 188633 ● 188634
● 188676 ● 188677 ● 188678





188610

100mm / 4"
211mm / 8,3"

Mondador (Dentado)
Paring Knife (Serrated)
Couteau Office (Microdenté)
Spelucchino (Dentato)
Descascador (Serrilhada)

● 188611 ● 188612 ● 188613 ○ 188614 ● 188615 ● 188618

	Caja	Box	Boîte	Scatola	Caixa
	Acero Inoxidable NITRUM® Polipropileno (PP)	NITRUM® Stainless Steel Polypropylene (PP)	Acier Inoxydable NITRUM® Polypropylène (PP)	Acciaio Inossidabile NITRUM® Polipropilene (PP)	Aço Inoxidável NITRUM® Polipropileno (PP)



188200

70mm / 3"
182mm / 7,1"

Mondador // Paring Knife
Couteau Office // Spelucchino
Descascador



188700

100mm / 4"
215mm / 8,4"

Queso (Dentado) // Cheese Knife
(Serrated) // Couteau Fromage
(Microdenté) // Coltello Formaggio
(Dentato) // Queijo (Serrilhada)



188000

90mm / 3"
200mm / 7,8"

Mantequilla (Dentado) // Butter
Knife (Serrated) // Couteau Beurre
(Microdenté) // Coltello Burro
(Dentato) Manteiga (Serrilhada)



188100

115mm / 4,5"
230mm / 9"

Chuletero (Microdentado) // Steak
Knife (Micro-Serrated) // Couteau
Steak (Microcranté) // Coltello
Bistecca (Microdentato) // Para
Costoletas (Micro-Serrilhada)





188800

110mm / 4"
220mm / 8,6"

Cuchillo Mesa (Dentado) // Table
Knife (Serrated) // Couteau Table
(Microdenté) // Coltello Tavola
(Dentato) // Faca Mesa (Serrilhada)

● 188821 ● 188822 ● 188823 ○ 188824 ● 188825

 	<p>Blister</p> <p>Acero Inoxidable NITRUM® Polipropileno (PP)</p>	<p>Blister</p> <p>NITRUM® Stainless Steel Polypropylene (PP)</p>	<p>Blister</p> <p>Acier Inoxydable NITRUM® Polypropylène (PP)</p>	<p>Blister</p> <p>Acciaio Inossidabile NITRUM® Polipropilene (PP)</p>	<p>Blister</p> <p>Aço Inoxidável NITRUM® Polipropileno (PP)</p>
--	---	--	---	---	---

188900

Set 6 piezas // 6 pc. Set
Set 6 pièces // Set 6 Pezzi
Conjunto 6 Peças



6 X 188800



6 X 188100

806100

Set 6 piezas // 6 pc. Set
Set 6 pièces // Set 6 Pezzi
Conjunto 6 Peças





188576 188577 188578



859800

Set 3 piezas // 3 pc. Set
Set 3 pièces // Set 3 Pezzi
Conjunto 3 Peças

 	<p>Caja</p> <p>Acero Inoxidable NITRUM® Polipropileno (PP)</p>	<p>Box</p> <p>NITRUM® Stainless Steel Polypropylene (PP)</p>	<p>Boîte</p> <p>Acier Inoxydable NITRUM® Polypropylène (PP)</p>	<p>Scatola</p> <p>Acciaio Inossidabile NITRUM® Polipropilene (PP)</p>	<p>Caixa</p> <p>Aço Inoxidável NITRUM® Polipropileno (PP)</p>
--	--	--	---	---	---





12 X 188576 12 X 188577 12 X 188578



806200

Set 36 piezas // 36 pc. Set
Set 36 pièces // Set 36 Pezzi
Conjunto 36 Peças

 	Blister Acero Inoxidable NITRUM® Polipropileno (PP)	Blister NITRUM® Stainless Steel Polypropylene (PP)	Blister Acier Inoxydable NITRUM® Polypropylène (PP)	Blister Acciaio Inossidabile NITRUM® Polipropilene (PP)	Blister Aço Inoxidável NITRUM® Polipropileno (PP)
--	---	--	---	---	---



188300 188400



189000

Set 2 Pzas. // 2 Pc Set // Set 2 Ctx.
Set 2 Pezzi // Conjunto 2 Peças



6 X 188600



189100

Set 6 Pzas. // 6 Pc Set // Set 6 Ctx.
Set 6 Pezzi // Conjunto 6 Peças





188321 188621 188322 188622



189421 189422

189421/189422

Set 2 Pzas. // 2 Pc Set // Set 2 Ctx.
Set 2 Pezzi // Conjunto 2 Peças

 	Blister Acero Inoxidable NITRUM® Polipropileno (PP)	Blister NITRUM® Stainless Steel Polypropylene (PP)	Blister Acier Inoxydable NITRUM® Polypropylène (PP)	Blister Acciaio Inossidabile NITRUM® Polipropilene (PP)	Blister Aço Inoxidável NITRUM® Polipropileno (PP)
--	---	--	---	---	---



188300 188600 188610



189500

Set 3 piezas // 3 Pc Set // Set 3 Ctx.
Set 3 Pezzi // Conjunto 3 Peças



188321 188621 188611 188322 188622 188612



189621



189622

189621/189622

Set 3 piezas // 3 Pc Set // Set 3 Ctx.
Set 3 Pezzi // Conjunto 3 Peças





181300 188500 188610



189700

Set 3 piezas // 3 Pc Set // Set 3
Pièces // Set 3 Pezzi // Conjunto
3 Peças

	Blister Cartón	Blister Cardboard	Blister en Carton	Blister di Cartone	Blister de Cartão
	Acero Inoxidable NITRUM® Polipropileno (PP)	NITRUM® Stainless Steel Polypropylene (PP)	Acier Inoxydable NITRUM® Polypropylène (PP)	Acciaio Inossidabile NITRUM® Polipropilene (PP)	Aço Inoxidável NITRUM® Polipropileno (PP)



2 X 188500



189800

Set 2 piezas // 2 Pc Set // Set 2 Ctx.
Set 2 Pezzi // Conjunto 2 Peças



2 X 188800



189900

Set 2 piezas // 2 Pc Set // Set 2 Ctx.
Set 2 Pezzi // Conjunto 2 Peças





2 X 188600



187000

Set 2 piezas // 2 Pc Set // Set 2 Ctx.
Set 2 Pezzi // Conjunto 2 Peças

	Blister Cartón	Blister Cardboard	Blister en Carton	Blister di Cartone	Blister de Cartão
	Acero Inoxidable NITRUM® Polipropileno (PP)	NITRUM® Stainless Steel Polypropylene (PP)	Acier Inoxydable NITRUM® Polypropylène (PP)	Acciaio Inossidabile NITRUM® Polipropilene (PP)	Aço Inoxidável NITRUM® Polipropileno (PP)



188500



188510



187100

Set 2 piezas // 2 Pc Set // Set 2 Ctx.
Set 2 Pezzi // Conjunto 2 Peças



188600



188610



187200

Set 2 piezas // 2 Pc Set // Set 2 Ctx.
Set 2 Pezzi // Conjunto 2 Peças



SERIE UNIVERSAL PRO

Esencial en la cocina profesional, su diseño ergonómico y la resistencia del acero inoxidable NITRUM® se unen para enfrentar el ritmo intenso y las exigencias del entorno más profesional.

Essential in the professional kitchen, its ergonomic design and the strength of the NITRUM® stainless steel are united to face the intense pace and the demands of the more professional environment.

Indispensable dans la cuisine professionnelle, son design ergonomique et la résistance de l'acier inoxydable NITRUM® se marient pour répondre au rythme intense et aux exigences de l'environnement le plus professionnel.

Indispensabile nella cucina professionale, il suo design ergonomico e la resistenza dell'acciaio inossidabile NITRUM® si uniscono per affrontare il ritmo intenso e le esigenze dell'ambiente più professionale.

Essencial na cozinha profissional, o seu design ergonómico e a resistência do aço inoxidável NITRUM® conjugam-se para enfrentar o ritmo intenso e as exigências do ambiente mais profissional.



Acero Inoxidable NITRUM®

NITRUM® Stainless Steel · Acier Inoxydable NITRUM®
Acciaio Inossidabile NITRUM® · Aço Inoxidável NITRUM®.



Bactiproof Silver®



Remaches de Acero Inox

Stainless Steel Rivets · Rivets en Acier Inoxydable
Rivetti in Acciaio Inossidabile · Rebites de Aço Inoxidável.



Plásticos Técnicos (POM)

Technical Plastics (POM) · Plastiques
Techniques (POM) · Plastiche Tecniche (POM)
Plásticos Técnicos (POM).



Resistente Altas Temperaturas

High-Temperature Resistant · Résistant aux Hautes
Températures · Resistente alle Alte Temperature
Resistência a altas temperaturas.



NSF National Sanitary Foundation

	Estuche Acero Inoxidable NITRUM® Polioximetileno (POM)	Case NITRUM® Stainless Steel Polyoxymethylene (POM)	Étui Acier Inoxydable NITRUM® Polyoxyméthylène (POM)	Astuccio Acciaio Inossidabile NITRUM® Polioxiometilene (POM)	Estojo Aço Inoxidável NITRUM® Polioxiometileno (POM)
---	--	---	--	--	--



280004

 60mm / 2"
160mm / 6,2"

Mondador (Curvo) // Paring Knife (Curved) // Couteau Office (Courbé) // Spelucchino (Curvato) Descascador (Curva)



280104

 75mm / 3"
178mm / 7"

Mondador // Paring Knife Couteau Office // Spelucchino Descascador



281004

 75mm / 3"
178mm / 7"

Mondador // Paring Knife Couteau Office // Spelucchino Descascador



289004

 60mm/2"
183mm/7,2"

Abre Ostras // Oyster Knife Couteau Ouvre Huitres // Apri-Ostriche // Abre Ostras



281104

 100mm / 4"
202mm / 7,9"

Verduras // Vegetable Knife Couteau Légumes // Coltello Verdura // Legumes



282504

 130mm / 5"
260mm / 10,2"

Deshuesador // Boning Knife Couteau à Désosser // Coltello Disosso // Para Desossar



282604

 160mm / 6"
288mm / 11,3"



Deshuesador // Boning Knife Couteau à Désosser // Coltello Disosso // Para Desossar



282704

 160mm / 6"
275mm / 10,8"

Fileteador (Flexible) // Fillet Knife (Flexible) // C. fillet de Sole (Flexible) // Coltello Filettare Pesce (Flessibile) // Filetar (Flexível)

	Estuche	Case	Étui	Astuccio	Estojo
	Acero Inoxidable NITRUM® Polioximetileno (POM)	NITRUM® Stainless Steel Polyoxymethylene (POM)	Acier Inoxydable NITRUM® Polyoxyméthylène (POM)	Acciaio Inossidabile NITRUM® Polioximetilene (POM)	Aço Inoxidável NITRUM® Polioximetileno (POM)



289104

 130mm / 5"
230mm / 9"

Tomatero (Sierra) // Tomato Knife (Serrated) // Couteau Citron-Tomate (Cranté) // Coltello Pomodoro (Seghettato) // Para Tomate (Perolado)



281204

 130mm / 5"
243mm / 9,5"

Cocina // Kitchen Knife
Couteau à Découper // Coltello
Cucina // Cozinha



281304

 150mm / 6"
265mm / 10,4"

Cocina // Kitchen Knife
Couteau à Découper // Coltello
Cucina // Cozinha



281404

 170mm / 7"
283mm / 11,1"

Cocina // Kitchen Knife
Couteau à Découper // Coltello
Cucina // Cozinha



284204

 170mm / 7"
290mm / 11,4"

Lenguado (Flexible) // Sole Knife (Flexible) // C. Filet de Sole (Flexible) // Coltello Sogliola (Flessibile) // Linguado (Flexível)



281504

 190mm / 7"
304mm / 11,9"

Trinchante // Carving knife
Couteau à Découper // Coltello
Trinciante // Faca de Trincar

	Estuche Acero Inoxidable NITRUM® Polioximetileno (POM)	Case NITRUM® Stainless Steel Polyoxymethylene (POM)	Étui Acier Inoxydable NITRUM® Polyoxyméthylène (POM)	Astuccio Acciaio Inossidabile NITRUM® Polioxiometilene (POM)	Estojo Aço Inoxidável NITRUM® Polioxiometileno (POM)
---	--	---	--	--	--



281704

 140mm / 5"
260mm / 10,2"

Cocinero // Chef's Knife
Couteau Chef // Coltello Cucina
Cozinheiro



284604

 150mm / 6"
270mm / 10,6"

Cocinero // Chef's Knife
Couteau Chef // Coltello Cucina
Cozinheiro

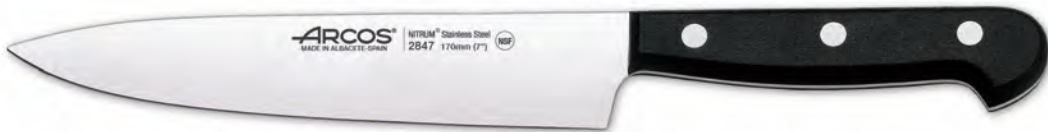

284704

 170mm / 7"
290mm / 11,4"

Cocinero // Chef's Knife
Couteau Chef // Coltello Cucina
Cozinheiro

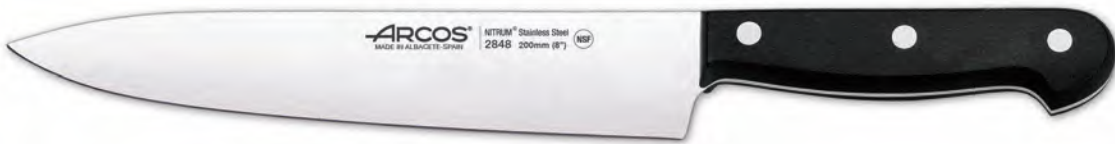

284804

 200mm / 8"
323mm / 12,7"

Cocinero // Chef's Knife
Couteau Chef // Coltello Cucina
Cozinheiro



284100

 160mm / 6"
268mm / 10,5"



Tenedor Trinchante // Carving Fork
Fourchette Diapason // Forchettone
Garfo Trinchante



281604

 145mm / 6"
277mm / 10,9"

Queso // Cheese Knife
Couteau Fromage // Coltello
Formaggio // Queijo

	Estuche	Case	Étui	Astuccio	Estojo
	Acero Inoxidable NITRUM® Polioximetileno (POM)	NITRUM® Stainless Steel Polyoxymethylene (POM)	Acier Inoxydable NITRUM® Polyoxyméthylène (POM)	Acciaio Inossidabile NITRUM® Polioximetilene (POM)	Aço Inoxidável NITRUM® Polioximetileno (POM)



280204

 100mm / 4"
205mm / 8"

Cocinero // Chef's Knife
Couteau Chef // Coltello Cucina
Cozinheiro



280304

 120mm / 5"
226mm / 8,8"

Cocinero // Chef's Knife
Couteau Chef // Coltello Cucina
Cozinheiro



280404

 155mm / 6"
270mm / 10,6"

Cocinero // Chef's Knife
Couteau Chef // Coltello Cucina
Cozinheiro



280504

 175mm / 7"
288mm / 11,3"

Cocinero // Chef's Knife
Couteau Chef // Coltello Cucina
Cozinheiro



280604

 200mm / 8"
323mm / 12,7"



Cocinero // Chef's Knife
Couteau Chef // Coltello Cucina
Cozinheiro



280601

 200mm / 8"
323mm / 12,7"

Cocinero (con Alveolos) // Chef's
Knife (Granton Edge) // C. Cuisine
(Alvéole) // Coltello Cucina
(Con Alveole) // Cozinheiro (Com
Alveolos)

	Estuche	Case	Étui	Astuccio	Estojo
	Acero Inoxidable NITRUM® Polioximetileno (POM)	NITRUM® Stainless Steel Polyoxymethylene (POM)	Acier Inoxydable NITRUM® Polyoxyméthylène (POM)	Acciaio Inossidabile NITRUM® Polioxiometilene (POM)	Aço Inoxidável NITRUM® Polioxiometileno (POM)



280704

 250mm / 10"
390mm / 15,3"

Cocinero // Chef's Knife
Couteau Chef // Coltello Cucina
Cozinheiro



280804

 300mm / 12"
440mm / 17,3"

Cocinero // Chef's Knife
Couteau Chef // Coltello Cucina
Cozinheiro



282104

 200mm / 8"
320mm / 12,5"

Panero (Sierra) // Bread Knife
(Serrated) // Couteau Pain (Cranté)
Coltello Pane (Seghettato) // Para
Pão (Perolado)



282204

 250mm / 10"
374mm / 14,7"

Panero (Sierra) // Bread Knife
(Serrated) // Couteau Pain (Cranté)
Coltello Pane (Seghettato) // Para
Pão (Perolado)



283904

 250mm / 10"
383mm / 15"



Pastelero (Sierra)
Pastry Knife (Serrated)
Couteau Genoise (Cranté)
Coltello Pasticceria-Pane
(Seghettato) // Pasteleiro
(Perolado)



284304

 300mm / 12"
424mm / 16,6"

Pastelero (Sierra)
Pastry Knife (Serrated)
Couteau Genoise (Cranté)
Coltello Pasticceria-Pane
(Seghettato) // Pasteleiro
(Perolado)

	Estuche	Case	Étui	Astuccio	Estojo
	Acero Inoxidable NITRUM® Polioximetileno (POM)	NITRUM® Stainless Steel Polyoxymethylene (POM)	Acier Inoxydable NITRUM® Polyoxyméthylène (POM)	Acciaio Inossidabile NITRUM® Polioximetileno (POM)	Aço Inoxidável NITRUM® Polioximetileno (POM)

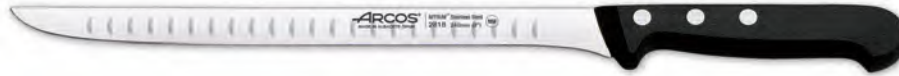

281801

 240mm / 9"
360mm / 14,1"

Jamonero (Flexible-Con Alveolos)
Slicing Knife (Flexible-Granton Edge) // C. Jambon (Flexible-Alvéolé) // Coltello Prosciutto (Flessibile-Con Alveole)
Para Presunto (Flexível com Alveolos)



281804

 240mm / 9"
360mm / 14,1"

Jamonero (Flexible) // Slicing Knife (Flexible) // C. Jambon (Flexible) // Coltello Prosciutto (Flessibile)
Para Presunto (Flexível)



281901

 280mm / 11"
402mm / 15,8"

Jamonero (Flexible-Con Alveolos)
Slicing Knife (Flexible-Granton Edge) // C. Jambon (Flexible-Alvéolé) // Coltello Prosciutto (Flessibile-Con Alveole)
Para Presunto (Flexível com Alveolos)



281904

 280mm / 11"
402mm / 15,8"

Jamonero (Flexible) // Slicing Knife (Flexible) // C. Jambon (Flexible) // Coltello Prosciutto (Flessibile)
Para Presunto (Flexível)



282004

 290mm / 11"
410mm / 16,1"



Jamonero (Flexible) // Slicing Knife (Flexible) // C. Jambon (Flexible) // Coltello Prosciutto (Flessibile)
Para Presunto (Flexível)



283804

 300mm / 12"
424mm / 16,6"

Fiambre (Ancho) // Slicing Knife (Wide) // C. Jambon (Large) // Coltello Prosciutto (Largo) // Fiambre Salmão (Largo)

	Estuche	Case	Étui	Astuccio	Estojo
	Acero Inoxidable NITRUM® Polioximetileno (POM)	NITRUM® Stainless Steel Polyoxymethylene (POM)	Acier Inoxydable NITRUM® Polyoxyméthylène (POM)	Acciaio Inossidabile NITRUM® Polioximetilene (POM)	Aço Inoxidável NITRUM® Polioximetileno (POM)



289904





 240mm / 9"
372mm / 14,6"
 3mm
 ≈ 296gr

Yanagiba // Yanagiba Knife
Couteau Yanagiba // Coltello
Yanagiba Yanagiba



286004



 170mm / 7"
293mm / 11,5"
 2mm
 ≈ 143 gr

Santoku (Con Alveolos)
Santoku Knife (Granton Edge)
Couteau Santoku (Alvéolé)
Coltello Santoku (Con Alveole)
Santoku (Com Alveolos)



288804



 170mm / 7"
301mm / 11,8"
 2mm
 ≈ 136 gr

Santoku // Santoku Knife
Couteau Santoku // Coltello
Santoku // Santoku



289804





 170mm / 7"
301mm / 11,8"
 4mm
 ≈ 257gr

Deba // Deba Knife // Couteau
Deba // Coltello Deba // Deba





289704



 175mm / 7"
307mm / 12"
 3mm
 ≈ 218gr

Usuba // Usuba Knife // Couteau
Usuba // Coltello Usuba // Usuba

	Estuche	Case	Étui	Astuccio	Estojo
	Acero Inoxidable NITRUM® Polioximetileno (POM)	NITRUM® Stainless Steel Polyoxymethylene (POM)	Acier Inoxydable NITRUM® Polyoxyméthylène (POM)	Acciaio Inossidabile NITRUM® Polioximetileno (POM)	Aço Inoxidável NITRUM® Polioximetileno (POM)



283704

 300mm / 12"
424mm / 16,6"



Salmón // (Ancho-Con Alveolos)
Salmon Knife (Wide-Granton Edge)
C. Saumon (Large-Alvéolé)
Coltello Salmone (Largo-Con Alveole) // Salmão (Largo com Alvéolos)



284004

 290mm / 11"
410mm / 16,1"

Salmón // (Flexible-Con Alveolos)
Salmon Knife (Flexible-Granton Edge) // C. Saumon (Flexible-Alvéolé) // Coltello Salmone (Flessibile-Con Alveole) // Salmão (Flexível com Alvéolos)



	Estuche	Case	Étui	Astuccio	Estojo
	Acero Inoxidable NITRUM® Polioximetileno (POM)	NITRUM® Stainless Steel Polyoxymethylene (POM)	Acier Inoxydable NITRUM® Polyoxyméthylène (POM)	Acciaio Inossidabile NITRUM® Polioximetileno (POM)	Aço Inoxidável NITRUM® Polioximetileno (POM)



288400

 200mm / 8"
326mm / 12,8"
 2,5mm
 ≈ 390gr

Macheta China // Chinese Cleaver
Couperet Chinois // Mannaietta
Cinesa // Cutelo Chinês

	Funda Display	Display Sleeve	Carte	Display	Capa Expositora
	Acero Inoxidable NITRUM® Polioximetileno (POM)	NITRUM® Stainless Steel Polyoxymethylene (POM)	Acier Inoxydable NITRUM® Polyoxyméthylène (POM)	Acciaio Inossidabile NITRUM® Polioximetilene (POM)	Aço Inoxidável NITRUM® Polioximetileno (POM)







282404

 160mm / 6"
 282mm / 11,1"
 3mm
 ≈ 310gr

**Hachuela // Cleaver // Feuille
Mannaietta // Machados**



288200

 160mm / 6"
 298mm / 11,7"
 4mm
 ≈ 446gr

**Macheta // Cleaver // Couperet
Mannaietta // Machete**



288300

 180mm / 7"
 316mm / 12,4"
 4mm
 ≈ 480gr



**Macheta China // Chinese Cleaver
Couperet Chinois // Mannaietta
Cinesa // Cutelo Chinês**



286600

 160mm/6"
 320mm/12,5"

**Espátula // Spatula // Spatule à
Lasagne // Spatola // Espátula**

	Funda Display	Display Sleeve	Carte	Display	Capa Expositora
	Acero Inoxidable NITRUM® Polioximetileno (POM)	NITRUM® Stainless Steel Polyoxymethylene (POM)	Acier Inoxydable NITRUM® Polyoxyméthylène (POM)	Acciaio Inossidabile NITRUM® Polioximetileno (POM)	Aço Inoxidável NITRUM® Polioximetileno (POM)



286400

 125x90mm / 4,9x3,5"
260mm / 10,2"



Espátula // Spatula // Spatule à
Lasagne // Spatola // Espátula



286500

 125x120mm / 4,9x4,7"
260mm / 10,2"

Espátula // Spatula // Spatule à
Lasagne // Spatola // Espátula

	Estuche	Case	Étui	Astuccio	Estojo
	Acero Inoxidable NITRUM® Polioximetileno (POM)	NITRUM® Stainless Steel Polyoxymethylene (POM)	Acier Inoxydable NITRUM® Polyoxyméthylène (POM)	Acciaio Inossidabile NITRUM® Polioximetileno (POM)	Aço Inoxidável NITRUM® Polioximetileno (POM)



286104

 205mm / 8"
340mm / 13,3"

Espátula // Spatula // Spatule
Spatola // Espátula



286204

 250mm / 10"
390mm / 15,3"



Espátula // Spatula // Spatule
Spatola // Espátula



286304

 300mm / 12"
440mm / 17,3"

Espátula // Spatula // Spatule
Spatola // Espátula

	Caja	Box	Boîte	Scatola	Caixa
	Acero Inoxidable NITRUM® Polioximetileno (POM)	NITRUM® Stainless Steel Polyoxymethylene (POM)	Acier Inoxydable NITRUM® Polyoxyméthylène (POM)	Acciaio Inossidabile NITRUM® Polioximetilene (POM)	Aço Inoxidável NITRUM® Polioximetileno (POM)

282904



 150mm / 6"
276mm / 10,8"

Carnicero // Butcher Knife
C. Boucher // Coltello Scannare
Carniceiro

283004



 175mm / 7"
300mm / 11,8"

Carnicero // Butcher Knife
C. Boucher // Coltello Scannare
Carniceiro

283104



 200mm / 8"
336mm / 13,2"

Carnicero // Butcher Knife
C. Boucher // Coltello Scannare
Carniceiro

283204



 250mm / 10"
382mm / 15"

Carnicero // Butcher Knife
C. Boucher // Coltello Scannare
Carniceiro

283304





 300mm / 12"
434mm / 17"

Carnicero // Butcher Knife
C. Boucher // Coltello Scannare
Carniceiro

286700





 275mm / 11"
399mm / 15,7"
 4mm
 ≈ 645gr



Carnicero // Butcher Knife
C. Boucher // Coltello Scannare
Carniceiro

286800







 300mm / 12"
426mm / 16,7"
 4mm
 ≈ 717gr

Carnicero // Butcher Knife
C. Boucher // Coltello Scannare
Carniceiro

	Caja	Box	Boîte	Scatola	Caixa
	Acero Inoxidable NITRUM® Polioximetileno (POM)	NITRUM® Stainless Steel Polyoxymethylene (POM)	Acier Inoxydable NITRUM® Polyoxyméthylène (POM)	Acciaio Inossidabile NITRUM® Polioximetilene (POM)	Aço Inoxidável NITRUM® Polioximetileno (POM)





287100

 290mm / 11"
 418mm / 16,4"
 2mm
 ≈ 475gr

Pescadero // Fishmonger Knife
C. Poisson // Coltello da Pesce
Para Peixe



287000

 300mm / 12"
 422mm / 16,6"
 2mm
 ≈ 551gr

Pescadero // Fishmonger Knife
C. Poisson // Coltello da Pesce
Para Peixe





287200

 320mm / 12"
 440mm / 17,3"
 2mm
 ≈ 539gr

Pescadero // Fishmonger Knife
C. Poisson // Coltello da Pesce
Para Peixe



287800

 220mm / 8"
 352mm / 13,8"
 4mm
 ≈ 837gr



Hachuela // Cleaver // Feuille
Mannaïetta // Machados



287900

 250mm / 10"
 383mm / 15"
 4mm
 ≈ 1050gr

Hachuela // Cleaver // Feuille
Mannaïetta // Machados

	Caja	Box	Boîte	Scatola	Caixa
	Acero Inoxidable NITRUM® Polioximetileno (POM)	NITRUM® Stainless Steel Polyoxymethylene (POM)	Acier Inoxydable NITRUM® Polyoxyméthylène (POM)	Acciaio Inossidabile NITRUM® Polioximetilene (POM)	Aço Inoxidável NITRUM® Polioximetileno (POM)



2879000



Hachuela // Cleaver // Feuille
Mannietta // Machados



287300

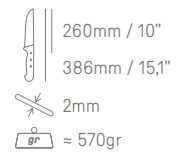

Filetera // Steak Cleaver
Couperet à Filet // Sfilettare
Filetagem



2873000

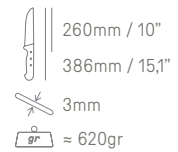



Filetera // Steak Cleaver
Couperet à Filet // Sfilettare
Filetagem



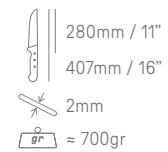



287400



Filetera // Steak Cleaver
Couperet à Filet // Sfilettare
Filetagem

	Caja	Box	Boîte	Scatola	Caixa
	Acero Inoxidable NITRUM® Polioximetileno (POM)	NITRUM® Stainless Steel Polyoxymethylene (POM)	Acier Inoxydable NITRUM® Polyoxyméthylène (POM)	Acciaio Inossidabile NITRUM® Polioximetileno (POM)	Aço Inoxidável NITRUM® Polioximetileno (POM)





2875000

 180mm / 7"
 312mm / 12,1"
 3mm
 ≈ 508gr

Chuletera // Chop Cleaver
 Couperet à Côtelette // Bistecca
 Para Costoletas



2878000

 220mm / 8"
 348mm / 13,7"
 3mm
 ≈ 620gr

Chuletera // Chop Cleaver
 Couperet à Côtelette // Bistecca
 Para Costoletas





2874000

 280mm / 11"
 406mm / 16"
 3mm
 ≈ 835gr

Chuletera // Chop Cleaver
 Couperet à Côtelette // Bistecca
 Para Costoletas





790900

 400mm / 16"
 656,5mm / 25,8"

Corta-Quesos // Cheese Knife
 Coupe Fromage // Taglia-
 Formaggio // Corta-Queijos





792400

 290mm / 11"
 598mm / 23,5"

Corta-Quesos // Cheese Knife
 Coupe Fromage // Taglia-
 Formaggio // Corta-Queijos



792300

 260mm / 10"
 526mm / 20,7"

Corta-Quesos // Cheese Knife
 Coupe Fromage // Taglia-
 Formaggio // Corta-Queijos

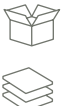

	Estuche	Case	Étui	Astuccio	Estojo
	Acero Inoxidable NITRUM® Polioximetileno (POM)	NITRUM® Stainless Steel Polyoxymethylene (POM)	Acier Inoxydable NITRUM® Polyoxyméthylène (POM)	Acciaio Inossidabile NITRUM® Polioximetilene (POM)	Aço Inoxidável NITRUM® Polioximetileno (POM)

285800

Juego 2 pzas. // 2 pc. Set
Ensemble 2 Ctx. // Set 2 Pezzi
Conjunto 2 Peças



2811 2806



285500

Juego 2 pzas. // 2 pc. Set
Ensemble 2 pièces // Set 2 Pezzi
Conjunto 2 Peças



7821 2818

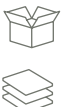

	Estuche	Case	Étui	Astuccio	Estojo
	Acero Inoxidable Nitrum® Polioximetileno (POM)	NITRUM® Stainless Steel Polyoxymethylene (POM)	Acier Inoxydable NITRUM® Polyoxyméthylène (POM)	Acciaio Inossidabile NITRUM® Polioximetilene (POM)	Aço Inoxidável NITRUM® Polioximetileno (POM)





2802 2846 2806



807410



Set 3 piezas // 3 pc. Set // Set 3 Ctx.
Set 3 Pezzi // Conjunto 3 Peças

	Caja Regalo	Gift Box	Boîte Cadeau	Scatola Regalo	Caixa de Presente
	Acero Inoxidable NITRUM® Polioxiometileno (POM)	NITRUM® Stainless Steel Polyoxymethylene (POM)	Acier Inoxydable NITRUM® Polyoxyméthylène (POM)	Acciaio Inossidabile NITRUM® Polioxiometilene (POM)	Aço Inoxidável NITRUM® Polioxiometileno (POM)
	Madera de Haya	Beech Wood	Bois de Hêtre	Legno di Faggio	Madeira de Faia

285600

Juego 6 piezas // 6 pc. Set
Bloc 6 Pièces // Ceppo 6 Pezzi
Conjunto 6 Peças





	Caja Regalo	Gift Box	Boîte Cadeau	Scatola Regalo	Caixa de Presente
	Acero Inoxidable NITRUM® Polioxiometileno (POM)	NITRUM® Stainless Steel Polyoxymethylene (POM)	Acier Inoxydable NITRUM® Polyoxyméthylène (POM)	Acciaio Inossidabile NITRUM® Polioxiometilene (POM)	Aço Inoxidável NITRUM® Polioxiometileno (POM)
	Madera de Caucho	Rubber Wood	Bois de Caoutchouc	Legno di Caucciù	Madeira de Borracha

285000

Juego 4 piezas // 4 pc. Set // Bloc 4
Pièces // Ceppo 4 Pezzi // Conjunto
4 Peças



	Caja Regalo	Gift Box	Boîte Cadeau	Scatola Regalo	Caixa de Presente
	Acero Inoxidable NITRUM® Polioximetileno (POM)	NITRUM® Stainless Steel Polyoxymethylene (POM)	Acier Inoxydable NITRUM® Polyoxyméthylène (POM)	Acciaio Inossidabile NITRUM® Polioximetilene (POM)	Aço Inoxidável NITRUM® Polioximetileno (POM)
	Madera de Haya Lacada Color Nogal	Walnut Lacquered Beech Wood	Bois de Hêtre Couleur Noyer Couleur Noyer	Legno di Faggio Laccato in Color Noce	Madeira de Faia Lacada À Cor de Nogueira



285700

Juego 5 piezas // Juego 5 pzas.
5 pc. set // Bloc 5 Ctx. // Ceppo 5
Pezzi // Conjunto 5 Peças



SERIE COLOUR PRO

Ergonomía y durabilidad, fusionadas para el día a día del mundo industrial. Su acero resiste el paso del tiempo, mientras que su revolucionario mango ergonómico, de polipropileno cubierto en caucho, promete comodidad y adaptabilidad.

Ergonomics and durability, combined for daily use in the industrial world. Its steel withstands the test of time, while its revolutionary ergonomic handle, made of polypropylene covered in rubber, promises comfort and adaptability.

L'alliance parfaite entre ergonomie et durabilité pour une utilisation quotidienne en milieu professionnel. Son acier résiste à l'épreuve du temps, tandis que son manche exceptionnellement ergonomique, en polypropylène, promet confort et adaptabilité.

Ergonomia e durevolezza si fondono per la quotidianità del mondo industriale. Il suo acciaio resiste al trascorrere del tempo, mentre il suo rivoluzionario manico ergonomico in polipropilene rivestito di caucciù garantisce comodità e adattabilità.

Ergonomia e durabilidade, fundidas para o dia a dia do mundo industrial. O seu aço resiste o passar do tempo, enquanto o seu revolucionário cabo ergonómico, em polipropileno revestido a borracha, promete conforto e adaptabilidade.



Acero Inoxidable NITRUM®

NITRUM® Stainless Steel · Acier Inoxydable NITRUM®
Acciaio Inossidabile NITRUM® · Aço Inoxidável NITRUM®.

Bactiproof Silver®

Doble Inyección

Double Injection · Double Injection · Doppia Iniezione
Injecção Dupla.

Resistente Altas Temperaturas

High-Temperature Resistant · Résistant aux Hautes
Températures · Resistente alle Alte Temperature Resistência a
Altas Temperaturas.

Plásticos Técnicos (PP+TPE)

Technical Plastics (Polipropileno + Elastomer) · Plastiques
Techniques (Polypropylene + Élastomère) · Plastiche
Tecniche (Polypropylène + Elastomero) · Plásticos Técnicos
(Polipropilene + Elastômero).

NSF National Sanitary Foundation

ICE PLUS®

Antideslizante

Non-Slipn · Antidérapant · Antiscivolo · Antiderrapante.



MANGOS

MANGOS IDENTIFICATIVOS
IDENTIFICATION HANDLES
IDENTIFICATION DES MANCHES
IDENTIFICAZIONE DEI MANICI
CABOS IDENTIFICADORES

IDENTIFICADORES DE COLORES:

El mango de cada cuchillo identifica el tipo de alimentos en el que se va a emplear, mediante el uso de unos tapones de polipropileno de distintos colores se consigue un perfecto control higiénico-sanitario tal como especifican las normas europeas sanitarias de control alimentario.

COLOUR IDENTIFICATION SYSTEM:

Thanks to the colour of the knife handle one can know what type of food to use. This differentiation is made thanks to the polypropylene plugs of different colours which enable a comprehensive hygienic-sanitary control, complying with European hygiene of foodstuffs health regulations.

IDENTIFICATION DES COULEURS:

La couleur du manche du couteau permet de savoir le type d'aliments auxquels il est destiné. Ce type de distinction est possible grâce à des clips en Polypropylène de différentes couleurs permettant un contrôle hygiénique-sanitaire exhaustif, conformément aux normes de santé européennes dans le cadre du contrôle alimentaire.

IDENTIFICAZIONE DEI COLORI:

Grazie al colore del manico del coltello, possiamo sapere per quali tipi di alimenti sia indicato. Questa differenziazione è data da dei tappi di Polipropilene di vari colori, che consentono un controllo igienico-sanitario completo, rispettando le norme europee sanitarie di controllo dell'alimentazione.

IDENTIFICADORES DE COR:

A alça de cada faca identifica o tipo de alimento para o qual é destinada, por meio do uso de tampas de polipropileno de cores diferentes, garantindo um controle higiênico-sanitário perfeito, conforme especificado pelas normas europeias de controle de alimentos.

ALIMENTOS COCINADOS

COOKED MEATS
VIANDE CUIE ET
CHACUTERIE
ALIMENTI CUCINATI
ALIMENTOS COZIDOS



CARNE

RAW MEAT
VIANDE CRUE
CRUES CARNE
CARNE



PESCADO

RAW FISH
POISSON CRU
PESCE
PEIXE



FRUTAS Y ENSALADAS

ENSALADAS Y FRUTAS
SALADS AND FRUITS
FRUITS ET SALADES
FRUTTA O MACEDONIE
SALADAS E FRUTAS



VERDURAS

RAW VEGETABLES
LÉGUMES CRUS
VERDURE
VEGETAIS



PASTELERÍA Y LÁCTEOS



BAKERY AND
DAIRY PRODUCTS
LAITAGES PAINS ET
VIENNOISERIES
PANE E PASTICCERIAS
PADARIA E LATICÍNIOS



ALÉRGENOS

ALÉRGENOS
ALLERGENS
ALLERGÈNES
ALLERGENI
ALÉRGENOS



	Funda Display Acero Inoxidable NITRUM®	Display Sleeve NITRUM® Stainless Steel	Carte Acier Inoxydable NITRUM®	Display Acciaio Inossidabile NITRUM®	Capa Expositora Aço Inoxidável NITRUM®
	Polipropileno Recubierto con Elastómero	Polypropylene Covered by Elastomer	Polypropylène Recouvert d'Élastomère	Polipropilene Ricoperto con Elastomero	Polipropileno Revestido a Elastômero



240000

80mm / 3"
191mm / 7,5"

Mondador // Paring Knife
C. Office // Spelucchino
Descascador



241300

100mm / 4"
208mm / 8,1"

Mondador // Paring Knife
C. Office // Spelucchino
Descascador



243100

170mm / 7"
310mm / 12,2"

Lenguado (Flexible) // Sole
Knife (Flexible) // C. Filet de Sole
(Flexible) // Coltello Sogliola
(Flessibile) // Linguado (Flexível)



243200

190mm / 7"
332mm / 13"

Fileteador (Semiflexible)
Fillet Knife (Semi-flexible) // C. À
Dénerver (Semi-flexible) // Coltello
Filettare Pesce (Semiflessibile)
Filetar (Semiflexível)



241000

200mm / 8"
330mm / 12,9"

Cocinero // Chef's Knife
C. Cuisine // Coltello Cucina
Cozinheiro



241100

250mm / 10"
386mm / 15,1"



Cocinero // Chef's Knife
C. Cuisine // Coltello Cucina
Cozinheiro



241200

300mm / 12"
439mm / 17,2"

Cocinero // Chef's Knife
C. Cuisine // Coltello Cucina
Cozinheiro

	Funda Display Acero Inoxidable NITRUM®	Display Sleeve NITRUM® Stainless Steel	Carte Acier Inoxydable NITRUM®	Display Acciaio Inossidabile NITRUM®	Capa Expositora Aço Inoxidável NITRUM®
	Polipropileno Recubierto con Elastómero	Polypropylene Covered by Elastomer	Polypropylène Recouvert d'Élastomère	Polipropilene Ricoperto con Elastomero	Polipropileno Revestido a Elastômero



244100

130mm / 5"
264mm / 10,3"

Carnicero // Sticking Knife
C. Saigner // Coltello Scannare
Carniceiro



243000

150mm / 6"
284mm / 11,1"

Carnicero // Sticking Knife
C. Saigner // Coltello Scannare
Carniceiro



241400

130mm / 5"
265mm / 10,4"

Carnicero // Sticking Knife
C. à Découper // Coltello Scannare
Carniceiro



241500

160mm / 6"
300mm / 11,8"

Carnicero // Sticking Knife
C. à Découper // Coltello Scannare
Carniceiro



241600

180mm / 7"
317mm / 12,4"



Carnicero // Sticking Knife
C. à Découper // Coltello Scannare
Carniceiro



241700

200mm / 8"
329mm / 12,9"

Carnicero // Sticking Knife
C. à Découper // Coltello Scannare
Carniceiro

	Funda Display Acero Inoxidable NITRUM®	Display Sleeve NITRUM® Stainless Steel	Carte Acier Inoxydable NITRUM®	Display Acciaio Inossidabile NITRUM®	Capa Expositora Aço Inoxidável NITRUM®
	Polipropileno Recubierto con Elastómero	Polypropylene Covered by Elastomer	Polypropylène Recouvert d'Élastomère	Polipropilene Ricoperto con Elastomero	Polipropileno Revestido com Elastômero

240100

 150mm / 5"
284mm / 11,1"

Carnicero // Butcher Knife
Couteau Boucher // Coltello
Scannare // Carniceiro



240200

 180mm / 7"
310mm / 12,2"

Carnicero // Butcher Knife
Couteau Boucher // Coltello
Scannare // Carniceiro



240300

 200mm / 8"
334mm / 13,1"

Carnicero // Butcher Knife
Couteau Boucher // Coltello
Scannare // Carniceiro



240500

 250mm / 10"
393mm / 15,4"

Carnicero // Butcher Knife
Couteau Boucher // Coltello
Scannare // Carniceiro



240600

 300mm / 12"
442mm / 17,4"

Carnicero // Butcher Knife
Couteau Boucher // Coltello
Scannare // Carniceiro



240700

 350mm / 14"
490mm / 19,2"

Carnicero // Butcher Knife
C. Boucher // Coltello Scannare
Carniceiro





240800

 350mm / 14"
490mm / 19,2"

Pescadero (Sierra) // Fish Knife
(Serrated) // C. Poisson (Cranté)
Coltello Pesce (Seghettato)
Para Peixe (Perolado)



	Funda Display Acero Inoxidable NITRUM®	Display Sleeve NITRUM® Stainless Steel	Carte Acier Inoxydable NITRUM®	Display Acciaio Inossidabile NITRUM®	Capa Expositora Aço Inoxidável NITRUM®
	Polipropileno Recubierto con Elastómero	Polypropylene Covered by Elastomer	Polypropylène Recouvert d'Élastomère	Polipropilene Ricoperto con Elastomero	Polipropileno Revestido a Elastômero



242000

130mm / 6"
275mm / 10,8"

Deshuesador // Boning Knife
Couteau à Désosser // Coltello
Disosso Para Desossar



242200

140mm / 5"
281mm / 11"

Deshuesador Curvo // Boning Knife
Curved // Couteau à Désosser
Courbe // Coltello Disosso Curvo //
Para Desossar Curvo



242100

150mm / 6"
292mm / 11,4"

Deshuesador // Boning Knife
Couteau à Désosser // Coltello
Disosso Para Desossar



242300

150mm / 6"
292mm / 11,4"

Deshuesador // Boning Knife
Couteau à Désosser // Coltello
Disosso Para Desossar



242500

200mm / 8"
333mm / 13,1"

Fileteador (Flexible) // Fillet Knife
(Flexible) // C. filets (Flexible)
Coltello Filettare Pesce (Flessibile)
Filetar (Flexível)





245400

180mm / 7"
307mm / 12"

Santoku (Con Alveolos) //
Santoku Knife (Granton Edge)
C. Santoku (Alvéolé) // Coltello
Santoku (Con Alveole) // Rocking
Santoku (Com Alveolos)



	Funda Display Acero Inoxidable NITRUM®	Display Sleeve NITRUM® Stainless Steel	Carte Acier Inoxydable NITRUM®	Display Acciaio Inossidabile NITRUM®	Capa Expositora Aço Inoxidável NITRUM®
	Polipropileno Recubierto con Elastómero	Polypropylene Covered by Elastomer	Polypropylène Recouvert d'Élastomère	Polipropilene Ricoperto con Elastomero	Polipropileno Revestido A Elastômero



242800

 250mm / 10"
380mm / 14,9"

Pastelero (Sierra) // Pastry Knife (Serrated) // C. Genoise (Cranté) Coltello Pasticceria-Pane (Seghettato) // Pasteleiro (Perolado)



243500

 300mm / 12"
440mm / 17,3"

Pastelero (Sierra) // Pastry Knife (Serrated) // C. Genoise (Cranté) Coltello Pasticceria-Pane (Seghettato) // Pasteleiro (Perolado)



242900

 360mm / 10"
510mm / 20"

Fiambre // Slicing Knife Couteau Jambon // Coltello Prosciutto // Fiambre



242600

 300mm / 12"
441mm / 17,3"

Jamonero (Flexible) // Slicing Knife (Flexible) // C. Jambon (Flexible) Coltello Prosciutto (Flessibile) Para Presunto (Flexível)



242700

 300mm / 12"
441mm / 17,3"

Salmon // (Flexible-Con Alveolos) Salmon Knife (Flexible-Granton Edge) // C. Saumon (Flexible-Alvéole) // Coltello Salmone (Flessibile-Con Alveole) // Salmão (Flexível com Alveolos)





SERIE 2900 PRO

Ergonomía que facilita y resistencia que desafía el uso continuo. Esta serie es la elección para quienes valoran la eficiencia y el confort en trabajos exigentes, con la confianza de un control higiénico superior gracias a la diferenciación de cuchillos según el color del mango.

Ergonomics that favours and strength that withstands continual use. This series is the perfect choice for anyone who values efficiency and comfort in demanding jobs, with the reliability of an advanced hygienic control thanks to the colour of the handle that differentiates the knives.

Une ergonomie qui facilite la tâche et une robustesse qui permet une utilisation prolongée. Cette série est le choix de tous ceux qui apprécient l'efficacité et le confort dans les travaux exigeants, avec la confiance d'un contrôle hygiénique supérieur grâce à la différenciation des couteaux en fonction de la couleur de leur manche.

Ergonomia che agevola e resistenza che sfida l'uso continuo. Questa serie è la scelta perfetta per chi apprezza l'efficienza e il comfort nei lavori esigenti, sempre con la sicurezza di un controllo igienico superiore, grazie alla distinzione dei coltelli in base al colore del manico.

Ergonomia que facilita e resistência que desafia o uso contínuo. Esta série é a escolha para quem valoriza a eficácia e o conforto em trabalhos exigentes, com a confiança de um controlo higiénico superior graças à diferenciação das facas pela cor do cabo.



Acero Inoxidable NITRUM®

NITRUM® Stainless Steel · Acier Inoxydable NITRUM®
Acciaio Inossidabile NITRUM® · Aço Inoxidável NITRUM®.

 **Bactiproof Silver®**

 **Inyección**

Inyección · Injection · Iniezione · Injecção

 **Antideslizante**

Non-Slip · Antidérapant · Antiscivolo · Antiderrapante.

Plásticos Técnicos (PP)

Technical Plastics (Polipropileno) · Plastiques Techniques
(Polypropylene) · Plastiche Tecniche (Polypropylène)
Plásticos Técnicos (Polipropileno)

 **Resistente Altas Temperaturas**

High-Temperature Resistant · Résistant aux Hautes
Températures · Resistente alle Alte Temperature
Resistência a Altas Temperaturas.

 **National Sanitary Foundation**



MANGOS

MANGOS IDENTIFICATIVOS
IDENTIFICATION HANDLES
IDENTIFICATION DES MANCHES
IDENTIFICAZIONE DEI MANICI
CABOS IDENTIFICADORES

IDENTIFICADORES DE COLORES:

El mango de cada cuchillo identifica el tipo de alimentos en el que se debe emplear. Mediante el uso de distintos colores, se consigue un perfecto control higiénico-sanitario tal como especifican las normas europeas sanitarias de control alimentario.

COLOUR IDENTIFICATION:

The handle of each knife identifies the type of food for which the knife must be used. Through the use of various colours, a total hygienic-sanitary control is obtained as specified by the European food safety legislation.

IDENTIFIANTS DE COULEUR:

Le manche de chaque couteau permet l'identification du type d'aliments pour lequel il peut être utilisé. L'utilisation de différentes couleurs permet un contrôle hygiénique et sanitaire parfait, et sanitaire parfait, tel que spécifié par les normes européennes d'hygiène alimentaire.

IDENTIFICATORI DEI COLORI:

Il manico di ogni coltello identifica il tipo di alimenti con i quali si deve utilizzare. Grazie all'utilizzo di diversi colori, si ottiene un perfetto controllo igienico-sanitario, come specificato nelle norme sanitarie europee per il controllo alimentare.

IDENTIFICADORES DE CORES:

A alça de cada faca identifica o tipo de alimentos para os quais deve ser usada. Através do uso de diferentes cores, obtém-se um controle higiénico-sanitário perfeito, conforme especificado pelas normas europeias de controle sanitário de alimentos.

ALIMENTOS COCINADOS

COOKED MEATS
VIANDES CUITES ET
CHARCUTERIES
ALIMENTI CUCINATI
ALIMENTOS COZIDOS



FRUTAS Y ENSALADAS

ENSALADAS Y FRUTAS
SALADS AND FRUITS
FRUITS ET SALADES
FRUTTA O MACEDONIE
SALADAS E FRUTAS



CARNE

RAW MEAT
VIANDES CRUES
CRUES CARNE
CARNE



PESCADO

RAW FISH
POISSONS CRU
PESCE
PEIXE



PASTELERÍA Y LÁCTEOS

BAKERY AND
DAIRY PRODUCTS
LAITAGES PAINS ET
VIENNOISERIES
PANE E PASTICCERIAS
PADARIA E LATICÍNIOS



MULTIUSOS

UTILITY KNIFE
COUTEAUX
MULTIFONCTIONS
MULTIUSOS
MULTIUSO



VERDURAS



RAW VEGETABLES
LÉGUMES CRUS
VERDURE
VEGETAIS



ALÉRGENOS

ALÉRGENOS
ALLERGENS
ALLERGÈNES
ALLERGENI
ALÉRGENOS



	Funda Display	Display Sleeve	Carte	Display	Capa Expositora
	Acero Inoxidable NITRUM® Polipropileno (PP)	NITRUM® Stainless Steel Polypropylene (PP)	Acier Inoxydable NITRUM® Polypropylène (PP)	Acciaio Inossidabile NITRUM® Polipropilene (PP)	Aço Inoxidável NITRUM® Polipropileno (PP)

● 290021 ● 290022 ● 290023 ● 290025 ● 290031



290000

80mm / 3"
190mm / 7,4"

Mondador // Paring Knife
Couteau Office // Spelucchino
Descascador

● 290121 ● 290122 ● 290123 ● 290125



290100

100mm / 4"
210mm / 8,2"

Verduras // Vegetable Knife
Couteau Légumes // Coltello
Verdura // Legumes

● 294422 ● 294425



294400

130mm / 5"
263mm / 10,3"

Deshuesador // Boning Knife
Couteau à Désosser // Coltello
Disosso Para Desossar

● 290421 ● 290422 ● 290423 ● 290425 ● 290431



290400

130mm / 5"
260mm / 10,2"

Cocina // Kitchen Knife
Couteau à Découper // Coltello
Cucina // Cozinha

● 290521 ● 290522 ● 290523 ● 290525



290500

150mm / 6"
271mm / 10,6"

Cocina // Kitchen Knife
Couteau à Découper // Coltello
Cucina // Cozinha

● 292121 ● 292122 ● 292123 ○ 292124 ● 292125 ● 292128 ● 292131



292100

200mm / 8"
332mm / 13"

Cocinero // Chef's Knife
Couteau Chef // Coltello Cucina
Cozinheiro



● 292115



292110

200mm / 8"
332mm / 13"

Cocinero (Sierra) // Chef's Knife
(Serrated) // Couteau Chef (Cranté)
Coltello Cucina (Seghettato)
Cozinheiro (Perolado)

	Funda Display	Display Sleeve	Carte	Display	Capa Expositora
	Acero Inoxidable NITRUM® Polipropileno (PP)	NITRUM® Stainless Steel Polypropylene (PP)	Acier Inoxydable NITRUM® Polypropylène (PP)	Acciaio Inossidabile NITRUM® Polipropilene (PP)	Aço Inoxidável NITRUM® Polipropileno (PP)



● 292021 ● 292022 ● 292023 ● 292025

292000

150mm / 6"
282mm / 11,1"

Cocinero // Chef's Knife
Couteau Chef // Coltello Cucina
Cozinheiro



● 290721 ● 290722 ● 290723 ○ 290724 ● 290725 ● 290728

290700

200mm / 8"
336mm / 13,2"

Cocinero (Ancho) // Chef's Knife
(Wide) // Couteau Chef (Large)
Coltello Cucina (Largo)
Cozinheiro (Largo)



● 290821 ● 290822 ● 290823 ○ 290824 ● 290825 ● 290828

290800

250mm / 10"
387mm / 15,2"

Cocinero (Ancho) // Chef's Knife
(Wide) // Couteau Chef (Large)
Coltello Cucina (Largo)
Cozinheiro (Largo)



● 290921 ● 290922 ● 290923 ● 290925

290900

300mm / 12"
435mm / 17,1"

Cocinero (Ancho) // Chef's Knife
(Wide) // Couteau Chef (Large)
Coltello Cucina (Largo)
Cozinheiro (Largo)

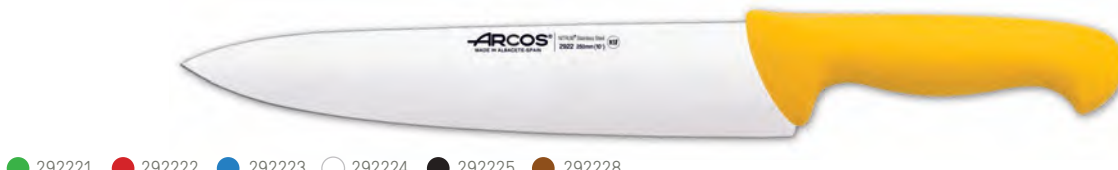

● 292221 ● 292222 ● 292223 ○ 292224 ● 292225 ● 292228

292200

250mm / 10"
383mm / 15"

Cocinero // Chef's Knife
Couteau Chef // Coltello Cucina
Cozinheiro



● 292215

292210

250mm / 10"
383mm / 15"

Cocinero (Sierra) // Chef's Knife
(Serrated) // Couteau Chef
(Cranté) // Coltello Cucina
(Seghettato) // Cozinheiro
(Perolado)





● 292321 ● 292322 ● 292325

292300

300mm / 12"
432mm / 17"

Cocinero // Chef's Knife
Couteau Chef // Coltello Cucina
Cozinheiro

	Funda Display	Display Sleeve	Carte	Display	Capa Expositora
	Acero Inoxidable NITRUM® Polipropileno (PP)	NITRUM® Stainless Steel Polypropylene (PP)	Acier Inoxydable NITRUM® Polypropylène (PP)	Acciaio Inossidabile NITRUM® Polipropilene (PP)	Aço Inoxidável NITRUM® Polipropileno (PP)

292900



130mm / 5"
274mm / 10",7

Carnicero // Butcher Knife
C. Saigner // Coltello Macellaio
Carniceiro

● 292922 ● 292923 ● 292925

293000



150mm / 6"
290mm / 11,4"

Carnicero // Butcher Knife
C. Saigner // Coltello Macellaio
Carniceiro

● 293022 ● 293023 ● 293025

294600



160mm / 6"
306mm / 12"

Carnicero // Butcher Knife
C. à Découper // Coltello Macellaio
Carniceiro

● 294622 ● 294623 ● 294625

294700



180mm / 7"
323mm / 12,7"

Carnicero // Butcher Knife
C. à Découper // Coltello Macellaio
Carniceiro

● 294722 ● 294723 ● 294725

294800



200mm / 8"
336mm / 13,2"

Carnicero // Butcher Knife
C. à Découper // Coltello Macellaio
Carniceiro

● 294822 ● 294823 ● 294825



296510



250mm / 10"
400mm / 15,7"

Carnicero Curvo // Curved Butcher Knife
C. à Parer Courbe
Coltello Macellaio Curvo
Carniceiro Curvo

● 256515

	Funda Display	Display Sleeve	Carte	Display	Capa Expositora
	Acero Inoxidable NITRUM® Polipropileno (PP)	NITRUM® Stainless Steel Polypropylene (PP)	Acier Inoxydable NITRUM® Polypropylène (PP)	Acciaio Inossidabile NITRUM® Polipropilene (PP)	Aço Inoxidável NITRUM® Polipropileno (PP)

● 291522 ● 291523 ● 291525



291500

160mm / 5"
292mm / 11,4"

Carnicero // Butcher Knife
C. Boucher // Coltello Macellaio
Carniceiro

● 291622 ● 291623 ● 291625



291600

180mm / 7"
318mm / 12,5"

Carnicero // Butcher Knife
C. Boucher // Coltello Macellaio
Carniceiro

● 291722 ● 291723 ● 291725



291700

210mm / 8"
338mm / 13,3"

Carnicero // Butcher Knife
C. Boucher // Coltello Macellaio
Carniceiro

● 291822 ● 291823 ● 291825



291800

250mm / 10"
403mm / 15,8"

Carnicero // Butcher Knife
C. Boucher // Coltello Macellaio
Carniceiro



● 291922 ● 291923 ● 291925



291900

300mm / 12"
438mm / 17,2"

Carnicero // Butcher Knife
C. Boucher // Coltello Macellaio
Carniceiro

	Funda Display	Display Sleeve	Carte	Display	Capa Expositora
	Acero Inoxidable NITRUM® Polipropileno (PP)	NITRUM® Stainless Steel Polypropylene (PP)	Acier Inoxydable NITRUM® Polypropylène (PP)	Acciaio Inossidabile NITRUM® Polipropilene (PP)	Aço Inoxidável NITRUM® Polipropileno (PP)



295800

170mm / 7"
305mm / 12"

Carnicero (Ancho) // Butcher Knife (Wide) // C. Boucher (Large) Coltello Affettare (Largo) Talhante (Largo)

● 295822 ● 295823 ● 295825



295900

200mm / 8"
337mm / 13,2"

Carnicero (Ancho) // Butcher Knife (Wide) // C. Boucher (Large) Coltello Affettare (Largo) Talhante (Largo)

● 295922 ● 295923 ● 295925



296000

250mm / 10"
384mm / 15,11"

Carnicero (Ancho) // Butcher Knife (Wide) // C. Boucher (Large) Coltello Affettare (Largo) Talhante (Largo)

● 296022 ● 296023 ● 296025



292400

350mm / 14"
492mm / 19,3"

Carnicero // Butcher Knife C. Boucher // Coltello Macellaio Carniceiro

● 292422 ● 292423 ● 292425





292500

350mm / 14"
492mm / 19,3"

Pescadero (Sierra) // Fish Knife (Serrated) // Coureau Poisson (Cranté) // Coltello Pesce (Seghettato) // Para Peixe (Perolado)

● 292522 ● 292523 ● 292525

	Funda Display	Display Sleeve	Carte	Display	Capa Expositora
	Acero Inoxidable NITRUM® Polipropileno (PP)	NITRUM® Stainless Steel Polypropylene (PP)	Acier Inoxydable NITRUM® Polypropylène (PP)	Acciaio Inossidabile NITRUM® Polipropilene (PP)	Aço Inoxidável NITRUM® Polipropileno (PP)



290600



180mm / 7"
312mm / 12,2"

Santoku (Con Alveolos)
Santoku Knife (Granton Edge)
C. Santoku (Alvéolé) // Coltello
Santoku (Con Alveole) // Santoku
(com Alveolos)

● 290621 ● 290622 ● 290623 ● 290625



293100

170mm / 7"
298mm / 11,7"

Lenguado (Flexible) // Sole
Knife (Flexible) // C. Filet de Sole
(Flexible) // Coltello Sogliola
(Flessibile) // Linguado (Flexível)

● 293123 ● 293125



295200

190mm / 7"
320mm / 12,5"

Fileteador (Semiflexible)
Slicing Knife (Semiflexible)
C. À Dénerver (Semiflexible)
Coltello Filettare Pesce
(Semiflessibile) // Filetar
(Semiflexível)

● 295222 ● 295223 ● 295225



295100

200mm / 8"
330mm / 12,9"

Fileteador (Flexible) // Fillet Knife
(Flexible) // C. Filets (Flexible)
(Flexible) // Coltello Filettare Pesce
(Flessibile) // Filetar (Flexível)

● 295122 ● 295123 ● 295125



295500

250mm / 10"
392mm / 15,4"

Trinchante // Carving knife
C. Tranchelard // Coltello Trinciante
Trinchante

● 295522 ● 295525





290300

180mm / 7"
314mm / 12,3"

Tenedor Trinchante // Carving Fork
Fourchette Diapason
Forchettone // Garfo Trinchante

● 290325

	Funda Display	Display Sleeve	Carte	Display	Capa Expositora
	Acero Inoxidable NITRUM® Polipropileno (PP)	NITRUM® Stainless Steel Polypropylene (PP)	Acier Inoxydable NITRUM® Polypropylène (PP)	Acciaio Inossidabile NITRUM® Polipropilene (PP)	Aço Inoxidável NITRUM® Polipropileno (PP)

● 294225



294200

100mm / 4"
243mm / 9,5"

Deshuesador // Boning Knife
C. à Désosser // Coltello Disosso
Para Desossar

● 291222 ● 291223 ● 291225



291200

140mm / 5"
278mm / 10,9"

Deshuesador Curvo (Semiflexible)
Boning Knife Curved (Semi-flexible)
C. à Désosser Courbe (Semi-flexible) // Coltello Disosso Curvo (Semiflessibile) // Para Desossar Curvo (Semiflexível)

● 291322 ● 291323 ● 291325



291300

140mm / 5"
278mm / 10,9"

Deshuesador Curvo // Boning Knife Curved
C. à Désosser Courbe
Para Desossar Curvo

● 294022 ● 294025



294000

140mm / 5"
273mm / 10,7"

Deshuesador // Boning Knife
C. à Désosser // Coltello Disosso
Para Desossar

● 294122 ● 294125



294100

160mm / 6"
292mm / 11,4"

Deshuesador // Boning Knife
C. à Désosser // Coltello Disosso
Para Desossar



● 294521 ● 294522 ● 294523 ○ 294524 ● 294525



294500

160mm / 6"
295mm / 11,6"

Deshuesador // Boning Knife
C. à Désosser // Coltello Disosso
Para Desossar

	Funda Display	Display Sleeve	Carte	Display	Capa Expositora
	Acero Inoxidable NITRUM® Polipropileno (PP)	NITRUM® Stainless Steel Polypropylene (PP)	Acier Inoxydable NITRUM® Polypropylène (PP)	Acciaio Inossidabile NITRUM® Polipropilene (PP)	Aço Inoxidável NITRUM® Polipropileno (PP)

● 295322 ● 295323 ● 295325



295300

160mm / 6"
294mm / 11,5"

Despellejador // Skinning Knife
C. Dépouiller // Coltello Danese
Esfolar

● 295422 ● 295423 ● 295425



295400

190mm / 7"
322mm / 12,6"

Despellejador // Skinning Knife
C. Dépouiller // Coltello Danese
Esfolar

● 292622 ● 292623 ● 292625



292600

200mm / 8"
345mm / 13,5"

Carnicero // Butcher Knife
C. Boucher // Coltello Macellaio
Carniceiro

● 292721 ● 292722 ● 292723 ● 292725



292700

250mm / 10"
395mm / 15,5"

Carnicero // Butcher Knife
C. Boucher // Coltello Macellaio
Carniceiro



● 292822 ● 292823 ● 292825



292800

300mm / 12"
445mm / 17,5"

Carnicero // Butcher Knife
C. Boucher // Coltello Macellaio
Carniceiro

	Funda Display	Display Sleeve	Carte	Display	Capa Expositora
	Acero Inoxidable NITRUM® Polipropileno (PP)	NITRUM® Stainless Steel Polypropylene (PP)	Acier Inoxydable NITRUM® Polypropylène (PP)	Acciaio Inossidabile NITRUM® Polipropilene (PP)	Aço Inoxidável NITRUM® Polipropileno (PP)



○ 293224 ● 293225

293200

 250mm / 10"
385mm / 15"

Pastelero (Sierra) // Pastry Knife (Serrated) // C. Genoise (Cranté) Coltello Pasticceria-Panne (Seghettato) // Pasteleiro (Perolado)



○ 295024 ● 295025 ● 295028

295000

 250mm / 10"
395mm / 15,5"

Pastelero (Sierra) // Pastry Knife (Serrated) // C. Genoise (Cranté) Coltello Pasticceria-Panne (Seghettato) // Pasteleiro (Perolado)



○ 293724 ● 293725

293700

 300mm / 12"
445mm / 17,5"

Pastelero (Sierra Flexible) Pastry Knife (Serrated- Flexible) C. Genoise (Cranté-Flexible) Coltello Pasticceria-Panne (Seghettato-Flessibile) Pasteleiro (Flexível Perolado)



○ 293624 ● 293625

293600

 350mm / 14"
495mm / 19,4"

Pastelero (Sierra Flexible) Pastry Knife (Serrated-Flexible) C. Genoise (Cranté-Flexible) Coltello Pasticceria-Panne (Seghettato-Flessibile) Pasteleiro (Flexível Perolado)





○ 291424 ● 291425 ● 291431

291400

 200mm / 8"
320mm / 12,5"

Panero (Sierra) // Bread Knife (Serrated) // Couteau Pain (Cranté) Coltello Pane (Seghettato) // Para Pão (Perolado)

	Funda Display	Display Sleeve	Carte	Display	Capa Expositora
	Acero Inoxidable NITRUM® Polipropileno (PP)	NITRUM® Stainless Steel Polypropylene (PP)	Acier Inoxydable NITRUM® Polypropylène (PP)	Acciaio Inossidabile NITRUM® Polipropilene (PP)	Aço Inoxidável NITRUM® Polipropileno (PP)

● 294925



294900

250mm / 10"
395mm / 15,5"

Fiambre // Slicing Knife
C. Jambon // Coltello Prosciutto
Fiambre

● 293422 ● 293425



293400

300mm / 12"
445mm / 17,5"

Fiambre (Flexible) // Slicing Knife
(Flexible) // C. Jambon (Flexible)
Coltello Prosciutto (Flessibile)
Fiambre (Flexível)

● 293525



293500

350mm / 14"
495mm / 19,4"

Fiambre (Flexible) // Slicing Knife
(Flexible) // C. Jambon (Flexible)
Coltello Prosciutto (Flessibile)
Fiambre (Flexível)

● 293825



293800

400mm / 16"
530mm / 20,8"

Fiambre (Flexible) // Slicing Knife
(Flexible) // C. Jambon (Flexible)
Coltello Prosciutto (Flessibile)
Fiambre (Flexível)

● 291125



291100

240mm / 9"
360mm / 14,1"

Jamonero (Flexible) // Slicing Knife
(Flexible) // C. Jambon (Flexible)
Coltello Prosciutto (Flessibile)
Para Presunto (Flexível)



● 293322 ● 293323



293300

300mm / 12"
447mm / 17,5"

Salmón // (Flexible-Con Alveolos)
Salmon Knife (Flexible-Granton
Edge) // C. Saumon (Flexible-
Alvéolé) // Coltello Salmone
(Flessibile-Con Alveole) // Salmão
(Flexível com Alveolos)

	Funda Display	Display Sleeve	Carte	Display	Capa Expositora
	Acero Inoxidable NITRUM® Polipropileno (PP)	NITRUM® Stainless Steel Polypropylene (PP)	Acier Inoxydable NITRUM® Polypropylène (PP)	Acciaio Inossidabile NITRUM® Polipropilene (PP)	Aço Inoxidável NITRUM® Polipropileno (PP)



295700

 300mm / 12"
435mm / 17,1"

Salami // Salami Knife
Couteau Salami // Coltello Salami
Faca Salame

● 295725





298800

 410mm / 16"
545mm / 21,4"

Salami // Salami Knife
Couteau Salami // Coltello Salami
Faca Salame

● 298825

	Estuche	Case	Étui	Astuccio	Estojo
	Acero Inoxidable NITRUM® Polipropileno (PP)	NITRUM® Stainless Steel Polypropylene (PP)	Acier Inoxydable NITRUM® Polypropylène (PP)	Acciaio Inossidabile NITRUM® Polipropilene (PP)	Aço Inoxidável NITRUM® Polipropileno (PP)





298500

 200mm / 8"
330mm / 12,9"

 2,5mm



 ≈ 371gr

Macheta // Cleaver // Couperet
Mannietta // Machete

	Estuche	Case	Étui	Astuccio	Estojo
	Acero Inoxidable NITRUM® Polipropileno (PP)	NITRUM® Stainless Steel Polypropylene (PP)	Acier Inoxydable NITRUM® Polypropylène (PP)	Acciaio Inossidabile NITRUM® Polipropilene (PP)	Aço Inoxidável NITRUM® Polipropileno (PP)



296100



 190mm / 7"
325mm / 12,7"
 4mm
 ≈ 554gr

Hachuela // Cleaver // Feuille
Mannaietta // Machados

● 296122 ● 296123 ● 296125



296700



 200mm / 8"
330mm / 12,9"
 4mm
 ≈ 534gr

Macheta // Cleaver
Couperet // Mannaietta // Machete

● 296722 ● 296723 ● 296725



297000



 290mm / 11,4"
425mm / 16,7"
 2mm
 ≈ 410gr

Pescadero // Fishmonger Knife
Couteau Poisson // Coltello da
Pesce // Para Peixe

● 297023





297100

 320mm / 12,6"
448mm / 17,6" 5mm
 2mm
 ≈ 490gr

Pescadero // Fishmonger Knife
Couteau Poisson // Coltello da
Pesce // Para Peixe

● 297123

	Funda Display	Display Sleeve	Carte	Display	Capa Expositora
	Acero Inoxidable NITRUM® Polipropileno (PP)	NITRUM® Stainless Steel Polypropylene (PP)	Acier Inoxydable NITRUM® Polypropylène (PP)	Acciaio Inossidabile NITRUM® Polipropilene (PP)	Aço Inoxidável NITRUM® Polipropileno (PP)



297200



 200mm / 8"
338mm / 13,3"
 4mm
 ≈ 569gr

Macheta // Cleaver
Couperet // Mannaietta // Machete

● 297222 ● 297225



297500

 240mm / 9"
375mm / 14,7"
 4mm
 ≈ 711gr

Macheta // Cleaver
Couperet // Mannaietta // Machete

● 297522 ● 297525





297700

 220mm / 9"
355mm / 10"
 3mm
 ≈ 510gr

Chuletera // Chop Cleaver
Couperet à Côtelette // Bistecca
Para Costoletas



● 297722

	Estuche	Case	Étui	Astuccio	Estojo
	Acero Inoxidable NITRUM® Polipropileno (PP)	NITRUM® Stainless Steel Polypropylene (PP)	Acier Inoxydable NITRUM® Polypropylène (PP)	Acciaio Inossidabile NITRUM® Polipropilene (PP)	Aço Inoxidável NITRUM® Polipropileno (PP)



● 298122 ● 298123

298100

 260mm / 10,2"
391mm / 15.3"
 3mm
 ≈ 711gr

Chuletera // Chop Cleaver
Couperet à Côtelette // Bistecca
Para Costoletas





● 298322 ● 298223

298300

 280mm / 11"
412mm / 16.2"
 3mm
 ≈ 800gr

Chuletera // Chop Cleaver
Couperet à Côtelette // Bistecca
Para Costoletas

	Funda Display	Display Sleeve	Carte	Display	Capa Expositora
	Acero Inoxidable NITRUM® Polipropileno (PP)	NITRUM® Stainless Steel Polypropylene (PP)	Acier Inoxydable NITRUM® Polypropylène (PP)	Acciaio Inossidabile NITRUM® Polipropilene (PP)	Aço Inoxidável NITRUM® Polipropileno (PP)



299100

250mm / 10"
382mm / 15"

Espátula // Spatula // Spatule
Spatola // Espátula

● 299125



299600

125x90mm / 5x3"
263mm / 10,3"

Espátula // Spatula // Spatule
Spatola // Espátula

● 299625



299700

125x120mm / 5x5"
255mm / 10"

Espátula // Spatula // Spatule
Spatola // Espátula

● 299725



299500

155x90mm / 6x3"
270mm / 10,6"

Espátula // Spatula // Spatule
Spatola // Espátula

● 299525

ALÉRGENOS

COLOR DE MANGO PARA ALÉRGENOS

COLOURED HANDLE FOR ALLERGENS

UNE COULEUR DE MANCHE POUR SIGNALER LES ALLERGÈNES

COLORE DEL MANICO PER ALLERGENI

COR DO CABO PARA ALÉRGENOS



290031

100mm/3,9"



290431

130mm/5,1"



292131

200mm/7,8"



291431

200mm/7,8"



ARCOS presenta su propuesta de color de mango identificativo apto para el sistema de HACCP, con el fin de hacer la vida más fácil a aquellas personas que tienen algún tipo de alergia alimentaria. Una iniciativa pensada por ARCOS para evitar la contaminación cruzada, algo muy común en nuestras cocinas. Su mango de color fucsia nos indica que al hacer uso del mismo debemos evitar el contacto con otros alimentos alérgenos o superficies en las que anteriormente tocó un alimento que pueda afectar a la salud de la persona alérgica. Con esta propuesta, ARCOS busca concienciar de este problema que afecta a tanta gente y que debemos tener tan presente a la hora de tratar los alimentos.

ARCOS presents its identifying coloured handle design suitable for the HACCP system, so as to make life easier for those persons who suffer from food allergies. An initiative designed by ARCOS in order to avoid cross contamination, something which is very common in our kitchens. Its fuchsia handle shows that when one is using the knife is that contact with other food allergens or surfaces on which food has previously rested on that may affect the health of the allergy sufferer must be avoided. With this concept, ARCOS seeks to raise awareness of this problem which affects so many people and that must borne in mind when it comes to food.

ARCOS présente un nouveau manche dont la couleur sert d'élément d'identification, dans le but de simplifier la vie des personnes souffrant d'une quelconque intolérance alimentaire (gluten, lactose, etc.). Une initiative prise par ARCOS pour éviter la contamination croisée, un phénomène qui se produit très fréquemment dans nos cuisines. Son manche couleur fuchsia nous indique qu'au moment de nous en servir, nous devons éviter tout contact avec d'autres aliments allergènes ou des surfaces ayant été en contact auparavant avec un aliment pouvant nuire à la santé de la personne allergique. Au moyen de cette innovation, ARCOS cherche à mettre en évidence un problème qui concerne de nombreuses personnes et dont nous devons tenir compte au moment de manipuler les aliments. De plus, ce produit satisfait les exigences d'identification HACCP.

ARCOS presenta la sua proposta per il colore che indica il manico adatto per il sistema di HACCP, al fine semplificare la vita alle persone che hanno qualche tipo di allergia alimentare. Un'iniziativa di ARCOS per evitare il contagio incrociato, che è molto comune nelle nostre cucine. Il suo manico color fucsia indica che, utilizzandolo, dobbiamo evitare il contatto con altri alimenti allergeni o con superfici che abbiano precedentemente toccato un alimento che possa danneggiare la salute della persona allergica. Con questa proposta ARCOS cerca di sensibilizzare rispetto a questo problema, che riguarda molte persone e che dobbiamo tenere presente al momento di trattare gli alimenti.

ARCOS apresenta sua proposta de identificação de cor de cabo adequada ao sistema HACCP, com o objetivo de facilitar a vida daqueles que têm alguma alergia alimentar. Uma iniciativa pensada pela ARCOS para evitar a contaminação cruzada, algo muito comum em nossas cozinhas. Seu cabo de cor fúcsia indica que, ao usá-lo, devemos evitar o contato com outros alimentos alergênicos ou superfícies que anteriormente entraram em contato com alimentos que possam afetar a saúde da pessoa alérgica. Com essa proposta, a ARCOS busca conscientizar sobre esse problema que afeta tantas pessoas e que devemos ter em mente ao lidar com alimentos.

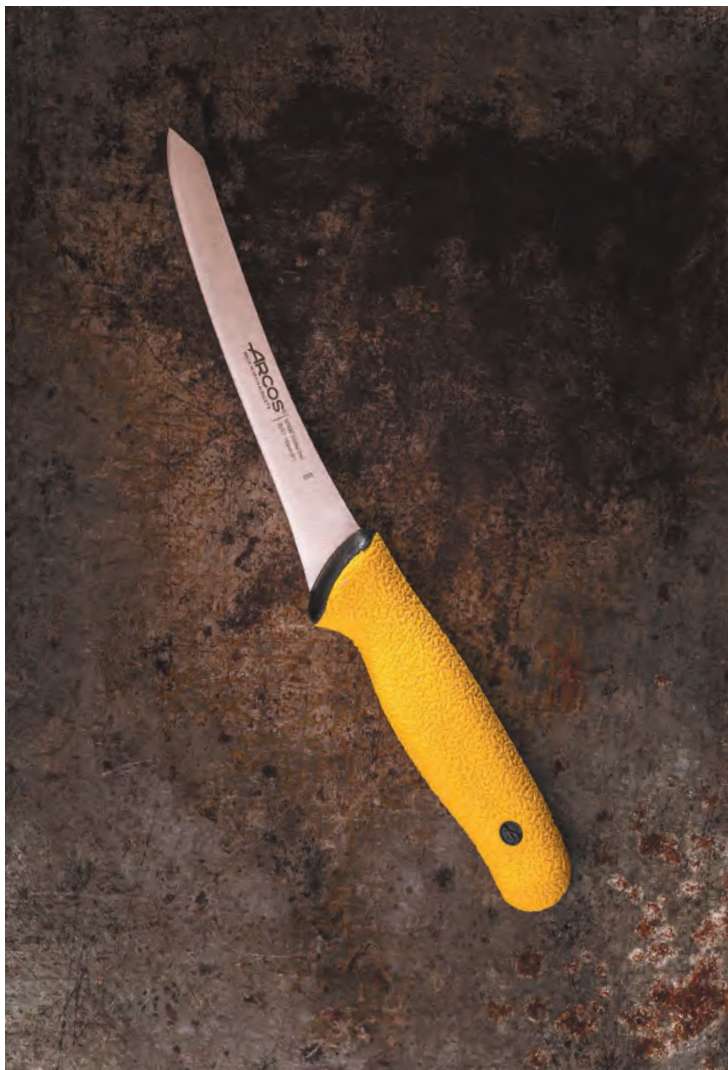

SERIE DÚO PRO

Serie de cuchillos profesionales, diseñados para mataderos y talleres de despiece. Destaca por sus mangos ergonómicos y antideslizantes, que garantizan un agarre firme y eficiencia para el trabajo diario. Su diseño permite aplicar mayor presión con el mínimo esfuerzo, reduciendo tanto la fatiga como el riesgo de lesiones musculoesqueléticas.

A series of professional knives, designed for slaughterhouses and butchery workshops. It stands out for its ergonomic and non-slip handles, ensuring a firm grip and efficiency for daily work. Its design allows for greater pressure application with minimal effort, reducing both fatigue and the risk of musculoskeletal injuries.

Une série de couteaux professionnels, conçue pour les abattoirs et les ateliers de découpe. Elle se distingue par ses poignées ergonomiques et antidérapantes, garantissant une prise ferme et une efficacité pour le travail quotidien. Son design permet d'exercer une plus grande pression avec un minimum d'effort, réduisant ainsi la fatigue et le risque de blessures musculo-squelettiques.

Una serie di coltelli professionali, progettati per macelli e laboratori di sezionamento. Si distingue per i suoi manici ergonomici e antiscivolo, garantendo una presa salda e un'efficienza per il lavoro quotidiano. Il suo design consente di applicare una maggiore pressione con il minimo sforzo, riducendo sia l'affaticamento che il rischio di lesioni muscoloscheletriche.

Uma série de facas profissionais, projetada para matadouros e oficinas de desossa. Destaca-se pelos seus cabos ergonómicos e antiderrapantes, garantindo uma pegada firme e eficiência no trabalho diário. O seu design permite aplicar maior pressão com o mínimo esforço, reduzindo tanto a fadiga quanto o risco de lesões musculoesqueléticas.



Acero Inoxidable NITRUM®

NITRUM® Stainless Steel · Acier Inoxydable NITRUM®
Acciaio Inossidabile NITRUM® · Aço Inoxidável NITRUM®.

Bactiproof Silver®

Doble Inyección

Double Injection · Double Injection · Doppia Iniezione
Injeção Dupla.

Resistente Altas Temperaturas

High-Temperature Resistant · Résistant aux Hautes
Températures · Resistente alle Alte Temperature Resistência a
Altas Temperaturas.

Plásticos Técnicos (PP+TPE)



Technical Plastics (Polipropileno + Elastomer) · Plastiques
Techniques (Polypropylene + Elastomère) · Plastiche
Tecniche (Polypropylène + Elastomero) · Plásticos Técnicos
(Polipropilene + Elastômero).

NSF National Sanitary Foundation

ICE PLUS®

Antideslizante

Non-Slipn · Antidérapant · Antiscivolo · Antiderrapante.

	Funda Cartón Hoja Acero Inoxidable Nitrum®	Cardboard sheath NITRUM® Stainless Steel	Étui Carton sur Lame Acier Inoxydable NITRUM®	Coprilama di Cartone Acciaio Inossidabile NITRUM®	Capa de Cartão Aço Inoxidável NITRUM®
	Polipropileno Recubierto con Elastómero	Polypropylene Covered by Elastomer	Polypropylène Recouvert d'Élastomère	Polipropilene Ricoperto con Elastomero	Polipropileno Revestido com Elastômero



NEW

201000

 140mm / 5"
270mm / 10,6"

Cuchillo Deshuesador Rígido
Rigid Boning Knife
Couteau à Désosser Rigide
Coltello Disosso Rígido
Faca para Desossar Rígida



NEW

201100

 140mm / 5"
270mm / 10,6"

Cuchillo Deshuesador Semirígido
Semi-flexible Boning Knife
Couteau À Désosser Semi-flexible
Coltello Disosso Semiflessibile
Faca para Desossar Semiflexível



NEW

201200

 140mm / 5"
270mm / 10,6"

Cuchillo Deshuesador Rígido
Rigid Boning Knife
Couteau À désosser Rigide
Coltello Disosso Rígido
Faca para Desossar Rígida





NEW

201300

 140mm / 5"
270mm / 10,6"

Cuchillo Deshuesador Semirígido
Semi-flexible Boning Knife
Couteau À Désosser Semi-flexible
Coltello Disosso Semiflessibile
Faca para Desossar Semiflexível



	Funda Cartón Hoja Acero Inoxidable Nitrum®	Cardboard Sheath NITRUM® Stainless Steel	Étui Carton sur Lame Acier Inoxydable NITRUM®	Coprilama di Cartone Acciaio Inossidabile NITRUM®	Capa de Cartão Aço Inoxidável NITRUM®
	Polipropileno Recubierto con Elastómero	Polypropylene Covered by Elastomer	Polypropylène Recouvert d'Élastomère	Polipropilene Ricoperto con Elastomero	Polipropileno Revestido com Elastômero



NEW

201400

160mm / 6"
290mm / 11,4"

Cuchillo Deshuesador Rígido
Rigid Boning Knife
Couteau À désosser Rigide
Coltello Disosso Rigido
Faca para Desossar Rígida



NEW

201500

160mm / 6"
290mm / 11,4"

Cuchillo Deshuesador Semirígido
Semi-flexible Boning knife
Couteau À désosser Semi-flexible
Coltello Disosso Semiflessibile
Faca para Desossar Semiflexível.



NEW

201600

160mm / 6"
288mm / 11,3"

Cuchillo Deshuesador Rígido
Rigid Boning Knife
Couteau À désosser Rigide
Coltello Disosso Rigido
Faca para Desossar Rígida



PUNTA
INCLINADA



NEW

201700

160mm / 6"
288mm / 11,3"

Cuchillo Deshuesador Semirígido
Semi-flexible Boning knife
Couteau À désosser Semi-flexible
Coltello Disosso Semiflessibile
Faca para Desossar Semiflexível.



PUNTA
INCLINADA

	Funda Cartón Hoja Acero Inoxidable Nitrum®	Cardboard Sheath NITRUM® Stainless Steel	Étui Carton sur Lame Acier Inoxydable NITRUM®	Coprilama di Cartone Acciaio Inossidabile NITRUM®	Capa de Cartão Aço Inoxidável NITRUM®
	Polipropileno Recubierto con Elastómero	Polypropylene Covered by Elastomer	Polypropylène Recouvert d'Élastomère	Polipropilene Ricoperto con Elastomero	Polipropileno Revestido com Elastômero



NEW

202000

180mm / 7"
313mm / 12,3"

Cuchillo Carnicero // Butcher Knife // Couteau à Parer // Coltello Macellaio // Faca de Carniceiro



NEW

202100

200mm / 8"
333mm / 13,1"

Cuchillo Carnicero // Butcher Knife // Couteau à Parer // Coltello Macellaio // Faca de Carniceiro



NEW

202200

200mm / 8"
333mm / 13,1"

Cuchillo Carnicero Curvo // Curved Butcher Knife // Couteau à Parer Courbé // Coltello Macellaio Curvo // Faca de Carniceiro Curvada



NEW

202300

220mm / 8"
370mm / 14,5"

Cuchillo Carnicero Curvo // Curved Butcher Knife // Couteau à Parer Droit // Coltello Macellaio Curvo // Faca de Carniceiro Curvada

	Funda Cartón Hoja Acero Inoxidable Nitrum®	Cardboard Sheath NITRUM® Stainless Steel	Étui Carton sur Lame Acier Inoxydable NITRUM®	Coprilama di Cartone Acciaio Inossidabile NITRUM®	Capa de Cartão Aço Inoxidável NITRUM®
	Polipropileno Recubierto con Elastómero	Polypropylene Covered by Elastomer	Polypropylène Recouvert d'Élastomère	Polipropilene Ricoperto con Elastomero	Polipropileno Revestido com Elastómero



NEW

202400

220mm / 8"
380mm / 14,9"

Cuchillo Carnicero Curvo // Curved
Butcher Knife // Couteau à Parer
Courbé // Coltello Macellaio Curvo
Faca de Carniceiro Curvada



NEW

202500

250mm / 10"
400mm / 15,7"

Cuchillo Carnicero Recto // Recta
Butcher Knife // Couteau à Parer
Droit // Coltello Macellaio Retto
Faca de Carniceiro Reta



NEW

202600

250mm / 10"
410mm / 16,1"



Cuchillo Carnicero Curvo // Curved
Butcher Knife // Couteau Boucher
Courbé // Coltello Macellaio Curvo
Faca de Carniceiro Curvada



PROFESSIONAL POCKET KNIVES
COUTEAUX DE POCHE PROFESIONNELS
COLTELLO DA TASCA
FAÇA PROFISSIONAIS

NAVAJAS PROFESIONNALES



	Caja	Box	Boîte	Scatola	Caixa
	Acero Inoxidable forjado Nitrum® Polipropileno (PP)	NITRUM® Stainless Steel Polypropylene (PP)	Acier Inoxydable NITRUM® Polypropylène (PP)	Acciaio Inossidabile NITRUM® Polipropilene (PP)	Aço Inoxidável NITRUM® Polipropileno (PP)



485300



Navaja // Pocket Knife // Couteau
Poche // Coltello da Tasca
Navalha



485329

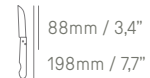

Navaja // Pocket Knife // Couteau
Poche // Coltello da Tasca
Navalha



485700



Navaja // Pocket Knife // Couteau
Poche // Coltello da Tasca
Navalha



485729



Navaja // Pocket Knife // Couteau
Poche // Coltello da Tasca
Navalha



485900

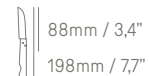

Navaja // Pocket Knife // Couteau
Poche // Coltello da Tasca
Navalha



485929

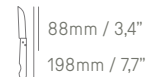

Navaja // Pocket Knife // Couteau
Poche // Coltello da Tasca
Navalha

STEAK KNIVES
COUTEAUX STEAK
COLTELLI BISTECCA
FACA DE CHURRASCO

CHULETEROS



THE ORIGIN

PÁG 155



STEEL-FORCE

PÁG 159



FOREST

PÁG 165



STEAK BASIC

PÁG 172





SERIE THE ORIGIN

El sello de nuestros orígenes en un diseño exclusivo estilo navaja. Elegancia, diseño y funcionalidad en cada pieza. Serie ideal para aportar distinción a cualquier mesa con estilo con un filo liso para cortes precisos.

The hallmark of our origins is an exclusive pocketknife style. Elegance, design and practicality in each piece. Ideal series to add distinction to any table with style, which has a smooth edge for precise cuts.

L'authenticité de nos origines capturée dans un design exclusif, rappelant la forme des couteaux typiquement espagnols. Élégance, conception et fonctionnalité se retrouvent dans chaque pièce. Une collection idéale pour apporter une touche distinctive à toute table, avec un tranchant lisse pour des coupes précises.

La caratteristica delle nostre origini è un design esclusivo, che ricorda il coltello a serramanico. Eleganza, design e funzionalità in ogni pezzo. Serie ideale per donare raffinatezza e stile a ogni tavola, grazie a un filo dritto per tagli precisi.

O selo das nossas origens num design exclusivo ao estilo de navalha. Elegância, design e funcionalidade em cada peça. A série ideal para dar distinção a qualquer mesa elegante, com um fio liso para cortes precisos.



Acero Inoxidable

Stainless Steel · Acier Inoxydable · Acciaio Inossidabile
Aço Inoxidável.

Filo Liso

Smooth Edge · Lame Lisse · Bordo Liscio · Borda Lisa.

Diseño Estilo NAVAJA

Pocket knife-Style Design · Design Style Couteau de Poche · Design Stile Coltello Tascabile · Design Estilo Navalha

Resistente a la Corrosión

Corrosion-Resistant · Résistant à la Corrosion
Resistente alla Corrosione · Resistente à Corrosão.

Remaches de Acero Inox

Stainless Steel Rivets · Rivets en acier inoxydable
Rivetti in Acciaio Inossidabile · Rebites de Aço Inoxidável.

10 Años de Garantía

10-Year Warranty · Garantie 10 Ans · Garanzia 10 Anni
Garantia de 10 Anos.

	Caja	Box	Boîte	Scatola	Caixa
	Acero Inoxidable NITRUM® Madera Palisandro	NITRUM® Stainless Steel Rosewood	Acier Inoxydable NITRUM® Bois Palissandre	Acciaio Inossidabile NITRUM® Legno Palissandro	Aço Inoxidável NITRUM® Madeira de Palisandro



373700

110mm/4,3"
230mm/9"

Chuletero (Filo) // Steak Knife
(Cutting edge) // C. Steak (Lisse)
Coltello Bistecca (Filo) // Faca de
churrasco (Fio)

	Caja	Box	Boîte	Scatola	Caixa
	Acero Inoxidable NITRUM® MICARTA	NITRUM® Stainless Steel MICARTA	Acier Inoxydable NITRUM® MICARTA	Acciaio Inossidabile NITRUM® MICARTA	Aço Inoxidável NITRUM® MICARTA



373723

110mm/4,3"
230mm/9"

Chuletero (Filo) // Steak Knife
(Cutting edge) // C. Steak (Lisse)
Coltello Bistecca (Filo) // Faca de
churrasco (Fio)



373728

110mm/4,3"
230mm/9"

Chuletero (Filo) // Steak Knife
(Cutting edge) // C. Steak (Lisse)
Coltello Bistecca (Filo) // Faca de
churrasco (Fio)

 	Caja	Box	Boîte	Scatola	Caixa
	Acero Inoxidable 18/10 Madera Palisandro	Stainless Steel 18/10 Rosewood	Acier Inoxydable 18/10 Bois Palissandre	Acier Inoxydable 18/10 Palissandro	Aço Inoxidável 18/10 Madeira de Palisandro



373900

 90mm/3,5"
 220mm/8,6"

Tenedor Mesa // Table Fork
Fourchette Table // Forchetta
Tavola // Garfo Mesa

 	Caja	Box	Boîte	Scatola	Caixa
	Acero Inoxidable 18/10 MICARTA	Stainless Steel 18/10 MICARTA	Acier Inoxydable 18/10 MICARTA	Acier Inoxydable 18/10 MICARTA	Aço Inoxidável 18/10 MICARTA



373923

 90mm/3,5"
 220mm/8,6"

Tenedor Mesa // Table Fork
Fourchette Table // Forchetta
Tavola // Garfo Mesa



373928

 90mm/3,5"
 220mm/8,6"

Tenedor Mesa // Table Fork
Fourchette Table // Forchetta
Tavola // Garfo Mesa

	Caja	Box	Boîte	Scatola	Caixa
	Acero Inoxidable NITRUM® Madera Palisandro	NITRUM® Stainless Steel Rosewood	Acier Inoxydable NITRUM® Palissandre	Acciaio Inossidabile NITRUM® Legno Palissandro	Aço Inoxidável NITRUM® Madeira de Palissandro



4 X 373700



807000

Set Chuleteros 4 piezas // 4pc. Steak Set
Set Steak 4 pc. // Set Steak 4 Pezzi
Conjunto 4 Peças

	Caja	Box	Boîte	Scatola	Caixa
	Acero Inoxidable NITRUM® MICARTA	NITRUM® Stainless Steel MICARTA	Acier Inoxydable NITRUM® MICARTA	Acciaio Inossidabile NITRUM® MICARTA	Aço Inoxidável NITRUM® MICARTA



4 X 373723



807100

Set Chuleteros 4 piezas // 4pc. Steak Set
Set Steak 4 pc. // Set Steak 4 Pezzi
Conjunto 4 Peças



4 X 373728



807200

Set Chuleteros 4 piezas // 4pc. Steak Set
Set Steak 4 pc. // Set Steak 4 Pezzi
Conjunto 4 Peças



SERIE STEEL FORCE

Fabricados en una sola pieza de acero inoxidable que ofrecen durabilidad y resistencia a la corrosión. Perfectos para uso diario, robustos, esenciales y duraderos para cualquier mesa.

Made in one single piece of stainless steel that is durable and corrosion-resistant. Perfect for daily use, robust, essential and long-lasting for any table.

Fabriqués d'une seule pièce en acier inoxydable, durables et résistants à la corrosion. Parfaits à utiliser au quotidien, robustes, essentiels et durables pour n'importe quelle table.

Fabbricati in un unico pezzo di acciaio inossidabile, che fornisce durevolezza e resistenza alla corrosione. Perfetti per l'uso quotidiano, robusti, essenziali e durevoli per ogni tavola.

Fabricadas a partir de uma única peça de aço inoxidável para maior durabilidade e resistência à corrosão. Perfeitas para o uso quotidiano, robustas, essenciais e duradouras para qualquer mesa.



Acero Inoxidable

Stainless steel · Acier Inoxydable · Acciaio Inossidabile
Aço Inoxidável.

Fabricados de una Sola Pieza

Made in one Piece · Fabriqués en une Seule Pièce · Fabbricati
in un Unico Pezzo · Fabricados em uma Única Peça.

Resistente a la Corrosión

Corrosion-Resistant · Résistant à la Corrosion · Resistente
alla Corrosione · Resistente à Corrosão.

10 Años de Garantía

10-Year Warranty · Garantie 10 Ans · Garanzia 10 Anni
Garantia de 10 Anos.

	Caja	Box	Boîte	Scatola	Caixa
	Acero Inoxidable	Stainless Steel	Acier Inoxydable	Acciaio Inossidabile	Aço Inoxidável



375500

110mm/4,3"
220mm/8,6"

Chuletero (Microdentado) // Steak Knife (Micro-Serrated) // Couteau Steak (Microcranté) // Coltello Bistecca (Microdentato) // Faca de churrasco (Micro-Serrilhada)



375800

110mm/4,3"
220mm/8,6"

Chuletero (Microdentado) // Steak Knife (Micro-Serrated) // Couteau Steak (Microcranté) // Coltello Bistecca (Microdentato) // Faca de churrasco (Micro-Serrilhada)



702000

110mm/4,3"
220mm/8,6"

Chuletero (Microdentado) // Steak Knife (Micro-Serrated) // Couteau Steak (Microcranté) // Coltello Bistecca (Microdentato) // Faca de churrasco (Micro-Serrilhada)



376500

110mm/4,3"
220mm/8,6"

Chuletero (Filo) // Steak Knife (Cutting edge) // Couteau Steak (Lisse) // Coltello Bistecca (Filo) // Faca de churrasco (Fio)



701000

110mm/4,3"
220mm/8,6"

Chuletero (Filo) // Steak Knife (Cutting edge) // Couteau Steak (Lisse) // Coltello Bistecca (Filo) // Faca de churrasco (Fio)

	Caja	Box	Boîte	Scatola	Caixa
	Acero Inoxidable	Stainless Steel	Acier Inoxydable	Acciaio Inossidabile	Aço Inoxidável



376900



Chuletero (Filo) // Steak Knife (Cutting edge) // C. Steak (Lisse) Coltello Bistecca (Filo) // Faca de Churrasco (Fio)



375900



Chuletero (Dentado) Steak Knife (Serrated) Couteau Steak (Microdenté) Coltello Bistecca (Dentato) Faca de Churrasco (Serrilhada)



565600



Chuletero (Dentado) Steak Knife (Serrated) Couteau Steak (Microdenté) Coltello Bistecca (Dentato) Faca de Churrasco (Serrilhada)

	Caja	Box	Boîte	Scatola	Caixa
	Acero Inoxidable 18/10	Stainless Steel 18/10	Acier Inoxydable 18/10	Acciaio Inossidabile 18/10	Aço Inoxidável 18/10



702100



Tenedor // Steak Fork // Fourchette Table // Forchetta Bistecca Garfo

	Caja	Box	Boîte	Scatola	Caixa
	Acero Inoxidable 18/10	Stainless Steel 18/10	Acier Inoxydable 18/10	Acciaio Inossidabile 18/10	Aço Inoxidável 18/10



701900

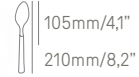

Cuchara // Spoon // Cuillère
Cucchiaione // Colher



701800



Cuchara Lunch // Lunch Spoon
Cuillère Lunch // Cucchiaio Frutta
Colher Lunch

	Caja	Box	Boîte	Scatola	Caixa
	Acero Inoxidable	Stainless Steel	Acier Inoxydable	Acciaio Inossidabile	Aço Inoxidável





4 X 376900



377900

Set Chuleteros 4 piezas // 4pc. Steak
Set // Set 4 Pièces // Set Steak // 4 Pezzi
Conjunto 4 Peças

	Caja	Box	Boîte	Scatola	Caixa
	Acero Inoxidable	Stainless Steel	Acier Inoxydable	Acciaio Inossidabile	Aço Inoxidável



6 X 375500

378000

Set Chuleteros 6 piezas // 6 pc. Steak Set // Set 6 Ctx steak // Set Steak 6 Pezzi Conjunto 6 Peças



6 X 3755 6 X 7021

378100

Set Chuleteros 12 piezas // 12 pc. Steak Set // Set 12 Steak // Set Steak 12 Pezzi Conjunto 12 Peças



6 X 376500

378200

Set Chuleteros 6 piezas // 6 pc. Steak Set // Set 6 Steak // Set Steak 6 // Pezzi Conjunto 6 Peças



4 X 375800

378400

Set Chuleteros 4 piezas // 4 pc. Steak Set // Set 4 Ctx Steak // Set Steak 4 Pezzi Conjunto 4 Peças



6 X 702000

702300

Set Chuleteros 6 piezas // 6 pc. Steak Set // Set 6 Steak // Set Steak 6 // Pezzi Conjunto 6 Peças



4 X 375900

377400

Set Chuleteros 4 piezas // 4 pc. Steak Set // Set 4 ctx Steak // Set Steak 4 // Pezzi Conjunto 4 Peças



ARCOS®
MADE IN ALBACETE-SPAIN



SERIE FOREST

Un toque rústico y de calidez, ideales para quienes buscan durabilidad y estilo tradicional en el uso diario. Su mango de madera natural agrega un encanto atemporal y funcionalidad a la mesa.

A rustic and warm touch. Ideal for anyone who wants durability and a traditional style in daily use. Its natural wood handle adds a classic charm and practicality to the table.

Une touche rustique et chaleureuse, parfaite pour ceux qui privilégient la durabilité et le style traditionnel au quotidien. Son manche en bois naturel apporte un charme intemporel à la table, combinant élégance et praticité.

Un tocco rustico e caloroso. Ideali per chi ricerca la durevolezza e lo stile tradizionale nell'uso quotidiano. Il manico di legno naturale dona alla tavola un fascino senza tempo e funzionalità.

Um toque de rusticidade e calor, ideais para quem procura durabilidade e estilo tradicional no dia a dia. O cabo em madeira natural confere um charme intemporal e funcionalidade à mesa.

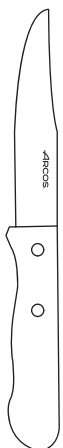

Acero Inoxidable

Stainless Steel · Acier Inoxydable · Acciaio Inossidabile · Aço Inoxidável.

Diseño Rústico

Diseño Rústico · Rustic Design · Design Rustique · Design Rustico · Design Rústico.



MANGO de Madera NATURAL

Natural Wood Handles · Manches en Bois Naturel · Manici in Legno Naturale · Cabos de Madeira Natural.





Remaches de Acero Inox

Stainless Steel Rivets · Rivets en Acier Inoxydable · Rivetti in Acciaio Inossidabile · Rebites de Aço Inoxidável.

10 Años de Garantía

10-Year Warranty · Garantie 10 Ans · Garanzia 10 Anni · Garantia de 10 Anos.

	Caja	Box	Boîte	Scatola	Caixa
	Acero Inoxidable Nitrum® Madera Comprimida	NITRUM® Stainless Steel Pack-Wood	Acier Inoxydable NITRUM® Bois Compressé	Acciaio Inossidabile NITRUM® Legno Compresso	Aço Inoxidável NITRUM® Madeira comprimida



371800



Chuletero Natural (Microdentado)
Natural Steak Knife (Micro-Serrated) // Couteau Steak Naturel (Microcranté) // Coltello Bistecca Naturale (Microdentato) // Faca de Churrasco Natural (Micro-Serrilhada)



371822



Chuletero Natural (Microdentado)
Natural Steak Knife (Micro-Serrated) // Couteau Steak Naturel (Microcranté) // Coltello Bistecca Naturale (Microdentato) // Faca de Churrasco Natural (Micro-Serrilhada)



371823



Chuletero Natural (Microdentado)
Natural Steak Knife (Micro-Serrated) // Couteau Steak Naturel (Microcranté) // Coltello Bistecca Naturale (Microdentato) // Faca de Churrasco Natural (Micro-Serrilhada)

	Caja	Box	Boîte	Scatola	Caixa
	Acero Inoxidable 18/10 Madera Comprimida	Stainless Steel 18/10 Pack-Wood	Acier Inoxydable 18/10 Bois Compressé	Acciaio Inossidabile 18/10 Legno Compresso	Aço Inoxidável 18/10 Madeira comprimida



371900



Tenedor // Steak Fork // Fourchette Table // Forchetta Bistecca
Garfo Mesa



372100



Cuchara Mesa // Table Spoon
Cuillère Table // Cucchiaine Tavola
Colher Mesa



373000





Cuchara Lunch // Lunch Spoon
Cuillère Lunch // Cucchiaino Frutta
Colher Lunch

	Caja	Box	Boîte	Scatola	Caixa
	Acero Inoxidable NITRUM® Madera de Haya	NITRUM® Stainless Steel Beech Wood	Acier Inoxydable NITRUM® Bois de Hêtre	Acciaio Inossidabile NITRUM® Legno di Faggio	Aço Inoxidável NITRUM® Madeira de Faia



374200

 126mm/4,9"
 257mm/10,1"

Cuchillo para Churrasco (Dentado)
Steak Knife (Serrated)
C. Steak Churrasco (Microdenté)
Coltello Bistecca (Dentato)
Faca para Churrasco (Serrilhada)

	Caja	Box	Boîte	Scatola	Caixa
	Acero Inoxidable NITRUM® Madera Comprimida	NITRUM® Stainless Steel Pack-Wood	Acier Inoxydable NITRUM® Bois Compressé	Acciaio Inossidabile NITRUM® Legno Compresso	Aço Inoxidável NITRUM® Madeira CTomprimida





372500

 110mm/4,3"
 220mm/8,6"



Chuletero (Microdentado)
Steak Knife (Micro-Serrated)
Couteau Steak (Microcranté)
Coltello Bistecca (Microdentato)
Faca de Churrasco (Micro-Serrilhada)



372700

 120mm/4,7"
 235mm/9,2"

Chuletero (Microdentado)
Steak Knife (Micro-Serrated)
Couteau Steak (Microcranté)
Coltello Bistecca (Microdentato)
Faca de Churrasco (Micro-Serrilhada)



	Caja	Box	Boîte	Scatola	Caixa
	Acero Inoxidable 18/10 Madera Comprimida	Stainless Steel 18/10 Pack-Wood	Acier Inoxydable 18/10 Bois Compressé	Acciaio Inossidabile 18/10 Legno Compresso	Aço Inoxidável 18/10 Madeira Comprimida



372600



Tenedor // Steak Fork // Fourchette
Steak // Forchetta Bistecca
Garfo Mesa



	Caja	Box	Boîte	Scatola	Caixa
	Acero Inoxidable NITRUM® Madera Comprimida	NITRUM® Stainless Steel Pack-Wood	Acier Inoxydable NITRUM® Bois Compressé	Acciaio Inossidabile NITRUM® Legno Compresso	Aço Inoxidável NITRUM® Madeira Comprimida



803800



Chuletero (Microdentado)
Steak Knife (Micro-Serrated)
Couteau Steak (Microcranté)
Coltello Bistecca (Microdentato)
Faca de Churrasco (Micro-Serrilhada)

	Caja	Box	Boîte	Scatola	Caixa
	Acero Inoxidable NITRUM® Madera Comprimida	NITRUM® Stainless Steel Pack-Wood	Acier Inoxydable NITRUM® Bois Compressé	Acciaio Inossidabile NITRUM® Legno Compresso	Aço Inoxidável NITRUM® Madeira comprimida



374610



Chuletero-Macheta (filo)
Steak Knife Cleaver (Cutting Edge)
C. à steak-couperet (Lisse)
Coltello Bistecca-Mannaietta
(Filo) // Faca de Churrasco (Fio)

	Caja	Box	Boîte	Scatola	Caixa
	Acero Inoxidable NITRUM® Madera Comprimida	NITRUM® Stainless Steel Pack-Wood	Acier Inoxydable NITRUM® Bois Compressé	Acciaio Inossidabile NITRUM® Legno Compresso	Aço Inoxidável NITRUM® Madeira comprimida



6 X 3718



372300

Set Chuleteros 6 piezas // 6 pc. Steak Set// Set 6 C. Steak // Set Steak 6 Pezzi
Conjunto 6 Peças



6 X 371823



830400

Set Chuleteros 6 piezas // 6 pc. Steak Set
Set 6 C. Steak // Set Steak 6 Pezzi
Conjunto 6 Peças





6 X 371822



377100

Set Chuleteros 6 piezas // 6 pc. Steak Set
Set 6 C. Steak // Set Steak 6 Pezzi
Conjunto 6 Peças

 	<p>Caja Regalo</p> <p>Acero Inoxidable NITRUM® Acero Inoxidable 18/10 Madera de Chopo Comprimida</p>	<p>Gift Box</p> <p>NITRUM® Stainless Steel Acero Inoxidable 18/10 Pack-Wood</p>	<p>Boîte Cadeau</p> <p>Acier Inoxydable NITRUM® Acier Inoxydable 18/10 Bois Compressé</p>	<p>Scatola Regalo</p> <p>Acciaio Inossidabile NITRUM® Acier Inoxydable 18/10 Legno Compresso</p>	<p>Caixa de Presente</p> <p>Aço Inoxidável NITRUM® Aço Inoxidável 18/10 Madeira de Choupo Comprimida</p>
--	--	---	---	--	--



6 X 3718



6 X 3719



372200

Set Chuleteros 12 piezas // 12 pc. Steak
 Set // Set 12 pc. Steak // Set Steak 12
 Pezzi // Conjunto 12 Peças





SERIE STEAK BASIC

Variedad para cada ocasión con diseños que se adaptan a cualquier preferencia, ideales para diferentes estilos de mesa. Con mangos duraderos y resistentes al agua, garantiza un agarre cómodo.

Variety for each occasion with designs that adapt to any preference, ideal for different table styles. With durable and water-resistant handles that guarantee a comfortable grip.

De la variété pour toutes les occasions avec des designs adaptés à toutes les préférences, parfait pour différents styles de tables. Avec des manches durables et résistants à l'eau, il assure une prise en main confortable.

Varietà per ogni occasione, grazie a design che si adattano a qualsiasi preferenza, ideali per diversi stili di tavola. Manici durevoli e resistenti all'acqua, che garantiscono una presa comoda.

Variedade para todas as ocasiões com designs que se adaptam a todas as preferências, ideais para diferentes estilos de mesa. Com cabos duráveis e resistentes à água, garante uma pega confortável.

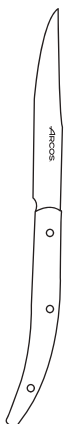

Acero Inoxidable

Stainless Steel · Acier Inoxydable · Acciaio Inossidabile · Aço Inoxidável.

Materiales Resistentes

Resistant Materials · Matériaux résistants · Materiali Resistenti · Materiais Resistentes.

Agarre Cómodo



Comfortable Grip · Prise Confortable · Impugnatura Comoda Pegada Confortável.

Resistente a la Corrosión

Corrosion Resistant · Résistants à la Corrosion · Resistenti alla Corrosione · Resistentes à Corrosão.

10 Años de Garantía

10-Year Warranty · Garantie 10 Ans · Garanzia 10 Anni
Garantia de 10 Anos.



	Caja	Box	Boîte	Scatola	Caixa
	Acero Inoxidable NITRUM® Poliamidas	NITRUM® Stainless Steel Polyamides	Acier Inoxydable NITRUM® Polyamides	Acciaio Inossidabile NITRUM® Poliammidi	Aço Inoxidável NITRUM® Poliamidas



372400

 110mm/4,3"
230mm/9"

Chuletero (Dentado) // Steak Knife (Serrated) // Couteau Steak (Denté) Coltello Bistecca (Dentato) // Faca de Churrasco (Serrilhada)



	Caja	Box	Boîte	Scatola	Caixa
	Acero Inoxidable Nitrum® Polioximetileno (POM)	NITRUM® Stainless Steel Polyoxymethylene (POM)	Acier Inoxydable NITRUM® Polyoxyméthylène (POM)	Acciaio Inossidabile NITRUM® Polioximetilene (POM)	Aço Inoxidável NITRUM® Polioximetileno (POM)



375200

 120mm/4,7"
217mm/8,5"

Chuletero (Dentado) // Steak Knife (Serrated) // Couteau Steak (Denté) Coltello Bistecca (Dentato) // Faca de Churrasco (Serrilhada)



	Caja	Box	Boîte	Scatola	Caixa
	Acero Inoxidable Nitrum® Polioximetileno (POM)	NITRUM® Stainless Steel Polyoxymethylene (POM)	Acier Inoxydable NITRUM® Polyoxyméthylène (POM)	Acciaio Inossidabile NITRUM® Polioximetilene (POM)	Aço Inoxidável NITRUM® Polioximetileno (POM)



374800

 115mm/4,5"
220mm/8,6"

Chuletero (Microdentado) // Steak Knife (Micro-Serrated) // Couteau Steak (Microcranté) // Coltello Bistecca (Microdentato) // Faca de Churrasco (Micro-Serrilhada)



	Caja	Box	Boîte	Scatola	Caixa
	Acero Inoxidable 18/10 Polioximetileno (POM)	Stainless Steel 18/10 Polyoxymethylene (POM)	Acier Inoxydable 18/10 Polyoxyméthylène (POM)	Acciaio Inossidabile 18/10 Polioximetilene (POM)	Aço Inoxidável 18/10 Polioximetileno (POM)



374700

 90mm/3,5"
195mm/7,6"

Tenedor // Steak Fork // Fourchette Table // Forchetta Bistecca Garfo



	Caja	Box	Boîte	Scatola	Caixa
	Acero Inoxidable NITRUM® Polioximetileno (POM) + Latón	NITRUM® Stainless Steel Polyoxymethylene (POM) + Brass	Acier Inoxydable NITRUM® Polyoxyméthylène (POM) + Laiton	Acciaio Inossidabile NITRUM® Polioximetilene (POM) + Ottone	Aço Inoxidável NITRUM® Polioximetileno (POM) + Latão



375000



Chuletero (Microdentado) // Steak Knife (Micro-Serrated) // Couteau Steak (Microcranté) // Coltello Bistecca (Microdentato) // Faca de Churrasco (Micro-Serrilhada)



	Caja	Box	Boîte	Scatola	Caixa
	Acero Inoxidable 18/10 Polioximetileno (POM) + Latón	Stainless Steel 18/10 Polyoxymethylene (POM) + Brass	Acier Inoxydable 18/10 Polyoxyméthylène (POM) + Laiton	Acciaio Inossidabile 18/10 Polioximetilene e (POM) + Ottone	Aço Inoxidável 18/10 Polioximetileno (POM) + Latão



375100



Tenedor // Steak Fork // Fourchette Table // Forchetta Bistecca Garfo Mesa

	Caja	Box	Boîte	Scatola	Caixa
	Acero Inoxidable NITRUM® Polipropileno	NITRUM® Stainless Steel Polypropylene	Acier Inoxydable NITRUM® Polypropylène	Acciaio Inossidabile NITRUM® Polipropilene	Aço Inoxidável NITRUM® Polipropileno



803000





Chuletero (Microdentado) // Steak Knife (Micro-Serrated) // Couteau Steak (Microcranté) // Coltello Bistecca (Microdentato) // Faca de Churrasco (Micro-Serrilhada)



740009



Chuletero (Microdentado) // Steak Knife (Micro-Serrated) // Couteau Steak (Microcranté) // Coltello Bistecca (Microdentato) // Faca de Churrasco (Micro-Serrilhada)

	Caja	Box	Boîte	Scatola	Caixa
	Acero Inoxidable NITRUM® Poliamidas	NITRUM® Stainless Steel Polyamides	Acier Inoxydable NITRUM® Polyamides	Acciaio Inossidabile NITRUM® Poliammidi	Aço Inoxidável NITRUM® Poliamidas



804000

 110mm/4,3"
220mm/8,6"

Chuletero (Microdentado) // Steak Knife (Micro-Serrated) // Couteau Steak (Microcranté) // Coltello Bistecca (Microdentato) // Faca de Churrasco (Micro-Serrilhada)



	Caja	Box	Boîte	Scatola	Caixa
	Acero Inoxidable 18/10 Poliamidas	Stainless Steel 18/10 Polyamides	Acier Inoxydable 18/10 Polyamides	Acciaio Inossidabile 18/10 Poliammidi	Aço Inoxidável 18/10 Poliamidas



804100

 90mm/3,5"
200mm/7,8"

Tenedor // Steak Fork // Fourchette Table // Forchetta Bistecca Garfo

	Caja	Box	Boîte	Scatola	Caixa
	Acero Inoxidable NITRUM® Polipropileno	NITRUM® Stainless Steel Polypropylene	Acier Inoxydable NITRUM® Polypropylène	Acciaio Inossidabile NITRUM® Polipropilene	Aço Inoxidável NITRUM® Polipropileno



805109

 110mm/4,3"
220mm/8,6"

Chuletero (Microdentado) // Steak Knife (Micro-Serrated) // Couteau Steak (Microcranté) // Coltello Bistecca (Microdentato) // Faca de Churrasco (Micro-Serrilhada)

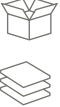
	<p>Caja</p> <p>Acero Inoxidable NITRUM® Polipropileno</p>	<p>Box</p> <p>NITRUM® Stainless Steel Polypropylene</p>	<p>Boîte</p> <p>Acier Inoxydable NITRUM® Polypropylène</p>	<p>Scatola</p> <p>Acciaio Inossidabile NITRUM® Polipropilene</p>	<p>Caixa</p> <p>Aço Inoxidável NITRUM® Polipropileno</p>
---	---	---	--	--	--



4 X 373371



830600

Juego Chuleteros (Filo) 4 piezas // Set 4 Pc. // C. Steak (Lisse) // Set 4 Steak (Lisse) // Set Steak 4 Pezzi // Conjunto 4 Peças (Fio)



4 X 373372



830700

Juego Chuleteros (Filo) 4 piezas // Set 4 pc. // C. Steak (Lisse) // Set 4 Steak (Lisse) // Set Steak 4 Pezzi // Conjunto 4 Peças (Fio)



4 X 373373



830800

Juego Chuleteros (Filo) 4 piezas // Set 4 pc. // C. Steak (Lisse) // Set 4 Steak (Lisse) // Set Steak 4 Pezzi // Conjunto 4 Peças (Fio)

CUCHILLOS DE MESA



TABLE KNIVES
COUTEAUX DE TABLE
COLTELLI DA TABOLA
FACAS DE MESA



FLYSCH

PÁG 179



STEEL-TABLE

PÁG 181



TABLE BASIC

PÁG 183



PIANO CLASSIC

PÁG 185





SERIE FLYSCH

Un cuchillo distintivo con mango que captura la esencia de las formaciones geológicas atlánticas, ideal para mesas que valoran la precisión y la estética natural.

A distinctive knife with a handle that captures the essence of the Atlantic geological formations, ideal for tables that value precision and natural aesthetics.

Un couteau distinctif avec un manche qui capture l'essence des formations géologiques de l'Atlantique, idéal pour les tables qui apprécient la précision et l'esthétique naturelle.

Un coltello caratteristico, con un manico che cattura l'essenza delle formazioni geologiche atlantiche, ideale per tavole che apprezzano la precisione e l'estetica naturale.

Uma faca distintiva com um cabo que capta a essência das formações geológicas atlânticas, ideal para mesas que valorizam a precisão e a estética natural.



Acero Inoxidable NITRUM®

NITRUM® Stainless Steel · Acier Inoxydable NITRUM® · Acciaio Inossidabile NITRUM® · Aço Inoxidável NITRUM®.

Dentado

Serrated · Denté · Dentato · Serrilhada.

Brillo Espejo

Mirror Finish · Polissage Miroir · Lucentezza Specchio · Brilho Espelho.

Gran Poder de Corte

Great Cutting power · Grand Pouvoir de Coupe · Grande Potere di Taglio · Grande Poder de Corte.

Remaches de Latón

Brass Rivets · Rivets en Laiton · Rivetti in Ottone · Rebites de Latão.

10 Años de Garantía

10-Year Warranty · Garantie 10 Ans · Garanzia 10 Anni · Garantia de 10 Anos.



	Caja	Box	Boîte	Scatola	Estojot
	Acero Inoxidable NITRUM® ACRÍLICO (PMMA)	NITRUM® Stainless Steel ACRYLIC (PMMA)	Acier Inoxydable NITRUM® ACRYLIQUE (PMMA)	Acciaio Inossidabile NITRUM® ACRILICO (PMMA)	Aço Inoxidável NITRUM® ACRÍLICO (PMMA)



373800

110mm/4,3"
230mm/9"

Cuchillo Mesa (Dentado) // Table
Knife (Serrated) // Couteau Table
(Denté) // Coltello Tavola (Dentato)
Faca Mesa (Serrilhada)

	Estuche	Case	Étui	Astuccio	Estojo
	Acero Inoxidable NITRUM® Polimetil Metacrilato (PMMA)	NITRUM® Stainless Steel Polymethyl Methacrylate (PMMA)	Acier Inoxydable NITRUM® Polyméthacrylate de Méthyle	Acciaio Inossidabile NITRUM® Polimetil Metacrilato (PMMA)	Aço Inoxidável NITRUM® Polimetil Metacrilato (PMMA)

374000

Juego 4 Cuchillos de Mesa // 4 pc. Table
Knife Set // Set 4 Couteaux de Table
Set 4 Coltelli da Tavola // Jogo 4 Facas
de Mesa



4 X 373800





STEEL-TABLE

Variedad para cada ocasión con diseños que se adaptan a cualquier preferencia, ideales para diferentes estilos de mesa. Con mangos duraderos y resistentes al agua, garantiza un agarre cómodo.

Variety for each occasion with designs that adapt to any preference, ideal for different table styles. With durable and water-resistant handles that guarantee a comfortable grip.

De la variété pour toutes les occasions avec des designs adaptés à toutes les préférences, parfait pour différents styles de tables. Avec des manches durables et résistants à l'eau, il assure une prise en main confortable.

Varietà per ogni occasione, grazie a design che si adattano a qualsiasi preferenza, ideali per diversi stili di tavola.

Manici durevoli e resistenti all'acqua, che garantiscono una presa comoda. Variedade para todas as ocasiões com designs que se adaptam a todas as preferências, ideais para diferentes estilos de mesa. Com cabos duráveis e resistentes à água, garante uma pega confortável.



Acero Inoxidable

Stainless Steel · Acier Inoxydable · Acciaio Inossidabile Aço Inoxidável.

Fabricados de una Sola Pieza

Made in One Piece · Fabriqué en une Seule Pièce · Fabbricati in un Unico Pezzo · Fabricados em uma Única Peça.

No Necesita Afilado

No Need for Sharpening · Ne nécessite pas D'Affûtage · Non Necessita di affilatura · Não Precisa de Afição.

Diseño Clásico

Classic design · Design Classique · Design classico · Design Clássico.

10 Años de Garantía

10-Year Warranty · Garantie 10 Ans · Garanzia 10 Anni
Garantia de 10 Anos.

	Caja	Box	Boîte	Scatola	Caixa
	Acero Inoxidable	Stainless Steel	Acier Inoxydable	Acciaio Inossidabile	Aço Inoxidável



460100

110mm/4,3"
200mm/7,8"

Cuchillo Postre (Microdentado)
Dessert Knife (Micro-Serrated)
Couteau Dessert (Microcranté)
Coltello Frutta (Microdentato)
Faca Sobremesa (Micro-Serrilhada)



460400

125mm/4,9"
225mm/8,8"

Cuchillo Mesa (Microdentado)
Table Knife (Micro-Serrated)
Couteau Table (Microcranté)
Coltello Tavola (Microdentato)
Faca Mesa (Micro-Serrilhada)



SERIE TABLE BASIC

La unión perfecta de ligereza y durabilidad, esenciales de uso diario que aportan tradición artesanal y practicidad a tu cubertería.

The perfect blend of lightness and durability, essential for daily use that provides your cutlery with artisan tradition and practicality.

La combinaison parfaite de légèreté et de durabilité, essentielles dans une utilisation quotidienne, apportant de la tradition artisanale et du pratique à vos couverts.

La perfetta unione di leggerezza e durevolezza, imprescindibili di uso quotidiano che apportano tradizione artigianale e praticità alla vostra posateria.

A união perfeita entre leveza e durabilidade, essenciais para o quotidiano, que trazem o artesanato tradicional e a praticidade à sua cutelaria.



Acero Inoxidable NITRUM®

NITRUM® Stainless Steel · Acier Inoxydable NITRUM® · Acciaio Inossidabile NITRUM® · Aço Inoxidável NITRUM®.

Materiales Resistentes

Resistant Materials · Matériaux Résistants · Materiali Resistenti · Materiais Resistentes.

Agarre Cómodo

Comfortable Grip · Prise Confortable · Impugnatura Comoda · Pegada Confortável.



Plásticos Técnicos (PP)



Technical Plastics (Polipropileno) · Plastiques Techniques (Polypropylene) · Plastiche Tecniche (Polypropylène) · Plásticos Técnicos (Polipropilene)

10 Años de Garantía

10-Year Warranty · Garantie 10 Ans · Garanzia 10 Anni · Garantia de 10 Anos.

Diseño Ligero

Light Weight Design · Conception Légère · Design Leggero · Design Leve.

	Caja	Box	Boîte	Scatola	Caixa
	Acero Inoxidable NITRUM® Polipropileno (PP)	NITRUM® Stainless Steel Polypropylene (PP)	Acier Inoxydable NITRUM® Polypropylène (PP)	Acciaio Inossidabile NITRUM® Polipropilene (PP)	Aço Inoxidável NITRUM® Polipropileno (PP)



370100

 105mm/4,1"
 205mm/8"

Cuchillo Postre (Microdentado)
Dessert Knife (Micro-Serrated)
Couteau Dessert (Microcranté)
Coltello Frutta (Microdentato)
Faca Sobremesa (Micro-Serrilhada)



370200

 125mm/4,9"
 230mm/9"

Cuchillo Mesa (Microdentado)
Table Knife (Micro-Serrated)
Couteau Table (Microcranté)
Coltello Tavola (Microdentato)
Faca Mesa (Micro-Serrilhada)



802900

 110mm/4,3"
 210mm/8,2"

Cuchillo Mesa (Microdentado)
Table Knife (Micro-Serrated)
Couteau Table (Microcranté)
Coltello Tavola (Microdentato)
Faca Mesa (Micro-Serrilhada)



802910

 110mm/4,3"
 210mm/8,2"

Cuchillo Mesa (Microdentado)
Table Knife (Micro-Serrated)
Couteau Table (Microcranté)
Coltello Tavola (Microdentato)
Faca Mesa (Micro-Serrilhada)



SERIE PIANO CLASSIC

Funcionalidad cotidiana: resistente, con un diseño de vanguardia. Sus cuchillos no requieren afilado frecuente, asegurando un corte perfecto con cada uso gracias a su duradero filo perlado.

Everyday practicality: strong, with a state-of-the-art design. Frequent sharpening is not required for these knives, a perfect cut is guaranteed whenever they are used thanks to the long-lasting pearled edge of the blade.

Fonctionnalité au quotidien : robuste, avec un design avant-gardiste. Ses couteaux ne nécessitent pas d'affûtage fréquent, assurant une découpe parfaite à chaque utilisation grâce à leur tranchant cranté durable.

Funcionalità quotidiana: resistente e dal design d'avanguardia. Questi coltelli non richiedono affilature frequenti e garantiscono un taglio perfetto ad ogni utilizzo, grazie al loro durevole filo perlato.

Funcionalidade quotidiana: resistente, com um design de vanguardia. As suas facas não necessitam de ser afiadas com frequência, garantindo um corte perfeito em cada utilização graças ao seu perolado de longa duração.



Acero Inoxidable

Stainless Steel · Acier Inoxydable · Acciaio Inossidabile
Aço Inoxidável.

Diseño Clásico

Classic Design · Design Classique · Design Classico · Design Clássico.

Materiales Resistentes

Resistant Materials · Matériaux Résistants · Materiali Resistenti · Materiais Resistentes.

No Necesita Afilado

No Need for Sharpening · Ne nécessite Pas D'Affûtage · Non
Necessita di Affilatura · Não Precisa de Afição.

Remaches de Acero Inox

Stainless Steel Rivets · Rivets en Acier Inoxydable · Rivetti in
Acciaio Inossidabile · Rebites de Aço Inoxidável.

10 Años de Garantía

10-Year Warranty · Garantie 10 Ans · Garanzia 10 Anni
Garantia de 10 Anos.

	Caja	Box	Boîte	Scatola	Caixa
	Acero Inoxidable NITRUM® Poliamidas	NITRUM® Stainless Steel Polyamides	Acier Inoxydable NITRUM® Polyamides	Acciaio Inossidabile NITRUM® Poliammidi	Aço Inoxidável NITRUM® Poliamidas



370600

110mm/4,3"
195mm/7,6"

Cuchillo Postre (Microdentado)
Dessert Knife (Micro-Serrated)
Couteau Dessert (Microcranté)
Coltello Frutta (Microdentato)
Faca Sobre mesa (Micro-Serrilhada)



370000

115mm/4,5"
216mm/8,5"

Cuchillo Mesa (Microdentado)
Table Knife (Micro-Serrated)
Couteau Table (Microcranté)
Coltello Tavola (Microdentato)
Faca Mesa (Micro-Serrilhada)



370625

110mm/4,3"
195mm/7,6"

Cuchillo Postre (Microdentado)
Dessert Knife (Micro-Serrated)
Couteau Dessert (Microcranté)
Coltello Frutta (Microdentato)
Faca Sobre mesa (Micro-Serrilhada)



370025

115mm/4,5"
216mm/8,5"

Cuchillo Mesa (Microdentado)
Table Knife (Micro-Serrated)
Couteau Table (Microcranté)
Coltello Tavola (Microdentato)
Faca Mesa (Micro-Serrilhada)

	Caja	Box	Boîte	Scatola	Caixa
	Acero Inoxidable 18/10 Poliamidas	Stainless Steel 18/10 Polyamides	Acier Inoxydable 18/10 Polyamides	Acciaio Inossidabile 18/10 Poliammidi	Aço Inoxidável 18/10 Poliamidas



370500

100mm/3,9"
195mm/7,6"

Tenedor Mesa // Steak Fork
Fourchette Table // Forchetta
Bistecca // Garfo Mesa



370525

100mm/3,9"
195mm/7,6"

Tenedor Mesa // Steak Fork
Fourchette Table // Forchetta
Bistecca // Garfo Mesa

CUBERTERÍAS



FLATWARE
COUVERTS
POSATERIA
TALHERES





GREGORIO
PÁG 189



CAPRI
PÁG 209



MANCHEGA
PÁG 193



BERLIN
PÁG 215



MILANO
PÁG 197



TOSCANA
PÁG 221



LISBOA
PÁG 201



SERIE GREGORIO

La colección Gregorio Arcos es un homenaje a la tradición culinaria y al diseño atemporal. Inspirada en el icónico cuchillo chuletero modelo 3715, creado por Gregorio Arcos en los años 70, esta serie refleja la artesanía y precisión que distinguen a ARCOS desde siempre.

The Gregorio Arcos collection is a tribute to culinary tradition and timeless design. Inspired by the iconic steak knife model 3715, created by Gregorio Arcos in the 1970s, this series reflects the craftsmanship and precision that have always distinguished ARCOS.

La collection Gregorio Arcos rend hommage à la tradition culinaire et au design intemporel. Inspirée du couteau à steak emblématique modèle 3715, créé par Gregorio Arcos dans les années 70, cette série reflète l'artisanat et la précision qui distinguent ARCOS depuis toujours.

La collezione Gregorio Arcos è un tributo alla tradizione culinaria e al design senza tempo. Ispirata al coltello da bistecca iconico modello 3715, creato da Gregorio Arcos negli anni '70, questa serie riflette l'artigianalità e la precisione che da sempre distinguono ARCOS.

A coleção Gregorio Arcos é uma homenagem à tradição culinária e ao design atemporal. Inspirada na icônica faca de carne modelo 3715, criada por Gregorio Arcos nos anos 70, esta série reflete o artesanato e a precisão que sempre distinguiram a ARCOS.

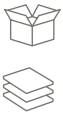
	Caja 371501 Display	Box 371501 Display	Boîte 371501 Carte	Scatola 371501 Display	Caixa 371501 Display
	Acero Inoxidable NITRUM® Madera Comprimida	NITRUM® Stainless Steel Pack-Wood	Acier Inoxydable NITRUM® Bois Compressé	Acciaio Inossidabile NITRUM® Legno Compresso	Aço Inoxidável NITRUM® Madeira Comprimida



371500 / 371501

 110mm / 4,3"
 220mm / 8,6"

Chuletero (Microdentado)
 Steak Knife (Micro-Serrated)
 Couteau Steak (Microcranté)
 Coltello Bistecca (Microdentato)
 Faca de Churrasco (Micro-Serrilhada)



373200

 110mm / 4,3"
 220mm / 8,6"

Chuletero (Filo) // Steak Knife
 (Cutting edge) // C. Steak (Lisse)
 Coltello Bistecca (Filo) // Faca de churrasco (Fio)

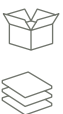
	Caja 371601 Display	Box 371601 Display	Boîte 371601 Carte	Scatola 371601 Display	Caixa 371601 Display
	Acero Inoxidable 18/10 Madera Comprimida	Stainless Steel 18/10 Pack-Wood	Acier Inoxydable 18/10 Bois Compressé	Acciaio Inossidabile 18/10 Legno Compresso	Aço Inoxidável 18/10 Madeira Comprimida



371700

 100mm / 3,9"
 206mm / 8,1"

Cuchara Mesa // Table Spoon
 Cuillère Table // Cucchiaina Tavola
 Colher Mesa



371400

 75mm / 2,9"
 155mm / 6,1"



Cuchara Postre // Dessert Spoon
 Cuillère Dessert // Cucchiaio
 Frutta // Colher Sobremesa







371600/371601

 100mm / 3,9"
 208mm / 8,1"

Tenedor Mesa // Table Fork
 Fourchette Table // Forchetta
 Tavola // Garfo Mesa

	Estuche	Gift Case	Ménagère	Confezione Regalo	Caixa de Presente
	371500 Acero Inoxidable NITRUM® 371700, 371600, 371400 Acero Inoxidable 18/10 Madera Comprimida	371500 NITRUM® Stainless Steel 371700, 371600, 371400 Stainless Steel 18/10 Pack-Wood	371500 Acier Inoxydable NITRUM® 371700, 371600, 371400 Acier Inoxydable 18/10 Bois Compressé	371500 Acciaio Inossidabile NITRUM® 371700, 371600, 371400 Acciaio Inossidabile 18/10 Legno Compresso	371500 Acero Inoxidable NITRUM® 371700, 371600, 371400 Aço Inoxidável 18/10 Madeira comprimida

-  4 X 371500
-  4 X 371700
-  4 X 371600
-  4 X 371400



16



NEW

378800

Juego Chuleteros 16 piezas // 16 pc. Steak Set // Set 16 pc. Steak // Set Steak 16 Pezzi // Conjunto 16 Peças

	Caja Regalo	Gift Box	Boîte Cadeau	Scatola Regalo	Caixa de Presente
	Acero Inoxidable NITRUM® Acero Inoxidable 18/10 Madera Comprimida	NITRUM® Stainless Steel Acero Inoxidable 18/10 Pack-Wood	Acier Inoxydable NITRUM® Acier Inoxydable 18/10 Bois Compressé	Acciaio Inossidabile NITRUM® Acier Inoxydable 18/10 Legno Compresso	Aço Inoxidável NITRUM® Aço Inoxidável 18/10 Madeira Comprimida





6 X 3715 6 X 3716



377700

Juego Chuleteros 12 piezas 12 pc. Steak Set // Set 12 pc. Steak // Set Steak 12 Pezzi // Conjunto 12 Peças

	Blister	Blister	Carte	Blister	Blister
	Acero Inoxidable NITRUM® Madera Comprimida	NITRUM® Stainless Steel Pack-Wood	Acier Inoxydable NITRUM® Bois Compressé	Acciaio Inossidabile NITRUM® Legno Compresso	Aço Inoxidável NITRUM® Madeira comprimida





6 X 3715



372000

Set Chuleteros 6 piezas // 6 pc. Steak Set
Set 6 Steak Bois // Set Steak 6 Pezzi
Conjunto 6 Peças

	Caja	Box	Boîte	Scatola	Caixa
	Acero Inoxidable NITRUM® Madera Comprimida	NITRUM® Stainless Steel Pack-Wood	Acier Inoxydable NITRUM® Bois Compressé	Acciaio Inossidabile NITRUM® Legno Compresso	Aço Inoxidável NITRUM® Madeira comprimida



6 X 3715



377600

Set Chuleteros (Microdentado) 6 piezas
6 pc. Steak Set (Micro-Serrated)
Set 6 Couteau Steak (Microcranté)
Set Steak 6 Pezzi (Microdentato)
Conjunto 6 Peças (Micro-Serrilhada)



6 X 373200



377000

Set Chuleteros (Filo) 6 piezas
6 pc. Steak Set (Cutting Edge)
Set 6 Couteau Steak (Lisse)
Set Steak 6 Pezzi (Filo)
Conjunto 6 Peças (Fio)



SERIE MANCHEGA



Cautive en cada bocado con la cubertería Manchega. Un tributo a la mesa moderna con mangos que evocan herencia, diseño que perdura y una calidad que realza su cocina diaria.

Captivate with every bite with the Manchega cutlery. A tribute to the modern table with handles that evoke heritage, a design that endures, and a quality that enhances your everyday cooking.

Régalez-vous à chaque bouchée avec les couverts Manchega. Des manches qui rendent hommage à nos traditions, un design qui dure et une qualité qui réhausse votre cuisine de tous les jours.

Cattura ad ogni morso con la posateria Manchega. Un tributo alla tavola moderna con manici che evocano l'eredità, un design che persiste e una qualità che esalta la tua cucina quotidiana.

Cativa a cada garfada com a talheres Manchega. Uma homenagem à mesa moderna com cabos que evocam herança, design que perdura e uma qualidade que realça a sua cozinha diária.



	Caja	Box	Boîte	Scatola	Caixa
	Acero Inoxidable NITRUM® Madera Comprimida	NITRUM® Stainless Steel Pack-Wood	Acier Inoxydable NITRUM® Bois Compressé	Acciaio Inossidabile NITRUM® Legno Compresso	Aço Inoxidável NITRUM® Madeira Comprimida



479400



Cuchillo Mesa (Microdentado)
Table Knife (Micro-Serrated)
Couteau Table (Microcranté)
Coltello Tavola (Microdentato)
Faca Mesa (Micro-Serrilhada)

	Caja	Box	Boîte	Scatola	Caixa
	Acero Inoxidable 18/10 Madera Comprimida	Stainless Steel 18/10 Pack-Wood	Acier Inoxydable 18/10 Bois Compressé	Acciaio Inossidabile 18/10 Legno Compresso	Aço Inoxidável 18/10 Madeira Comprimida



479200



Cuchara Postre // Dessert Spoon
Cuillère Dessert // Cucchiaio
Frutta // Colher Sobremesa



479500





Cuchara Mesa // Table Spoon
Cuillère Table // Cucchiaio Tavola
Colher Mesa

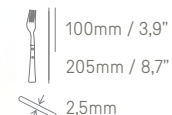

479600



Tenedor Mesa // Table Fork
Fourchette Table // Forchetta
Tavola // Garfo Mesa

 	<p>Estuche</p> <p>479400. Acero Inoxidable NITRUM®</p> <p>479200, 479500, 479600 Acero Inoxidable 18/10</p> <p>Madera Comprimida</p>	<p>Gift Case</p> <p>479400. NITRUM® Stainless Steel</p> <p>479200, 479500, 479600 Stainless Steel 18/10</p> <p>Pack-Wood</p>	<p>Ménagère</p> <p>479400. Acier Inoxydable NITRUM®</p> <p>479200, 479500, 479600. Acier Inoxydable 18/10</p> <p>Bois Compressé</p>	<p>Confezione Regalo</p> <p>479400. Acciaio Inossidabile NITRUM®</p> <p>479200, 479500, 479600 Acciaio Inossidabile 18/10</p> <p>Legno Compresso</p>	<p>Caixa de Presente</p> <p>479400. Acero Inoxidable NITRUM®</p> <p>479200, 479500, 479600 Aço Inoxidável 18/10</p> <p>Madeira comprimida</p>
--	--	--	---	--	---



480100

Estuche 16 Piezas // 16 Pc. Set
 Ménagère 16 Pièces // Confezione 16 Pezzi
 Conjunto 16 Peças

 4 X 479400

 4 X 479500

 4 X 479600

 4 X 479200

16





SERIE MILANO

Con líneas minimalistas y elegantes, ofrece cubiertos sencillos fabricados en una sola pieza de acero inoxidable, perfectos para una estética moderna y sofisticada.

With minimalistic and elegant lines, simple cutlery made in one single piece of stainless steel, perfect to create a sophisticated and modern look.

Avec des lignes minimalistes et élégantes, cette série intègre des couverts simples faits d'une seule pièce d'acier inoxydable, parfaits pour une esthétique moderne et sophistiquée.

Linee minimaliste ed eleganti che si concretizzano in posate semplici, fabbricate in un unico pezzo di acciaio inossidabile, perfette per un'estetica moderna e sofisticata.

Com linhas minimalistas e elegantes, oferece talheres simples feitos numa única peça de aço inoxidável, perfeitos para uma estética moderna e sofisticada.

	Caja	Box	Boîte	Scatola	Caixa
	Acero Inoxidable	Stainless Steel	Acier Inoxydable	Acciaio Inossidabile	Aço Inoxidável



541500

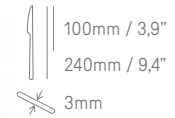

Cuchillo Mesa (Dentado)
 Table Knife (Serrated)
 Couteau Table (Microdenté)
 Coltello Tavola (Dentato)
 Faca Mesa (Serrilhada)

	Caja	Box	Boîte	Scatola	Caixa
	Acero Inoxidable 18/10	Stainless Steel 18/10	Acier Inoxydable 18/10	Acciaio Inossidabile 18/10	Aço Inoxidável 18/10



541300

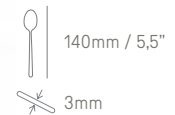

Cuchara Café // Coffee Spoon
 Cuillère Café // Cucchiaino Caffè
 Colher Café



541600

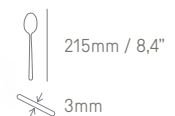

Cuchara Mesa // Table Spoon
 Cuillère Table // Cucchiaino Tavola
 Colher Mesa





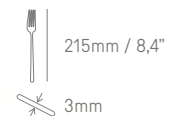

541700



Tenedor Mesa // Table Fork
 Fourchette Table // Forchetta
 Tavola // Garfo Mesa

 	<p>Estuche</p> <p>5415. Acero Inoxidable 5416, 5417, 5413. Acero Inoxidable 18/10</p>	<p>Gift Case</p> <p>5415. Stainless Steel 5416, 5417, 5413. Stainless Steel 18/10T</p>	<p>Ménagère</p> <p>5415. Acier Inoxydable 5416, 5417, 5413. Acier Inoxydable 18/10</p>	<p>Confezione Regalo</p> <p>5415. Acciaio Inossidabile 5416, 5417, 5413. Acciaio Inossidabile 18/10</p>	<p>Caixa de Presente</p> <p>5415. Acero Inoxidable 5416, 5417, 5413. Aço Inoxidável 18/10</p>
--	---	--	--	---	---

-  6 X 5415
-  6 X 5416
-  6 X 5417
-  6 X 5413

24



542000

Estuche 24 Piezas // 24 Pc. Set
Ménagère 24 Pièces // Confezione 24 Pezzi
Conjunto 24 Peças





SERIE LISBOA

Cuartería Lisboa, con su encanto clásico y tradicional, realza cualquier ocasión, ofreciendo un toque de elegancia a la mesa con su diseño atemporal.

Lisboa cutlery, with its classic and traditional charm, enhances any occasion, by providing a touch of elegance to the table with its timeless design.

Les couverts Lisboa, avec leur charme classique et traditionnel, rehaussent toutes les occasions, offrant une touche d'élégance à la table avec leur design intemporel.

La posateria Lisboa, grazie al suo fascino classico e tradizionale, valorizza qualsiasi occasione, giacché il suo design atemporale dona un tocco di eleganza alla tavola.

A cutelaria Lisboa, com o seu charme clássico e tradicional, realça qualquer ocasião, oferecendo um toque de elegância à mesa com o seu design intemporal.

	Caja	Box	Boîte	Scatola	Caixa
	Acero Inoxidable	Stainless Steel	Acier Inoxydable	Acciaio Inossidabile	Aço Inoxidável



595200

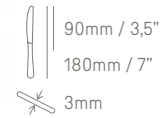

Cuchillo Lunch (Dentado)
 Cake Knife (Serrated)
 Couteau Lunch (Microdenté)
 Coltello Frutta (Dentato)
 Faca Lunch (Serrilhada)



597600



Cuchillo Postre (Dentado)
 Dessert Knife (Serrated)
 Couteau Dessert (Microdenté)
 Coltello Frutta (Dentato)
 Faca Sobremesa (Serrilhada)



596200



Cuchillo Pescado // Fish Knife
 Couteau Poisson // Coltello Pesce
 Faca Peixe



595600



Chuletero (Microdentado)
 Steak Knife (Micro-Serrated)
 Couteau Steak (Microcranté)
 Coltello Bistecca (Microdentato)
 Faca de Churrasco (Micro-Serrilhada)



595900



Cuchillo Mesa (Dentado)
 Table Knife (Serrated)
 Couteau Table (Microdenté)
 Coltello Tavola (Dentato)
 Faca Mesa (Serrilhada)

	Caja	Box	Boîte	Scatola	Caixa
	Acero Inoxidable 18/10	Stainless Steel 18/10	Acier Inoxydable 18/10	Acciaio Inossidabile 18/10	Aço Inoxidável 18/10



595000

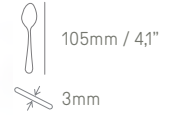

Cuchara Moka // Mocca Spoon
Cuillère Moka // Cucchiaino Moka
Colher Moka



595100

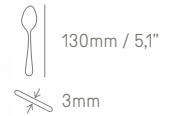

Cuchara Café // Coffee Spoon
Cuillère Café // Cucchiaino Caffè
Colher Café



595500

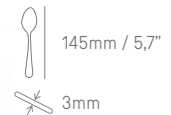

Cuchara Helado // Ice Cream
Spoon // Cuillère Glace // Paletta
Gelato // Colher Gelado



595300



Cuchara Lunch // Cake Spoon
Cuillère Lunch // Cucchiaino Frutta
Colher Lunch



595700

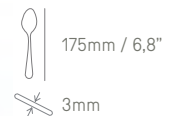

Cuchara Postre // Dessert Spoon
Cuillère Dessert // Cucchiaino
Frutta // Colher Sobremesa



596000

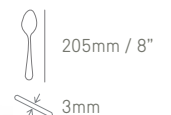

Cuchara Mesa // Table Spoon
Cuillère Table // Cucchiaino Tavola
Colher Mesa

	Caja	Box	Boîte	Scatola	Caixa
	Acero Inoxidable 18/10	Stainless Steel 18/10	Acier Inoxydable 18/10	Acciaio Inossidabile 18/10	Aço Inoxidável 18/10



597100

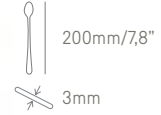

Cuchara Refresco // Ice Tea Spoon
Cuillère à Glace // Cucchiaino Tè
Colher Refresco



597200



Cuchara Ensalada // Salad Spoon
Cuillère Salade // Cucchiaone
Insalata // Colher Ensalada



596800

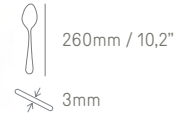

Cuchara Servir // Serving Spoon
Cuillère Service // Cucchiaione
Servire // Colher Servir



596600

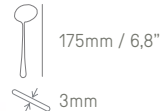

Cacillo Salsa // Gravy Ladle
Louche à Crème // Mestolo Salsa
Concha Molho



597000



Cazo Sopa // Soup Ladle
Louche // Mestolo // Concha Sopa



596900



Pala Pastel // Cake Server
Pelle à Tarte // Pala Torta
Pá Torta

	Caja	Box	Boite	Scatola	Caixa
	Acero Inoxidable 18/10	Stainless Steel 18/10	Acier Inoxydable 18/10	Acciaio Inossidabile 18/10	Aço Inoxidável 18/10



595400

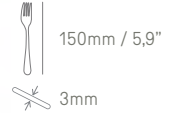

Tenedor Lunch // Cake Fork
 Fourchette Lunch // Forchetta
 Frutta // Garfo Lunch



595800



Tenedor Postre // Dessert Fork
 Fourchette Dessert // Forchettina
 Dolce // Garfo Sobremesa



596300



Tenedor Pescado // Fish Fork
 Fourchette Poisson // Forchettina
 Pesce // Garfo Peixe



596100

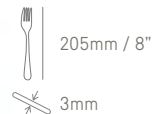

Tenedor Mesa // Table Fork
 Fourchette Table // Forchetta
 Tavola // Garfo Mesa



NEW

596400

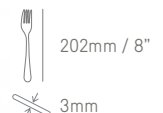

Tenedor Arroz // Rice Fork
 Gargo de arroz // Gargo de Arroz
 Fourchette à Riz // Forchetta Riso

	Caja	Box	Boîte	Scatola	Caixa
	Acero Inoxidable 18/10	Stainless Steel 18/10	Acier Inoxydable 18/10	Acciaio Inossidabile 18/10	Aço Inoxidável 18/10



597300



Tenedor Ensalada // Salad Fork
 Fourchette Salade // Forchettone
 Insalata // Garfo Ensalada



596700



Tenedor Servir // Serving Fork
 Fourchette Service // Forchettone
 Servire // Garfo Servir

	Estuche	Gift Case	Ménagère	Confezione Regalo	Caixa de Presente
	5956. Acero Inoxidable 5951, 5960, 5961. Acero Inoxidable 18/10	5956. Stainless Steel 5951, 5960, 5961. Stainless Steel 18/10	5956. Acier Inoxydable 5951, 5960, 5961. Acier Inoxydable 18/10	5956. Acciaio Inossidabile 5951, 5960, 5961. Acciaio Inossidabile 18/10	5956. Aço Inoxidável 5951, 5960, 5961. Aço Inoxidável 18/10

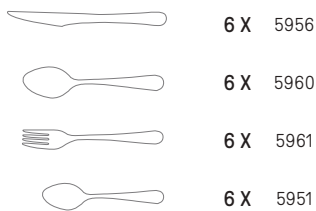

6 X 5956

6 X 5960

6 X 5961

6 X 5951

24



597400

Estuche 24 Piezas // 24 Pc. Set
 Ménagère 24 Pièces // Confezione 24 Pezzi
 Conjunto 24 Peças

 	Maletin 5956, 5952, 5962. Acero Inoxidable	Gift Case 5956, 5952, 5962. Stainless Steel	Ménagère 5956, 5952, 5962. Acier Inoxydable	Astuccio 5956, 5952, 5962. Acciaio Inossidabile	Maleta 5956, 5952, 5962. Aço Inoxidável
	5960, 5961, 5951, 5954, 5950, 5963, 5970, 5968, 5973, 5972, 5962. Acero Inoxidable 18/10	5960, 5961, 5951, 5954, 5950, 5963, 5970, 5968, 5973, 5972, 5962 Stainless Steel 18/10	5960, 5961, 5951, 5954, 5950, 5963, 5970, 5968, 5973, 5972, 5962. Acier Inoxydable 18/10	5960, 5961, 5951, 5954, 5950, 5963, 5970, 5968, 5973, 5972, 5962. Acciaio Inossidabile 18/10	5960, 5961, 5951, 5954, 5950, 5963, 5970, 5968, 5973, 5972, 5962. Aço Inoxidável 18/10

597500

Maletin 113 Piezas // 113 pc. Gift Case
 Ménagère 113 pièces // Astuccio 113 Pezzi
 Conjunto 113 Peças

-  12 X 5956
-  12 X 5960
-  12 X 5961
-  12 X 5952
-  12 X 5951
-  12 X 5954
-  12 X 5950
- 
-  12 X 5962
-  12 X 5963
-  1 X 5970
-  1 X 5968
-  1 X 5973
-  1 X 5972
-  1 X 5969

113







SERIE CAPRI

La serie Capri aporta un diseño innovador a su mesa, combinando modernidad y elegancia, una elección perfecta para espacios que buscan un ambiente contemporáneo.

The Capri series adds an innovative design to your table, by combining modernity and elegance, a perfect choice for places where a contemporary atmosphere is required.

La série Capri apporte un design innovant à votre table, alliant modernité et élégance, un choix parfait pour les espaces à la recherche d'une atmosphère contemporaine.

La serie Capri aporta un design innovatore alla vostra tavola, giacché unisce modernità ed eleganza, una scelta perfetta per spazi che aspirano a creare un ambiente contemporaneo.

A série Capri traz um design inovador para a sua mesa, combinando modernidade e elegância, uma escolha perfeita para espaços que procuram um ambiente contemporâneo.

	Caja	Box	Boîte	Scatola	Caixa
	Acero Inoxidable	Stainless Steel	Acier Inoxydable	Acciaio Inossidabile	Aço Inoxidável



585200

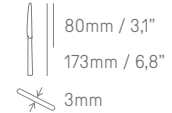

Cuchillo Lunch (Dentado)
 Cake Knife (Serrated)
 Couteau Lunch (Microdenté)
 Coltello Frutta (Dentato)
 Faca Lunch (Serrilhada)



585600



Cuchillo Postre (Dentado)
 Dessert Knife (Serrated)
 Couteau Dessert (Microdenté)
 Coltello Frutta (Dentato)
 Faca Sobremesa (Serrilhada)



586400

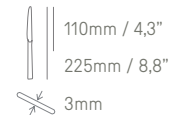

Chuletero (Microdentado)
 Steak Knife (Micro-Serrated)
 Couteau Steak (Microcranté)
 Coltello Bistecca (Microdentato)
 Faca de Churrasco (Micro-Serrilhada)



585900



Cuchillo Mesa (Dentado)
 Table Knife (Serrated)
 Couteau Table (Microdenté)
 Coltello Tavola (Dentato)
 Faca Mesa (Serrilhada)



586200



Cuchillo Pescado // Fish Knife
 Couteau Poisson // Coltello Pesce
 Faca Peixe

	Caja	Box	Boîte	Scatola	Caixa
	Acero Inoxidable 18/10	Stainless Steel 18/10	Acier Inoxydable 18/10	Acciaio Inossidabile 18/10	Aço Inoxidável 18/10



585400

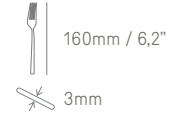

Tenedor Lunch // Cake Fork
Fourchette Lunch // Forchetta
Frutta // Garfo Lunch



585800

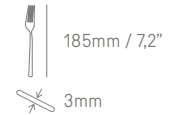

Tenedor Postre // Dessert Fork
Fourchette Dessert // Forchettina
Dolce // Garfo Sobremesa



586300

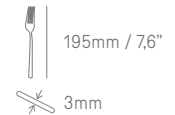

Tenedor Pescado // Fish Fork
Fourchette Poisson // Forchettina
Pesce // Garfo Peixe



586100



Tenedor Mesa // Table Fork
Fourchette Table // Forchetta
Tavola // Garfo Mesa



586700

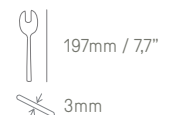

Tenedor Ensalada // Salad Fork
Fourchette Salade // Forchettone
Insalata // Garfo Ensalada

	Caja	Box	Boîte	Scatola	Caixa
	Acero Inoxidable 18/10	Stainless Steel 18/10	Acier Inoxydable 18/10	Acciaio Inossidabile 18/10	Aço Inoxidável 18/10



585000

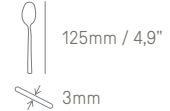

Cuchara Moka // Mocca Spoon
Cuillère Moka //Cucchiaino Moka
Colher Moka



585100

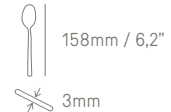

Cuchara Café-Lunch // Coffee-Cake Spoon // Cuillère Café-Lunch
Cucchiaino Caffè-Frutta // Colher Café-lunch



585700

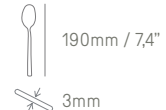

Cuchara Postre // Dessert Spoon
Cuillère Dessert // Cucchiaio Frutta // Colher Sobremesa



586800

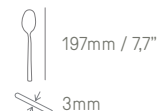

Cuchara Ensalada // Salad Spoon
Cuillère Salade //Cucchiaione Insalata // Colher Ensalada



586000

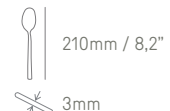

Cuchara Mesa // Table Spoon
Cuillère Table // Cucchiaio Tavola
Colher mesa



586600

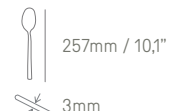

Cuchara Servir // Serving Spoon
Cuillère Service //Cucchiaione Servire // Colher Servir

	Caja	Box	Boîte	Scatola	Caixa
	Acero Inoxidable 18/10	Stainless Steel 18/10	Acier Inoxydable 18/10	Acciaio Inossidabile 18/10	Aço Inoxidável 18/10



587000

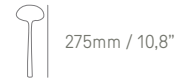

Cazo Sopa // Soup Ladle // Louche
Mestolo // Concha Sopa





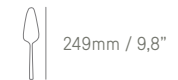

586900



Pala Pastel // Cake Server // Pelle
à Tarte // Pala Torta // Pá Torta

	Estuche	Gift Case	Ménagère	Confezione Regalo	Caixa de Presente
	5859 Acero Inoxidable 5860, 5861, 5851. Acero Inoxidable 18/10	5859 Stainless Steel 5860, 5861, 5851. Stainless Steel 18/10	5859 Acier Inoxydable 5860, 5861, 5851. Acier Inoxydable 18/10	5859 Acciaio Inossidabile 5860, 5861, 5851. Acciaio Inossidabile 18/10	5659 Aço Inoxidável 5860, 5861, 5851. Aço Inoxidável 18/10

	6 X	5859
	6 X	5860
	6 X	5861
	6 X	5851

24



587400

Estuche 24 Piezas // 24 Pc. Set
Ménagère 24 Pièces // Confezione 24 Pezzi
Conjunto 24 Peças

 	Maletin 5859, 5852, 5862 Acero Inoxidable 5860, 5861, 5851, 5854, 5850 5863, 5870, 5866, 5867, 5868, 5869 Acero Inoxidable 18/10	Gift Case 5859, 5852, 5862 Stainless Steel 5860, 5861, 5851, 5854, 5850 5863, 5870, 5866, 5867, 5868, 5869 Stainless Steel 18/10	Ménagère 5859, 5852, 5862 Acier Inoxydable 5860, 5861, 5851, 5854, 5850 5863, 5870, 5866, 5867, 5868, 5869 Acier Inoxydable 18/10	Confezione Regalo 5859, 5852, 5862 Acciaio Inossidabile 5860, 5861, 5851, 5854, 5850 5863, 5870, 5866, 5867, 5868, 5869 Acciaio Inossidabile 18/10	Maleta 5859, 5852, 5862 Aço Inoxidável 5860, 5861, 5851, 5854, 5850 5863, 5870, 5866, 5867, 5868, 5869 Aço Inoxidável 18/10
--	---	---	--	---	--

-  12 X 5859
-  12 X 5860
-  12 X 5861
-  12 X 5852
-  12 X 5851
-  12 X 5854
-  12 X 5850
-  12 X 5862
-  12 X 5863
-  1 X 5870
-  1 X 5866
-  1 X 5867
-  1 X 5868
-  1 X 5869

113



587200

Maletin 113 Piezas // 113 pc. Gift Case
 Ménagère 113 pièces // Confezione 113
 Pezzi // Conjunto 113 Peças





SERIE BERLÍN

La serie Berlín aporta durabilidad y estilo con sus formas ovaladas y diseño atemporal, ideal para realzar mesas que buscan sofisticación, calidad y un aire de tradición renovada.

The Berlín series stands for durability and style with its oval shapes and classic design, ideal to enhance tables where sophistication, quality and a touch of revamped tradition is required.

La série Berlin apporte durabilité et style avec ses formes ovales et son design intemporel, idéale pour mettre en valeur les tables à la recherche de sophistication, de qualité et d'un air de tradition renouvelée.

La serie Berlín aporta durevolezza e stile grazie alle sue forme ovali e al design atemporale, ideale per dare protagonismo alle tavole che ricercano sofisticazione, qualità e un'aria di tradizione rinnovata.

A série Berlin traz durabilidade e estilo com as suas formas ovais e design intemporal, ideal para valorizar mesas que procuram sofisticação, qualidade e um ar de tradição renovada.

	Caja	Box	Boîte	Scatola	Caixa
	Acero Inoxidable	Stainless Steel	Acier Inoxydable	Acciaio Inossidabile	Aço Inoxidável



561200



Cuchillo Pescado // Fish Knife
 Couteau Poisson // Coltello Pesce
 Faca Peixe



560200



Cuchillo Lunch (Dentado)
 Cake Knife (Serrated)
 Couteau Lunch (Microdenté)
 Coltello Frutta (Dentato)
 Faca Lunch (Serrilhada)



560600



Cuchillo Postre (Dentado)
 Dessert Knife (Serrated)
 Couteau Dessert (Microdenté)
 Coltello Frutta (Dentato)
 Faca Sobremesa (Serrilhada)



560900



Cuchillo Mesa (Dentado)
 Table Knife (Serrated)
 Couteau Table (Microdenté)
 Coltello Tavola (Dentato)
 Faca Mesa (Serrilhada)



560902



Cuchillo Mesa (Microdentado)
 Table Knife (Micro-Serrated)
 Couteau Table (Microcranté)
 Coltello Tavola (Microdentato)
 Faca Mesa (Micro-Serrilhada)

	Caja	Box	Boîte	Scatola	Caixa
	Acero Inoxidable 18/10	Stainless Steel 18/10	Acier Inoxydable 18/10	Acciaio Inossidabile 18/10	Aço Inoxidável 18/10



560100



Cuchara Moka // Mocca Spoon
Cuillère Moka // Cucchiaino Moka
Colher Moka



560500

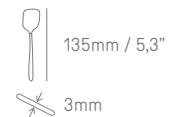

Cuchara Helado // Ice Cream Spoon // Cuillère à Glace // Paletta Gelato // Colher Gelado



560300



Cuchara Café // Coffee Spoon
Cuillère Café // Cucchiaino Caffè
Colher Café



560700

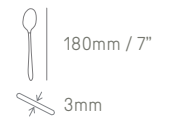

Cuchara Postre // Dessert Spoon
Cuillère Dessert // Cucchiaino Frutta // Colher Sobremesa



561000

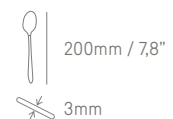

Cuchara Mesa // Table Spoon
Cuillère Table // Cucchiaino Tavola
Colher mesa

	Caja	Box	Boîte	Scatola	Caixa
	Acero Inoxidable 18/10	Stainless Steel 18/10	Acier Inoxydable 18/10	Acciaio Inossidabile 18/10	Aço Inoxidável 18/10



561600

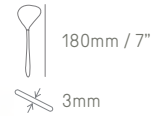

Cacillo Salsa // Gravy Ladle
Louche à Crème // Mestolo Salsa
Concha Molho



562100

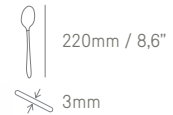

Cuchara Refresco // Iced Tea Spoon // Cuillère à Glace
Cucchiaino Tè // Colher Refresco



561800



Cuchara Servir // Serving Spoon
Cuillère Service // Cucchiaione Servire // Colher Servir



562000

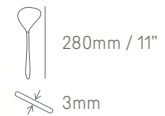

Cazo Sopa // Soup Ladle
Louche // Mestolo // Concha Sopa



561900

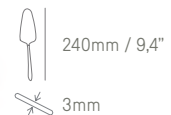

Pala Pastel // Cake Server // Pelle à Tarte // Pala Torta // Pá Torta

	Caja	Box	Boîte	Scatola	Caixa
	Acero Inoxidable 18/10	Stainless Steel 18/10	Acier Inoxydable 18/10	Acciaio Inossidabile 18/10	Aço Inoxidável 18/10



560400



Tenedor Lunch // Cake Fork
Fourchette Lunch // Forchetta
Frutta // Garfo Lunch



560800



Tenedor Postre // Dessert Fork
Fourchette Dessert // Forchettina
Dolce // Garfo Sobre mesa



561300

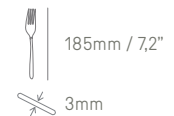

Tenedor Pescado // Fish Fork
Fourchette Poisson // Forchettina
Pesce // Garfo Peixe



561100

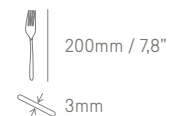

Tenedor Mesa // Table Fork
Fourchette Table // Forchetta
Tavola // Garfo Mesa







561700



Tenedor Servir // Serving Fork
Fourchette Service // Forchettone
Servire // Garfo Servir

	Estuche	Gift Case	Ménagère	Confezione Regalo	Caixa de Presente
	5609. Acero Inoxidable 5603, 5610, 5611. Acero Inoxidable 18/10	5609. Stainless Steel 5603, 5610, 5611. Stainless Steel 18/10	5609. Acier Inoxydable 5603, 5610, 5611. Acier Inoxydable 18/10	5609. Acciaio Inossidabile 5603, 5610, 5611. Acciaio Inossidabile 18/10	5609. Aço Inoxidável 5603, 5610, 5611. Aço Inoxidável 18/10



-  6 X 5609
-  6 X 5610
-  6 X 5611
-  6 X 5603















24



562400

Estuche 24 Piezas // 24 Pc. Set
Ménagère 24 Pièces // Confezione 24 Pezzi
Conjunto 24 Peças

	Maletín	Gift Case	Ménagère	Astuccio	Maleta
	5609, 5602, 5612. Acero Inoxidable 5610, 5611, 5603, 5604, 5601, 5612, 5613, 5620, 5618, 5617, 5616, 5619. Acero Inoxidable 18/10	5609, 5602, 5612. Stainless Steel 5610, 5611, 5603, 5604, 5601, 5612, 5613, 5620, 5618, 5617, 5616, 5619. Stainless Steel 18/10	5609, 5602, 5612. Acier Inoxydable 5610, 5611, 5603, 5604, 5601, 5612, 5613, 5620, 5618, 5617, 5616, 5619. Acier Inoxydable 18/10	5609, 5602, 5612. Acciaio Inossidabile 5610, 5611, 5603, 5604, 5601, 5612, 5613, 5620, 5618, 5617, 5616, 5619. Acciaio Inossidabile 18/10	5609, 5602, 5612. Aço Inoxidável 5610, 5611, 5603, 5604, 5601, 5612, 5613, 5620, 5618, 5617, 5616, 5619. Aço Inoxidável 18/10

-  12 X 5609
-  12 X 5610
-  12 X 5611
-  12 X 5602
-  12 X 5603
-  12 X 5604
-  12 X 5601
-  12 X 5612
-  12 X 5613
-  1 X 5620
-  1 X 5618
-  1 X 5617
-  1 X 5616
-  1 X 5619

113



562500

Maletín 113 Piezas // 113 pc. Gift Case
Ménagère 113 pièces // Astuccio 113 Pezzi
Conjunto 113 Peças



SERIE TOSCANA



Una serie que define la sencillez y elegancia, aportando distinción natural a cualquier mesa, ideal para quienes valoran la belleza sin complicaciones.

A series that defines simplicity and elegance, adding natural distinction to any table, ideal for anyone who values uncomplicated beauty.

Une série qui définit la simplicité et l'élégance, apportant une distinction naturelle à n'importe quelle table, idéale pour ceux qui apprécient la beauté sans complication.

Una serie che definisce la semplicità e l'eleganza, fornendo una raffinatezza naturale a ogni tavola, ideale per chi apprezza la bellezza senza complicazioni.

Uma coleção que traduz simplicidade e elegância, conferindo uma distinção natural a qualquer mesa, ideal para quem aprecia a beleza descomplicada.

	Caja	Box	Boîte	Scatola	Caixa
	Acero Inoxidable	Stainless Steel	Acier Inoxydable	Acciaio Inossidabile	Aço Inoxidável



570200



Cuchillo Lunch (Dentado)
 Cake Knife (Serrated)
 Couteau Lunch (Microdenté)
 Coltello Frutta (Dentato)
 Faca Lunch (Serrilhada)



570600



Cuchillo Postre (Dentado)
 Dessert Knife (Serrated)
 Couteau Dessert (Microdenté)
 Coltello Frutta (Dentato)
 Faca Sobremesa (Serrilhada)



570900

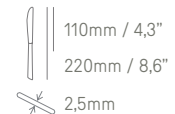



Cuchillo Mesa (Dentado)
 Table Knife (Serrated)
 Couteau Table (Microdenté)
 Coltello Tavola (Dentato)
 Faca Mesa (Serrilhada)

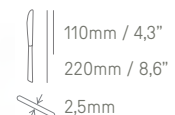

570902



Cuchillo Mesa (Microdentado)
 Table Knife (Micro-Serrated)
 Couteau Table (Microcranté)
 Coltello Tavola (Microdentato)
 Faca Mesa (Micro-Serrilhada)

	Caja	Box	Boite	Scatola	Caixa
	Acero Inoxidable 18/10	Stainless Steel 18/10	Acier Inoxydable 18/10	Acciaio Inossidabile 18/10	Aço Inoxidável 18/10



570100

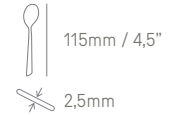

Cuchara Moka // Mocca Spoon
Cuillère Moka // Cucchiaino Moka
Colher Moka



570300

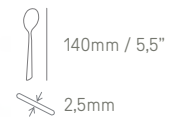

Cuchara Café // Coffee Spoon
Cuillère Café // Cucchiaino Caffè
Colher Café



570700



Cuchara Postre // Dessert Spoon
Cuillère Dessert // Cucchiaino
Frutta // Colher Sobremesa



571000

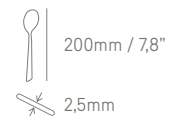

Cuchara Mesa // Table Spoon
Cuillère Table // Cucchiaino Tavola
Colher mesa



572100

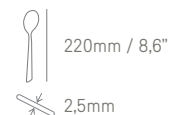

Cuchara Refresco // Iced Tea Spoon
Cuillère à Glace
Cucchiaino Tè // Colher Refresco

	Caja	Box	Boîte	Scatola	Caixa
	Acero Inoxidable 18/10	Stainless Steel 18/10	Acier Inoxydable 18/10	Acciaio Inossidabile 18/10	Aço Inoxidável 18/10



570400

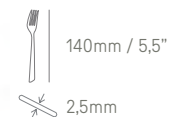

Tenedor Lunch // Cake Fork
 Fourchette Lunch // Forchetta
 Frutta // Garfo Lunch



570800



Tenedor Postre // Dessert Fork
 Fourchette Dessert // Forchettina
 Dolce // Garfo Sobremesa



571100

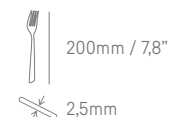

Tenedor Mesa // Table Fork
 Fourchette Table // Forchetta
 Tavola // Garfo Mesa

	Estuche	Gift Case	Ménagère	Confezione Regalo	Caixa de Presente
	5709 Acero Inoxidable 5703, 5710, 5711, Acero Inoxidable 18/10	5709 Stainless Steel 5703, 5710, 5711, Stainless Steel 18/10	5709 Acier Inoxydable 5703, 5710, 5711, Acier Inoxydable 18/10	5709 Acciaio Inossidabile 5703, 5710, 5711, Acciaio Inossidabile 18/10	5709 Aço Inoxidável 5703, 5710, 5711, Aço Inoxidável 18/10



6 X 5709



6 X 5710



6 X 5711





6 X 5703

24



572400

Estuche 24 Piezas // 24 Pc. Set
 Ménagère 24 Pièces // Confezione 24 Pezzi
 Conjunto 24 Peças

	Display	Display	Carte	Display	Display
	Acero Inoxidable	Stainless Steel	Acier Inoxydable	Acciaio Inossidabile	Aço Inoxidável



575000

110mm / 4,3"
220mm / 8,6"

Cuchillo Mesa (Dentado)
Table Knife (Serrated)
Couteau Table (Microdenté)
Coltello Tavola (Dentato)
Faca Mesa (Serrilhada)

3 X 570900



574900

90mm / 3,5"
205mm / 8"

Cuchillo Postre (Dentado)
Dessert Knife (Serrated)
Couteau Dessert (Microdenté)
Coltello Frutta (Dentato)
Faca Sobremesa (Serrilhada)

3 X 570600





574800

85mm / 3,3"
185mm / 7,2"

Cuchillo Lunch (Dentado)
Cake Knife (Serrated)
Couteau Lunch (Microdenté)
Coltello Frutta (Dentato)
Faca Lunch (Serrilhada)

3 X 570200

	Display	Display	Carte	Display	Display
	Acero Inoxidable 18/10	Stainless Steel 18/10	Acier Inoxydable 18/10	Acciaio Inossidabile 18/10	Aço Inoxidável 18/10



574700

200mm / 7,8"

Tenedor Mesa
Table Fork
Fourchette Table
Forchetta Tavola
Garfo Mesa

3 X 571100



574500

180mm / 7"

Tenedor Postre
Dessert Fork
Fourchette Dessert
Forchettina Dolce
Garfo Sobremesa

3 X 570800



574300

140mm / 5,5"

Tenedor Lunch
Cake Fork
Fourchette Lunch
Forchetta Frutta
Garfo Lunch

6 X 570400

	Display	Display	Carte	Display	Display
	Acero Inoxidable 18/10	Stainless Steel 18/10	Acier Inoxydable 18/10	Acciaio Inossidabile 18/10	Aço Inoxidável 18/10



574100

 115mm / 4,5"

Cuchara Moka
Mocca Spoon Cuillère Moka
Cucchiaino Moka
Colher Moka

6 X 570100



574200

 140mm / 5,5"

Cuchara Café
Coffee Spoon
Cuillère Café
Cucchiaino Caffè
Colher Café

6 X 570300



574400

 180mm / 7"

Cuchara Postre
Dessert Spoon
Cuillère Dessert
Cucchiaino Frutta
Colher Sobremesa

6 X 570700



574600

 200mm / 7,8"

Cuchara Mesa
Table Spoon
Cuillère Table
Cucchiaino Tavola
Colher Mesa

3 X 571000

TIJERAS



SCISSORS
CISEAUX
FORBICI
TESOURAS

FORGED
PÁG 229



ECOPRO
PÁG 231



PROCHEF
PÁG 233



DELUXE
PÁG 238



STYLE
PÁG 241





SERIE FORGED

Tijeras de cocina forjadas, perfectas para cortes de precisión. Herramientas fuertes para chefs y carniceros exigentes que valoran la durabilidad y el rendimiento.

Forged kitchen scissors, perfect for precise cuts. Strong tools for demanding chefs and butchers who value durability and performance.

Ciseaux de cuisine forgés, parfaits pour les coupes de précision. Des outils solides pour les chefs et les bouchers exigeants qui apprécient la durabilité et la performance.

Forbici da cucina forgiate, perfette per tagli di precisione. Strumenti forti per chef e macellai esigenti, che apprezzano la durezza e le prestazioni.

Tesouras de cozinha forjadas, perfeitas para cortes de precisão. Ferramentas fortes para chefs e carneiros exigentes que valorizam a durabilidade e o desempenho.

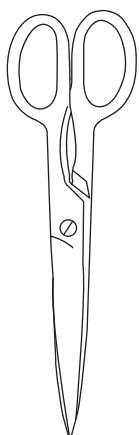

Acero Inoxidable Forjado

Forged Stainless Steel · Acier Inoxydable Forgé
Acciaio Inossidabile Forgiato · Aço Inoxidável Forjado.

Gran Potencia de Corte.

Great Cutting Power · Grande Puissance de Coupe · Grande Potenza di Taglio · Grande Poder de Corte.

Corte de Alimentos Cárnicos.

Cutting of Meat · Coupe des Aliments carnés · Taglio di Alimenti Carnosi · Corte de Alimentos Cárneos.

Resistente a la Corrosión

Corrosion Resistant · Résistants à la Corrosion · Resistenti alla Corrosione · Resistentes à Corrosão.

	Funda Display - Display Sleeve - Carte - Display - Capa expositora
	Acero Inoxidable Forjado Forged Stainless Steel Acier Inoxydable Forgé Acciaio Inossidabile Forgiato Aço Inoxidável Forjado



507010

200mm / 7,8"



Tijeras Cocina // Kitchen Scissors
Ciseaux Cuisine // Forbici Cucina
Tesouras Cozinha

	Funda Display - Display Sleeve - Carte - Display - Capa expositora
	Acero Inoxidable Forjado Forged Stainless Steel Acier Inoxydable Forgé Acciaio Inossidabile Forgiato Aço Inoxidável Forjado



507100

225mm / 8,8"



Tijeras Cocina // Kitchen Scissors
Ciseaux Cuisine // Forbici Cucina
Tesouras Cozinha



SERIE ECOPRO

Máxima precisión en tareas especializadas. Ergonómicamente diseñadas para un rendimiento superior, adaptadas a cada tarea específica con el mínimo esfuerzo requerido.

Maximum precision in specialised jobs. Ergonomically designed for supreme performance, adapted to each specific task that requires the minimum effort.

Précision maximale dans les tâches spécialisées. Une conception ergonomique pour des performances supérieures, adaptés à chaque tâche spécifique avec un minimum d'effort requis.

Massima precisione per lavori specializzati. Progettate ergonomicamente per una resa superiore, adattate a ogni specifico lavoro al fine di applicare sempre il minimo sforzo.

Máxima precisão em tarefas especializadas. Ergonómicamente concebida para um desempenho superior, adaptada a cada tarefa específica com o mínimo esforço necessário.

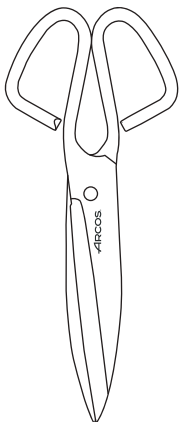

Materiales Resistentes

Resistant Materials · Matériaux résistants · Materiali Resistenti · Materiais Resistentes.

Máxima Precisión

Maximum Precision · Précision Maximale · Massima Precisione · Máxima Precisão.

Uso en Tareas Especializadas

Use in Specialized Tasks · Utilisation Dans des Tâches Spécialisées · Uso in Compiti Specializzati · Uso em Tarefas Especializadas.

Asas Ergonómicas

Ergonomic Handles · Poignées Ergonomiques · Manici Ergonomici · Cabos Ergonómicos.

	Display
	<p>Acero Inoxidable con Recubrimiento de Tungsteno Stainless Steel with Tungsten Coating Acier Inoxydable Recouvert de Tungstène Acciaio Inossidabile Ricoperto in Tungsteno Aço Inoxidável com Revestimento de Tungstênio</p> <p>Polipropileno // Polypropylene Polypropylèn // Polipropilene Polipropileno</p>





506100

145mm / 5,7"



Tijeras Electricista // Electrician Shears // Ciseaux Électricien Forbici Elettricista // Tesouras Electricista

	Caja - Box - Boîte - Scatola - Caixa
	<p>Acero Inoxidable Stainless Steel Acier Inoxydable Acciaio Inossidabile Aço Inoxidável</p>





809700

200mm / 7,8"



Tijeras Cocina // Kitchen Scissors Ciseaux Cuisine // Forbici Cucina Tesouras Cozinha

	Caja - Box - Boîte - Scatola - Caixa
	<p>Acero Inoxidable Stainless Steel Acier Inoxydable Acciaio Inossidabile Aço Inoxidável</p>





809800

240mm/9,4"



Tijeras Cocina // Kitchen Scissors Ciseaux Cuisine // Forbici Cucina Tesouras Cozinha

	Caja - Box - Boîte - Scatola - Caixa
	<p>Acero Inoxidable Forjado Forged Stainless Steel Acier Inoxydable Forgé Acciaio Inossidabile Forgiato Aço Inoxidável Forjado</p>





539000

250mm / 9,8"



Tijeras Pollo // Poultry Shears Cisaille à Volailles Inox Trinciapollo // Tesouras Frango

	Caja - Box - Boîte - Scatola - Caixa
	<p>Acero Inoxidable Stainless Steel Acier Inoxydable Acciaio Inossidabile Aço Inoxidável</p> <p>Polipropileno // Polypropylene Polypropylène // Polipropilene Polipropileno</p>



539100

240mm / 9,4"



Tijeras Pollo // Poultry Shears Cisaille à Volailles Inox Trinciapollo // Tesouras Frango



SERIE PROCHEF

Las tijeras PROCHEF son herramientas esenciales de cocina, con un diseño robusto y un eje de giro avanzado para máxima fuerza. Perfectas para cortar carnes y huesos, facilitando cualquier tarea culinaria.

The PROCHEF scissors are essential kitchen utensils, with a robust design and an advanced axis of rotation for maximum strength. Perfect to cut meat and bones, making any culinary task easy.

Les ciseaux PROCHEF sont des outils de cuisine essentiels, avec une conception robuste et un axe pivotant avancé pour une force maximale. Parfaits pour couper la viande et les os, facilitant ainsi toutes les tâches culinaires.

Le forbici PROCHEF sono strumenti indispensabili in cucina, grazie al design robusto e un fulcro di rotazione avanzato che consente di esercitare la massima forza. Perfette per tagliare carni e ossa, agevolano qualsiasi lavoro culinario.

As tesouras PROCHEF são um utensílio de cozinha indispensável, com um design robusto e um eixo pivotante avançado para máxima resistência. Perfeitas para cortar carne e ossos, facilitando qualquer tarefa culinária.

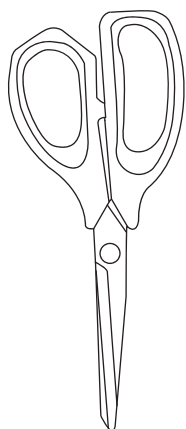

Acero Inoxidable

Stainless steel · Acier Inoxydable · Tacciaio Inossidabile
Aço Inoxidável.

Variedad de Tamaños y Colores

Variety of sizes and Colors · Variété de Tailles et de Couleurs · Varie
Dimensioni e Colori · Variedade de Tamanhos e Cores.

Uso en Tareas Especializadas

Use in Specialized Tasks · Utilisation Dans des Tâches
Spécialisées · Uso in Compiti Specializzati · Uso em Tarefas
Especializadas.

Corte de Alimentos Cárnicos

Cutting of meat · Coupe des aliments carnés · Taglio di alimenti
carnosi · Corte de alimentos cárneos

	Caja - Box - Boîte - Scatola - Caixa
	<p>Acero Inoxidable Stainless Steel Acier Inoxydable Acciaio Inossidabile Aço Inoxidável</p> <p>Polipropileno // Polypropylene Polypropylène // Polipropilene Polipropileno</p>



784901

195mm / 7,6"



Tijeras Cocina Desmontable
Kitchen Scissors Dismountables
Ciseaux Cuisine Démontable
Forbici Cucina Smontabili
Tesoura Cozinha Desmontável

	Caja - Box - Boîte - Scatola - Caixa
	<p>Acero Inoxidable Stainless Steel Acier Inoxydable Acciaio Inossidabile Aço Inoxidável</p> <p>Polipropileno // Polypropylene Polypropylène // Polipropilene Polipropileno</p>



784911

195mm/7,6"



Tijeras Cocina Desmontable
Kitchen Scissors Dismountables
Ciseaux Cuisine Démontables
Forbici Cucina Smontabili
Tesoura Cozinha Desmontável

	Caja - Box - Boîte - Scatola - Caixa
	<p>Acero Inoxidable Stainless Steel Acier Inoxydable Acciaio Inossidabile Aço Inoxidável</p> <p>Polipropileno // Polypropylene Polypropylène // Polipropilene Polipropileno</p>



185601

215mm / 8,4"



Tijeras Cocina // Kitchen Scissors
Ciseaux Cuisine // Forbici Cucina
Tesouras Cozinha

	Caja - Box - Boîte - Scatola - Caixa
	<p>Acero Inoxidable Stainless Steel Acier Inoxydable Acciaio Inossidabile Aço Inoxidável</p> <p>Polipropileno // Polypropylene Polypropylène // Polipropilene Polipropileno</p>



185621

215mm / 8,4"



Tijeras Cocina // Kitchen Scissors
Ciseaux Cuisine // Forbici Cucina
Tesouras Cozinha

	Caja - Box - Boîte - Scatola - Caixa
	<p>Acero Inoxidable Stainless Steel Acier Inoxydable Acciaio Inossidabile Aço Inoxidável</p> <p>Polipropileno // Polypropylene Polypropylène // Polipropilene Polipropileno</p>



185622

215mm / 8,4"



Tijeras Cocina // Kitchen Scissors
Ciseaux Cuisine // Forbici Cucina
Tesouras Cozinha

	Caja - Box - Boîte - Scatola - Caixa
	<p>Acero Inoxidable Stainless Steel Acier Inoxydable Acciaio Inossidabile Aço Inoxidável</p> <p>Polipropileno // Polypropylene Polypropylène // Polipropilene Polipropileno</p>



185623

215mm / 8,4"



Tijeras Cocina // Kitchen Scissors
Ciseaux Cuisine // Forbici Cucina
Tesouras Cozinha

	Caja - Box - Boîte - Scatola - Caixa
	<p>Acero Inoxidable Stainless Steel Acier Inoxydable Acciaio Inossidabile Aço Inoxidável</p> <p>Polipropileno // Polypropylene Polypropylène // Polipropilene Polipropileno</p>



185625

215mm / 8,4"



Tijeras Cocina // Kitchen Scissors
Ciseaux Cuisine // Forbici Cucina
Tesouras Cozinha

	Caja - Box - Boîte - Scatola - Caixa
	<p>Acero Inoxidable Stainless Steel Acier Inoxydable Acciaio Inossidabile Aço Inoxidável</p> <p>Polipropileno // Polypropylene Polypropylène // Polipropilene Polipropileno</p>



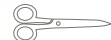

185610

215mm / 8,4"



Tijeras Cocina // Kitchen Scissors
Ciseaux Cuisine // Forbici Cucina
Tesouras Cozinha

	Caja - Box - Boîte - Scatola - Caixa
	<p>Acero Inoxidable Stainless Steel Acier Inoxydable Acciaio Inossidabile Aço Inoxidável</p> <p>Polipropileno // Polypropylene Polypropylène // Polipropilene Polipropileno</p>



185701

235mm / 9,2"



Tijeras Cocina // Kitchen Scissors
Ciseaux Cuisine // Forbici Cucina
Tesouras Cozinha

	Caja - Box - Boîte - Scatola - Caixa
	<p>Acero Inoxidable Stainless Steel Acier Inoxydable Acciaio Inossidabile Aço Inoxidável</p> <p>Polipropileno // Polypropylene Polypropylène // Polipropilene Polipropileno</p>





185721

235mm / 9,2"



Tijeras Cocina // Kitchen Scissors
Ciseaux Cuisine // Forbici Cucina
Tesouras Cozinha

	Caja - Box - Boîte - Scatola - Caixa
	<p>Acero Inoxidable Stainless Steel Acier Inoxydable Acciaio Inossidabile Aço Inoxidável</p> <p>Polipropileno // Polypropylene Polypropylène // Polipropilene Polipropileno</p>



185722

235mm / 9,2"

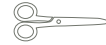

Tijeras Cocina // Kitchen Scissors
Ciseaux Cuisine // Forbici Cucina
Tesouras Cozinha

	Caja - Box - Boîte - Scatola - Caixa
	<p>Acero Inoxidable Stainless Steel Acier Inoxydable Acciaio Inossidabile Aço Inoxidável</p> <p>Polipropileno // Polypropylene Polypropylène // Polipropilene Polipropileno</p>



185723

235mm / 9,2"



Tijeras Cocina // Kitchen Scissors
Ciseaux Cuisine // Forbici Cucina
Tesouras Cozinha

	Caja - Box - Boîte - Scatola - Caixa
	<p>Acero Inoxidable Stainless Steel Acier Inoxydable Acciaio Inossidabile Aço Inoxidável</p> <p>Polipropileno // Polypropylene Polypropylène // Polipropilene Polipropileno</p>





185725

235mm / 9,2"



Tijeras Cocina // Kitchen Scissors
Ciseaux Cuisine // Forbici Cucina
Tesouras Cozinha

	Caja - Box - Boîte - Scatola - Caixa
	Acero Inoxidable Stainless Steel Acier Inoxydable Acciaio Inossidabile Aço Inoxidável ABS





185400

215mm / 8,4"



Tijeras Cocina Desmontable
Kitchen Scissors Dismountable
Ciseaux Cuisine Démontable
Forbici Cucina Smontabili
Tesoura Cozinha Desmontável

	Caja - Box - Boîte - Scatola - Caixa
	Acero Inoxidable Stainless Steel Acier Inoxydable Acciaio Inossidabile Aço Inoxidável ABS



185500

210mm / 8,2"



Tijeras Cocina // Kitchen Scissors
Ciseaux Cuisine // Forbici Cucina
Tesouras Cozinha

	Caja - Box - Boîte - Scatola - Caixa
	Acero Inoxidable Stainless Steel Acier Inoxydable Acciaio Inossidabile Aço Inoxidável ABS



186000

210mm / 8,2"



Tijeras Cocina Zurdos // Kitchen
Scissors Left-Handed // Ciseaux
Cuisine Gauchers // Forbici Cucina
Mancini // Tesouras Cozinha
Canhotos



SERIE DELUXE

La serie DELUXE destaca por su polivalencia. Tijeras diseñadas para adaptarse a una variedad de usos, desde cortar tejidos delicados hasta tareas de artesanía y manualidades.

The DELUXE series is distinguished for its versatility. Scissors designed to adapt to a variety of uses, from cutting delicate fabrics to arts and crafts.

La série DELUXE se distingue par sa polyvalence. Des ciseaux conçus pour s'adapter à une variété d'utilisations, de la coupe de tissus délicats à l'artisanat et aux travaux manuels.

La serie DELUXE si distingue per la sua versatilità. Forbici progettate per adattarsi a una gran varietà di usi, dal taglio di tessuti delicati fino a lavori di artigianato e attività manuali.

A série DELUXE destaca-se pela sua versatilidade. Tesouras concebidas para se adaptar a uma variedade de utilizações, desde o corte de tecidos delicados até às tarefas de artesanato e trabalhos manuais.

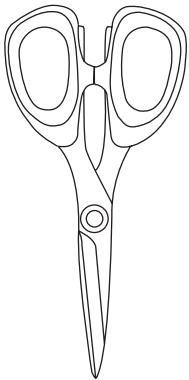

Acero Inoxidable

Stainless Steel · Acier Inoxydable · Acciaio Inossidabile
Aço Inoxidável .

Precisión de Corte

Cutting Precision · Précision de Coupe · Precisione di Taglio · Precisão de Corte.

Diseño Característico.

Characteristic Design · Design Caractéristique
Design Caratteristico · Design Característico.

Uso en Tareas Especializadas

Use in Specialized Tasks · Utilisation Dans des Tâches Spécialisées · Uso in Compiti Specializzati · Uso em Tarefas Especializadas.

Resistente a la Corrosión

Corrosion Resistant · Résistants à la Corrosion · Resistenti alla Corrosione · Resistentes à Corrosão.

	185300 Caja - Box - Boîte - Scatola - Caixa
	185301 Blister
	Acero Inoxidable Stainless Steel Acier Inoxydable Acciaio Inossidabile Aço Inoxidável
	Polipropileno // Polypropylene Polypropylène // Polipropilene Polipropileno Polipropileno



185300/185301

200mm / 7,8"



Tijeras Cocina // Kitchen Scissors
Ciseaux Cuisine // Forbici Cucina
Tesouras Cozinha

	Blister
	Acero Inoxidable Stainless Steel Acier Inoxydable Acciaio Inossidabile Aço Inoxidável
	Polipropileno // Polypropylene Polypropylène // Polipropilene Polipropileno





185324

200mm / 7,8"



Tijeras Cocina // Kitchen Scissors
Ciseaux Cuisine // Forbici Cucina
Tesouras Cozinha

	185900 Caja - Box - Boîte - Scatola - Caixa
	185901 Blister
	Acero Inoxidable Stainless Steel Acier Inoxydable Acciaio Inossidabile Aço Inoxidável
	Polipropileno // Polypropylene Polypropylène // Polipropilene Polipropileno



185900/185901

220mm / 8,6"



Tijeras Cocina // Kitchen Scissors
Ciseaux Cuisine // Forbici Cucina
Tesouras Cozinha

	Blister
	Acero Inoxidable Stainless Steel Acier Inoxydable Acciaio Inossidabile Aço Inoxidável
	Polipropileno // Polypropylene Polypropylène // Polipropilene Polipropileno





185924

220mm / 8,6"



Tijeras Cocina // Kitchen Scissors
Ciseaux Cuisine // Forbici Cucina
Tesouras Cozinha

	Caja - Box - Boîte - Scatola - Caixa
	<p>Acero Inoxidable Stainless Steel Acier Inoxydable Acciaio Inossidabile Aço Inoxidável</p> <p>ABS</p>



513500

135mm / 5,3"



Tijeras Costura // Sewing Scissors
Ciseaux Couture // Forbici Sartoria
Tesouras Costura

	Caja - Box - Boîte - Scatola - Caixa
	<p>Acero Inoxidable Stainless Steel Acier Inoxydable Acciaio Inossidabile Aço Inoxidável</p> <p>ABS</p>



516500

165mm / 6,4"



Tijeras Costura // Sewing Scissors
Ciseaux Couture // Forbici Sartoria
Tesouras Costura

	Caja - Box - Boîte - Scatola - Caixa
	<p>Acero Inoxidable Stainless Steel Acier Inoxydable Acciaio Inossidabile Aço Inoxidável</p> <p>ABS</p>



521000

210mm / 8,2"

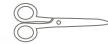

Tijeras Costura // Sewing Scissors
Ciseaux Couture // Forbici Sartoria
Tesouras Costura



SERIE STYLE

Tijeras especializadas en costura y manicura, indispensables en el mundo de la moda y el cuidado personal. Su corte preciso y diseño ergonómico las convierten en un añadido esencial para cualquier casa.

Specialised sewing and manicure scissors, indispensable in the world of fashion and personal care. Their precise cut and ergonomic design make them an essential for any home.

Des ciseaux spécialisés pour la couture et la manucure, indispensables dans le monde de la mode et des soins personnels. Leur coupe précise et leur conception ergonomique en font un complément essentiel dans tous les foyers.

Forbici specifiche per il cucito e la manicure, indispensabili nel mondo della moda e dell'igiene personale. Il loro taglio preciso e il design ergonomico le rendono un accessorio indispensabile in ogni casa.

Tesouras especializadas em costura e manicura, indispensáveis no mundo da moda e dos cuidados pessoais. O seu corte preciso e o seu design ergonómico fazem delas um complemento indispensável em qualquer casa.

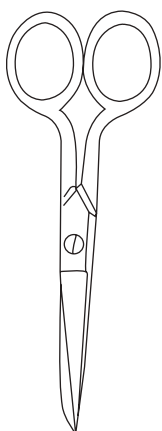

Acero Inoxidable Forjado

Forged Stainless Steel • Acier Inoxydable Forgé
Acciaio Inossidabile Forgiato • Aço Inoxidável Forjado.

Peso Ligero

Lightweight • Poids léger • Peso leggero • Peso leve.

Uso en Tareas Especializadas

Use in Specialized Tasks • Utilisation Dans des Tâches Spécialisées • Uso in Compiti Specializzati • Uso em Tarefas Especializadas.

Máxima Precisión

Maximum Precision • Précision Maximale • Massima Precisione • Máxima Precisão.

	Blister
	<p>Acero Inoxidable Forjado Forged Stainless Steel Acier Inoxydable Forgé Acciaio Inossidabile Forgiato Aço Inoxidável Forjado</p> <p>Niqueladas // Nickel Plated Nickel Nichelati // Niqueladas</p>



502200

127mm / 5"



Tijeras Costura Castellana
 Sewing Scissors Castellana Style
 Ciseaux de Couture Le Castillan
 Forbici Sartoria Castigliana
 Tesouras Costura Castelhana

	Blister
	<p>Acero Inoxidable Forjado Forged Stainless Steel Acier Inoxydable Forgé Acciaio Inossidabile Forgiato Aço Inoxidável Forjado</p> <p>Niqueladas // Nickel Plated Nickel Nichelati // Niqueladas</p>



502300

140mm / 5,5"

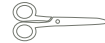

Tijeras Costura Castellana
 Sewing Scissors Castellana Style
 Ciseaux de Couture Le Castillan
 Forbici Sartoria Castigliana
 Tesouras Costura Castelhana

	Blister
	<p>Acero Inoxidable Forjado Forged Stainless Steel Acier Inoxydable Forgé Acciaio Inossidabile Forgiato Aço Inoxidável Forjado</p> <p>Niqueladas // Nickel Plated // Nickel Nichelati // Niqueladas</p>



502400

152mm / 5,9"



Tijeras Costura Castellana
 Sewing Scissors Castellana Style
 Ciseaux de Couture Le Castillan
 Forbici Sartoria Castigliana
 Tesouras Costura Castelhana

	Blister
	<p>Acero Inoxidable Forjado Forged Stainless Steel Acier Inoxydable Forgé Acciaio Inossidabile Forgiato Aço Inoxidável Forjado</p> <p>Niqueladas // Nickel Plated // Nickel Nichelati // Niqueladas</p>



500600

102mm / 4"

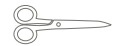

Tijeras de Manicura Curva
 Manicure Scissors Curved
 Ciseaux à Angles Lame Coyrbée
 Forbici Unghie Lama Curva
 Tesouras Manicure Curva

	Blister
	<p>Acero Inoxidable Forjado Forged Stainless Steel Acier Inoxydable Forgé Acciaio Inossidabile Forgiato Aço Inoxidável Forjado</p> <p>Niqueladas // Nickel Plated // Nickel Nichelati // Niqueladas</p>



501100

102mm / 4"



Tijeras de Uñas Recta // Nail
 Scissors Straight // Ciseaux à
 Angles Lame Droite // Forbici
 Unghie Lama Diritta // Tesouras
 Manicure Reta

	Blister
	<p>Acero Inoxidable Forjado Forged Stainless Steel Acier Inoxydable Forgé Acciaio Inossidabile Forgiato Aço Inoxidável Forjado</p> <p>Niqueladas // Nickel Plated // Nickel Nichelati // Niqueladas</p>



504200

178mm / 7"



Tijeras de Modista // Dressmaker
 Shears // Ciseaux de Couturier
 Forbici Sarto Abiti // Tesouras
 Costureira

	Blister
	<p>Acero Inoxidable Forjado Forged Stainless Steel Acier Inoxydable Forgé Acciaio Inossidabile Forgiato Aço Inoxidável Forjado</p> <p>Niqueladas // Nickel Plated // Nickel Nichelati // Niqueladas</p>



504300

190mm / 7,4"

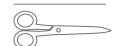

Tijeras de Modista // Dressmaker
 Shears // Ciseaux de Couturier
 Forbici Sarto Abiti // Tesouras
 Costureira

1. Crescent // Demi-lune // Mezzaluna // Meia-lua
2. Intermediate Point // Point Intermédiaire // Punto Medio // Ponto intermédio
3. Point // Pointe // Punta // Ponta
4. Sharp Blade // Lame Pointue // Lama Appuntita // Lâmina pontiaguda
5. Blade // Lame // Lama // Lâmina
6. Bevel // Tranchant // Fio
7. Back // Dos // Dorso
8. Belt // Ceinture // Cintura // Cinturão
9. Dorsal Bevel // Biseau Dorsal // Bisello Dorsale // Bisel Dorsal
10. Board Snap // Joint d'assemblage // Giunto ad Incastro // Ponto Intermédio
11. Snap Closure // Fermeture d'assemblage G // Chiusura a Incastro G // Fecho de encaixe G
12. Area Between Leaf and Eye // Zone entre la Lame et l'œil // Zona fra Lama e Occhio // Área entre lâmina e anel
13. Closing a Snap // Fermeture d'assemblage A // Chiusura dell'Incastro A // Fecho de encaixe A
14. Rome Blade // Lame Arrondie // Lama Roma // Lâmina Roma
15. Interior Face // Face Intérieure // Lato Inferiore // Face interior
16. Screw // Vis // Vite // Parafuso
17. Box // Caisse // Scatola // Caixa
18. Brand Stamp // Marque // Marca // Marca
19. Printing // Estampage Distinctif // Stampa Differenziatrice // Estampado Diferenciador
20. Eye // Oeil // Occhio // Anel
21. Singing Eye // Chant de l'œil // Bordo dell'Occhio // Canto do anel

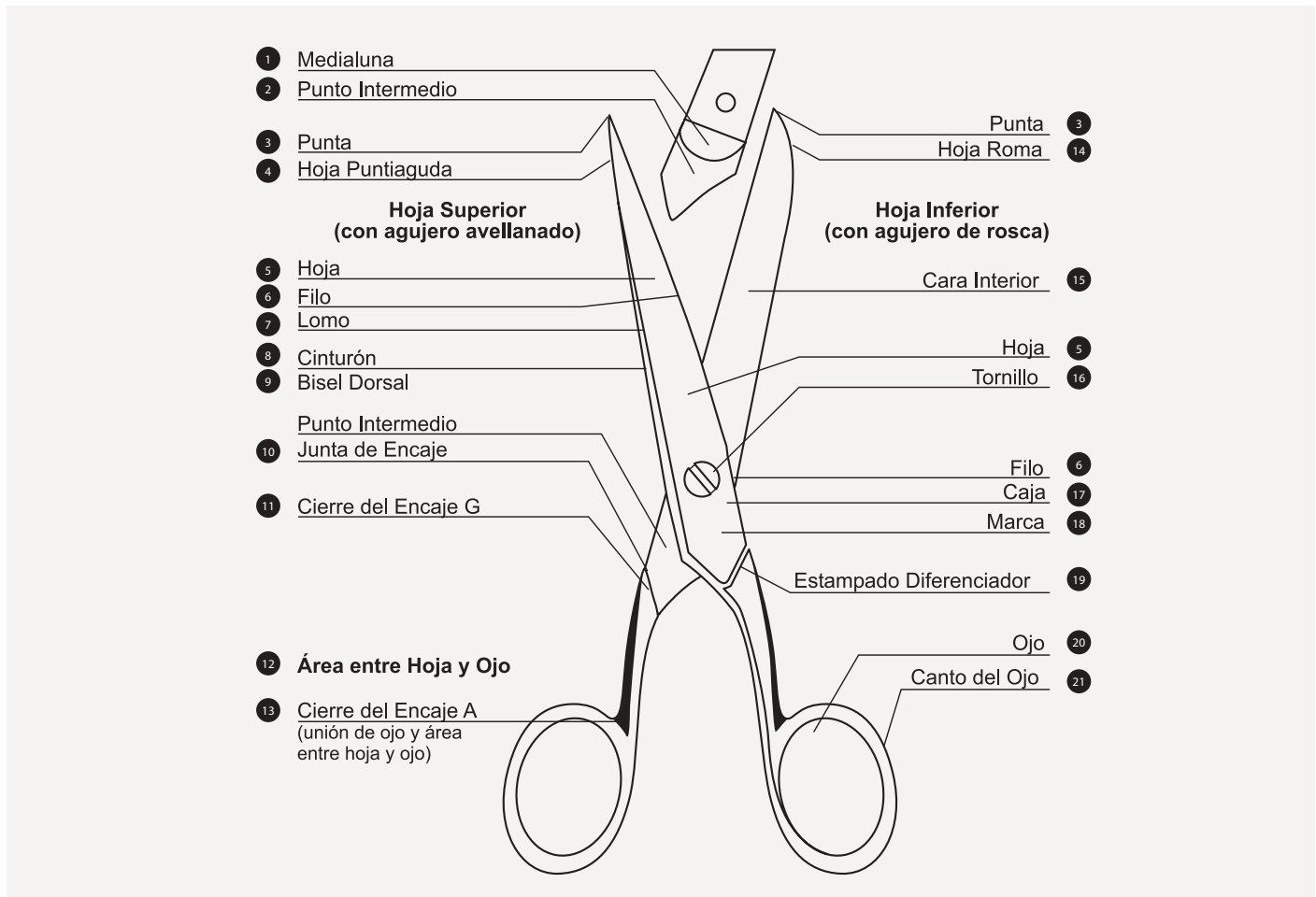

SARTENES Y
CACEROLAS



COOKWARE
POÊLES ET CASSEROLES
PADELLE E CASSERUOLE
CAÇAROLA

SAMOA
ICONIC
PÁG 247



SAMOA
PÁG 253



THERA
PÁG 261





SERIE SAMOA ICONIC

Cocción más saludable gracias a su revestimiento cerámico, libre de químicos. Con acabados en negro y beige con mangos dorados, aporta un aire de distinción a cualquier cocina.

Healthier cooking thanks to its ceramic coating, free of chemicals. With black and beige finishes and golden handles, it adds a touch of distinction to any kitchen.

Une cuisson plus saine grâce à son revêtement en céramique, sans produits chimiques. Avec des finitions noires et beiges et des poignées dorées, il apporte une touche de distinction à toute cuisine.

Cottura più salutare grazie al suo rivestimento in ceramica, privo di sostanze chimiche. Con finiture nere e beige e manici dorati, aggiunge un tocco di distinzione a qualsiasi cucina.

Cozimento mais saudável graças ao seu revestimento cerâmico, livre de produtos químicos. Com acabamentos em preto e bege e cabos dourados, adiciona um toque de distinção a qualquer cozinha.

FORGED ALUMINIUM

CERAMIC COATING

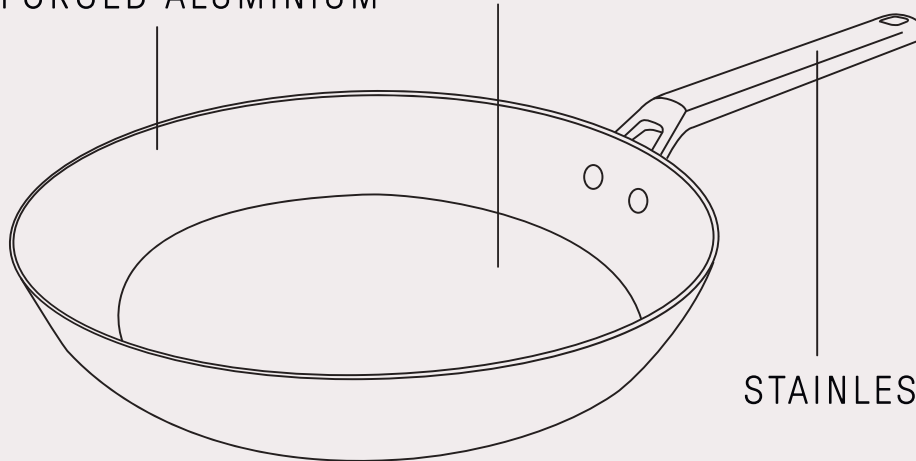

STAINLESS STEEL



Libre de PFOA // Free PFOA // Sans PFOA // Senza PFOA // Livre de PFOA



Ahorro energético // Energy saving
Économie d'énergie // Risparmio Energetico // Economia de Energia



Con reparto Uniforme del Calor
Saving with Uniform Heat Distribution.
Avec une Répartition Uniforme de la Chaleur.
Con Distribuzione Uniforme del Calore.
Com Distribuição Uniforme do Calor.

La serie Samoa Iconic combina tecnología cerámica antiadherente, distribución uniforme del calor y resistencia excepcional. Apta para todo tipo de cocinas y horno (hasta 220°C), ofrecen cocción saludable, ahorro energético y fácil limpieza, ideales para quienes buscan rendimiento y versatilidad en la cocina.

The Samoa Iconic series combines non-stick ceramic technology, even heat distribution, and exceptional durability. Suitable for all types of stoves and ovens (up to 220°C), it offers healthy cooking, energy savings, and easy cleaning ideal for those seeking performance and versatility in the kitchen.

La série Samoa Iconic combine une technologie céramique antiadhésive, une répartition uniforme de la chaleur et une résistance exceptionnelle. Adaptée à tous types de cuisines et au four (jusqu'à 220°C), elle offre une cuisson saine, des économies d'énergie et un nettoyage facile, idéale pour ceux qui recherchent performance et polyvalence en cuisine.

La serie Samoa Iconic combina tecnologia ceramica antiaderente, distribuziune uniforme del calore e resistencia eccezionale. Adatta a tutti i tipi di cucine e forni (fino a 220°C), offre una cottura salutare, risparmio energetico e facile pulizia, ideale per chi cerca prestazioni e versatilità in cucina.

A série Samoa Iconic combina tecnologia cerâmica antiaderente, distribuição uniforme de calor e resistência excepcional. Adequada para todos os tipos de fogões e forno (até 220°C), oferece cozimento saudável, economia de energia e fácil limpeza ideal para quem busca desempenho e versatilidade na cozinha.



Recubrimiento Antiadherente cerámico
Ceramic Non-Stick Coating
Revêtement Antiadhésif Céramique
Rivestimento Antiaderente Ceramico
Revestimento Antiaderente Cerâmico



Aluminio forjado
Forged Aluminium
Aluminium Forgé
Alluminio Forgiato
Alumínio Forjadot



Cocinas de Gas // Gas Cooktops
Cuisinières à Gaz // Cucine a Gas
Fogão a gás



Inducción // Induction
Induction // Induzione
Indução



Cocinas de Eléctricas // Electric
Cooktops // Cuisinières Électriques
Cucine Elettriche // Fogões
Elétricos



Cocinas de Cerámicas // Ceramic
Cooktops // Cuisinières Céramiques
Cucine Ceramiche // Fogões Cerâmicos



Base de Inducción
Full Induction Base
Base à Induction Totale
Base a Induzione Totale
Base de Indução Total

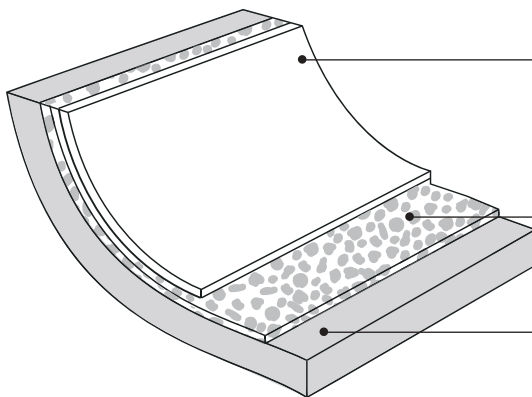

Capa superior con una anti-adherencia premium cerámico
Top layer with a premium ceramic non-stick coating
Couche supérieure avec un revêtement antiadhésif céramique premium
Strato superiore con un rivestimento antiaderente ceramico premium
Camada superior com um revestimento antiaderente cerâmico premium

Capa primera altamente reforzada / Heavily reinforced primer
Première couche hautement renforcée / Primo strato altamente rinforzato / Primeira camada altamente reforçada

Base de aluminio forjado / Metal substrate
Base en aluminium forgé / Base in alluminio forgiato / Base de alumínio forjado



EXCELLENT
RELEASE



SUPERIOR
DURABILITY



MADE WITHOUT
PFOA



MADE WITHOUT
PFOS



REGULATORY
COMPLIANT



SCRATCH
RESISTANT



HEALTHFUL
COOKING



EASY CLEAN

	Caja	Box	Boîte	Scatola	Caixa
---	------	-----	-------	---------	-------



Libre de PFOA
Free PFOA // Sans
PFOA // Senza PFOA
Livres de PFOA



NEW

16 cm
1,5 l



16cm / 6,3"
12,6cm / 4,9"

717224

Cazo Antiadherente de Aluminio Forjado // Forged Aluminum Non-Stick Saucepan // Casserole Céramique Antiadhésive en Aluminium Forgé // Pentolino Antiaderente in Alluminio Forgiato Caçarola Antiaderente de Aluminio Forjado



NEW

20 cm
1,1 l



20cm / 7,8"
13,6cm / 5,3"

716124

Sartén Antiadherente de Aluminio Forjado // Forged Aluminum Non-Stick Fry Pan // Poêle Antiadhésive en Aluminium Forgé // Padella Antiaderente in Alluminio Forgiato Frigideira Antiaderente de Aluminio Forjado



NEW

24 cm
1,8 l



24cm / 9,4"
18cm / 7"

716324

Sartén Antiadherente de Aluminio Forjado // Forged Aluminum Non-Stick Fry Pan // Poêle Antiadhésive en Aluminium Forgé // Padella Antiaderente in Alluminio Forgiato Frigideira Antiaderente de Aluminio Forjado



NEW

28 cm
2,7 l



28cm / 11"
21,8cm / 8,5"

716524

Sartén Antiadherente de Aluminio Forjado // Forged Aluminum Non-Stick Fry Pan // Poêle Antiadhésive en Aluminium Forgé // Padella Antiaderente in Alluminio Forgiato Frigideira Antiaderente de Aluminio Forjado

	Caja	Box	Boîte	Scatola	Caixa
--	------	-----	-------	---------	-------



NEW

20 cm
2,6 l

716924

 20cm / 7,8"
16cm / 6,2"

Cacerola Antiaderente de Aluminio Forjado // Forged Aluminum Non-Stick Casserole
Faitout en Aluminium Forgé Antiadhésif // Casseruola in Alluminio Forgiato Antiaderente
Caçarola de Aluminio Forjado Antiaderente



NEW

24 cm
4,3 l

717024

 24cm / 9,4"
19,8cm / 7,8"

Cacerola Antiaderente de Aluminio Forjado // Forged Aluminum Non-Stick Casserole
Faitout en Aluminium Forgé Antiadhésif // Casseruola in Alluminio Forgiato Antiaderente
Caçarola de Aluminio Forjado Antiaderente



NEW

28 cm
4,3 l

717124

 28cm / 11,2"
23,3cm / 9,1"

Cacerola Baja Antiaderente de Aluminio Forjado // Forged Aluminum Shallow Casserole
Sautoir en Aluminium Forgé Antiadhésif // Casseruola Bassa in Alluminio Forgiato Antiaderente
Caçarola Baixa de Aluminio Forjado

	Caja	Box	Boîte	Scatola	Caixa
---	------	-----	-------	---------	-------



Libre de PFOA
Free PFOA // Sans
PFOA // Senza PFOA
Livres de PFOA



NEW

16 cm
1,5 l



717222

Cazo Antiadherente de Aluminio Forjado // Forged Aluminum Non-Stick Saucepan Casserole
C ramique Antiadh sive en Aluminium Forg  // Pentolino
Antiaderente in Alluminio Forgiato
Ca arola Antiaderente de Aluminio Forjado



NEW

20 cm
1,1 l



716122

Sart n Antiadherente de Aluminio Forjado // Forged Aluminum Non-Stick Fry Pan // Po le Antiadh sive en Aluminium Forg  // Padella
Antiaderente in Alluminio Forgiato
Frigideira Antiaderente de Aluminio Forjado



NEW

24 cm
1,8 l



716322

Sart n Antiadherente de Aluminio Forjado // Forged Aluminum Non-Stick Fry Pan // Po le Antiadh sive en Aluminium Forg  // Padella
Antiaderente in Alluminio Forgiato
Frigideira Antiaderente de Aluminio Forjado



NEW

28 cm
2,7 l



716522

Sart n Antiadherente de Aluminio Forjado // Forged Aluminum Non-Stick Fry Pan // Po le Antiadh sive en Aluminium Forg  // Padella
Antiaderente in Alluminio Forgiato
Frigideira Antiaderente de Aluminio Forjado

	Caja	Box	Boîte	Scatola	Caixa
--	------	-----	-------	---------	-------



Libre de PFOA
Free PFOA // Sans
PFOA // Senza PFOA
Livre de PFOA



NEW

20 cm
2,6 l

716922

 20cm / 7,8"
16cm / 6,2"

Cacerola Antiaderente de Aluminio Forjado // Forged Aluminum Non-Stick Casserole
Faitout en Aluminium Forgé
Antiadhésif // Casseruola in Alluminio Forgiato Antiaderente
Caçarola de Aluminio Forjado Antiaderente



NEW

24 cm
4,3 l

717022

 24cm / 9,4"
19,8cm / 7,8"

Cacerola Antiaderente de Aluminio Forjado // Forged Aluminum Non-Stick Casserole
Faitout en Aluminium Forgé
Antiadhésif // Casseruola in Alluminio Forgiato Antiaderente
Caçarola de Aluminio Forjado Antiaderente



NEW

28 cm
4,3 l

717122

 28cm / 11,2"
23,3cm / 9,1"

Cacerola Baja Antiaderente de Aluminio Forjado // Forged Aluminum Shallow Casserole
Sautoir en Aluminium Forgé
Antiadhésif // Casseruola Bassa in Alluminio Forgiato Antiaderente
Caçarola Baixa de Aluminio Forjado



SERIE SAMOA

Acércate al mundo profesional culinario de la mano de esta serie creada con un diseño funcional y unas prestaciones únicas. Arrasa, deslumbra... aviva tu naturaleza. Atrévete a brillar.

Get closer to the professional culinary world with this series created with a functional design and unique features. Make a statement, dazzle... inspire yourself. Dare to shine.

Rejoignez le monde de la cuisine professionnelle avec cette gamme dotée d'une conception fonctionnelle et d'un ensemble de prestations uniques. Faites des ravages, éblouissez les vôtres... faites ressortir votre propre nature. Osez briller.

Avvicinatevi al mondo dei professionisti culinari grazie a questa serie, creata in base a un design funzionale e a delle prestazioni uniche. Spiccate, sorprendete...accentuate la vostra natura. Arrischiatevi a brillare.

Aproxime-se do mundo da cozinha profissional com esta série criada com um design funcional e características únicas. Arrasa, deslumbra... anima a sua natureza. Atreva-se a brilhar.

FORGED ALUMINIUM

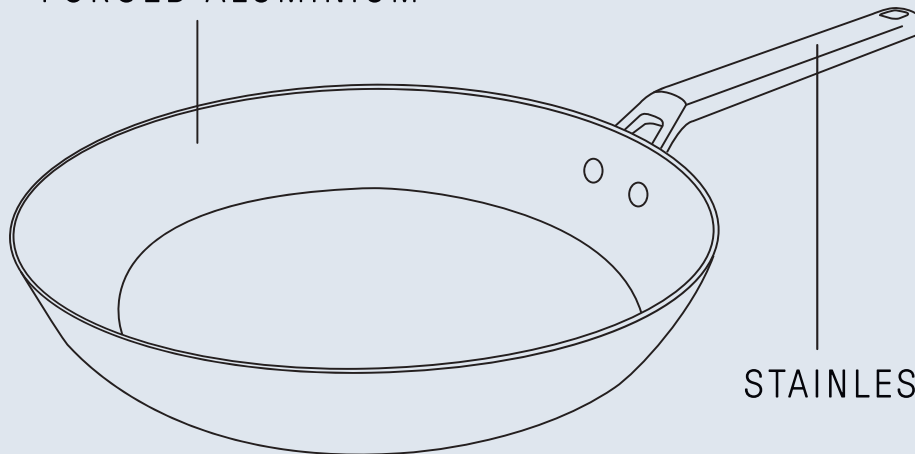

STAINLESS STEEL



Libre de PFOA // Free PFOA // Sans PFOA // Senza PFOA // Livre de PFOA



Ahorro energético // Energy saving
Économie d'énergie // Risparmio Energetico // Economia de Energia



Con reparto Uniforme del Calor
Saving with Uniform Heat Distribution.
Avec une Répartition Uniforme de la Chaleur.
Con Distribuzione Uniforme del Calore.
Com Distribuição Uniforme do Calor.

Cuerpo de aluminio forjado. Asas y mangos remachados de acero inoxidable efecto frío. Apta para todo tipo de cocinas. Sistema de ahorro energético. Fácil limpieza interior y exterior. Apta para el lavavajillas.

Forged aluminium body. Cold riveted stainless steel handles and grips. Internally reinforced non-stick system. Suitable for all kinds of kitchens. Energy saving system. Easy internal and external cleaning. Dishwasher safe.

Corps en aluminium forgé. Poignées et manches à rivets en inox effet froid. Revêtement antiadhésif renforcé. Compatible tous feux. Montée en température rapide. Nettoyage facile, intérieur et extérieur.

Corpo in alluminio forgiato. Anse e manici rivettati in acciaio inossidabile effetto freddo. Sistema antiaderente rinforzato internamente. Indicata per qualsiasi tipo di cucina. Sistema di risparmio energetico. Facile pulizia interna ed esterna. Indicata per lavaggio in lavastoviglie.

Corpo em alumínio forjado. Asas e cabos rebitados em aço inoxidável de efeito frio. Adequado para todos os tipos de fogões. Sistema de poupança energética. Fácil limpeza interior e exterior. Apta para máquina de lavar loiça. Alumínio forjado



Recubrimiento Antiadherente
Non Stick Coating
Revêtement Antiadhésif
Rivestimento Antiaderente
Revestimento Antiaderente



Aluminio forjado
Forged Aluminium
Aluminium Forgé
Alluminio Forgiato
Alumínio Forjadot



Cocinas de Gas // Gas Cooktops
Cuisinières à Gaz // Cucine a Gas
Fogão a gás



Inducción // Induction
Induction // Induzione
Indução



Cocinas de Eléctricas // Electric
Cooktops // Cuisinières Électriques
Cucine Elettriche // Fogões
Elétricos



Apto para Lavavajillas
Dishwasher Proof // Adapté
Au Lave-Vaisselle // Adatto
per il Lavaggio in Lavastoviglie
// Adequado para Lava-louças



Cocinas de Ceramicas // Ceramic
Cooktops // Cuisinières Céramiques
Cucine Ceramiche // Fogões Cerâmicos

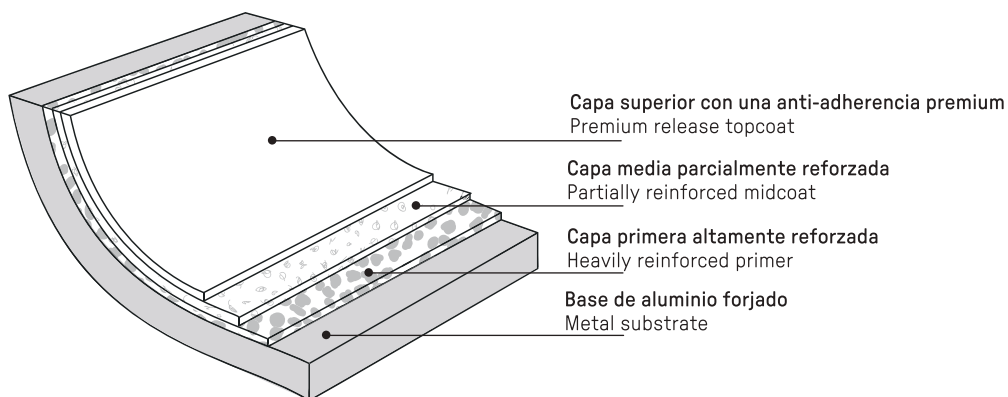

EXCELLENT
RELEASE



SUPERIOR
DURABILITY



MADE WITHOUT
PFOA



MADE WITHOUT
PFOS



REGULATORY
COMPLIANT



SCRATCH
RESISTANT



DISHWASHER
SAFE



HEALTHFUL
COOKING



EASY CLEAN

	Corbata	Sleeve	Fourreau Carton	Cartone Protettivo	Gravata Cartão
---	---------	--------	-----------------	--------------------	----------------



Libre de PFOA
Free PFOA // Sans
PFOA // Senza PFOA
Livres de PFOA



18 cm
1 l

716010



Sartén Antiadherente de Aluminio Forjado // Forged Aluminum Non-Stick Fry Pan // Poêle Antiadhésive en Aluminium Forgé // Padella Antiaderente in Alluminio Forgiato Frigideira Antiaderente de Aluminio Forjado



20 cm
1,1 l

716110



Sartén Antiadherente de Aluminio Forjado // Forged Aluminum Non-Stick Fry Pan // Poêle Antiadhésive en Aluminium Forgé // Padella Antiaderente in Alluminio Forgiato Frigideira Antiaderente de Aluminio Forjado



22 cm
1,5 l

716210



Sartén Antiadherente de Aluminio Forjado // Forged Aluminum Non-Stick Fry Pan // Poêle Antiadhésive en Aluminium Forgé // Padella Antiaderente in Alluminio Forgiato Frigideira Antiaderente de Aluminio Forjado



24 cm
1,8 l

716310

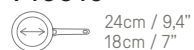

Sartén Antiadherente de Aluminio Forjado // Forged Aluminum Non-Stick Fry Pan // Poêle Antiadhésive en Aluminium Forgé // Padella Antiaderente in Alluminio Forgiato Frigideira Antiaderente de Aluminio Forjado

	Corbata	Sleeve	Fourreau Carton	Cartone Protettivo	Gravata Cartão
--	---------	--------	-----------------	--------------------	----------------



Libre de PFOA
Free PFOA // Sans
PFOA // Senza PFOA
Livre de PFOA



26 cm
2,30 l

716410



Sartén Antiadherente de Aluminio Forjado // Forged Aluminum Non-Stick Fry Pan / Poêle Antiadhésive en Aluminium Forgé // Padella Antiaderente in Alluminio Forgiato Frigideira Antiaderente de Aluminio Forjado



28 cm
2,70 l

716510



Sartén Antiadherente de Aluminio Forjado // Forged Aluminum Non-Stick Fry Pan / Poêle Antiadhésive en Aluminium Forgé // Padella Antiaderente in Alluminio Forgiato Frigideira Antiaderente de Aluminio Forjado



30 cm
3,30 l

716610



Sartén Antiadherente de Aluminio Forjado // Forged Aluminum Non-Stick Fry Pan / Poêle Antiadhésive en Aluminium Forgé // Padella Antiaderente in Alluminio Forgiato Frigideira Antiaderente de Aluminio Forjado



32 cm
3,80 l

716710

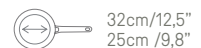

Sartén Antiadherente de Aluminio Forjado // Forged Aluminum Non-Stick Fry Pan / Poêle Antiadhésive en Aluminium Forgé // Padella Antiaderente in Alluminio Forgiato Frigideira Antiaderente de Aluminio Forjado

	Caja	Box	Boite	Scatola	Caixa
---	------	-----	-------	---------	-------



Libre de PFOA
Free PFOA // Sans
PFOA // Senza PFOA
Livre de PFOA



16 cm
1,5 l

716810

 16cm / 6,2"
12,6cm / 4,9"

Cacerola Antiaderente de Aluminio Forjado // Forged Aluminum Non-Stick Casserole
Faitout en Aluminium Forgé Antiadhésif // Casseruola in Alluminio Forgiato Antiaderente
Çaçarola de Aluminio Forjado Antiaderente



20 cm
2,6 l

716910

 20cm / 7,8"
16,1cm / 6,3"

Cacerola Antiaderente de Aluminio Forjado // Forged Aluminum Non-Stick Casserole
Faitout en Aluminium Forgé Antiadhésif // Casseruola in Alluminio Forgiato Antiaderente
Çaçarola de Aluminio Forjado Antiaderente



24 cm
4,3 l

717010

 24cm / 9,4"
19,8cm / 7,8"

Cacerola Antiaderente de Aluminio Forjado // Forged Aluminum Non-Stick Casserole
Faitout en Aluminium Forgé Antiadhésif // Casseruola in Alluminio Forgiato Antiaderente
Çaçarola de Aluminio Forjado Antiaderente



28 cm
4,3 l

717110

 28cm/11"
23,3cm / 9"

Cacerola Baja Antiaderente de Aluminio Forjado // Forged Aluminum Shallow Casserole
Sautoir en Aluminium Forgé Antiadhésif // Casseruola Bassa in Alluminio Forgiato Antiaderente
Çaçarola Baixa de Aluminio Forjado

	Corbata	Sleeve	Fourreau Carton	Cartone Protettivo	Gravata Cartão
--	---------	--------	-----------------	--------------------	----------------



Libre de PFOA
Free PFOA // Sans
PFOA // Senza PFOA
Livre de PFOA



16 cm
1,5 l

717210



16cm / 6,2"
12,6cm / 4,9"

Cazo Antiadherente de Aluminio Forjado // Forged Aluminum Non-Stick Saucepan // Casserole Céramique Antiadhésive en Aluminium Forgé // Pentolino Antiaderente in Alluminio Forgiato Caçarola Antiaderente de Aluminio Forjado



20 cm
2,6 l

717310



20cm / 7,8"
16cm / 6,3"

Cazo Antiadherente de Aluminio Forjado // Forged Aluminum Non-Stick Saucepan // Casserole Céramique Antiadhésive en Aluminium Forgé // Pentolino Antiaderente in Alluminio Forgiato Caçarola Antiaderente de Aluminio Forjado



28x28 cm
2,9 l

717410



28x28cm / 11x11"
23,2x23,2cm / 9x9"

Grill Antiadherente // Non-Stick Grill // Gril Anti-Adhésif // Grill Antiaderente // Grelhador Antiaderente



28 cm
3,8 l

717510



28cm / 11"
18,4cm / 7,2"

Wok Antiadherente // Non-Stick Wok // Wok Anti-Adhésive Wok Antiaderente // Wok Antiaderente

	Corbata	Sleeve	Fourreau Carton	Cartone Protettivo	Gravata Cartão
---	---------	--------	-----------------	--------------------	----------------



Libre de PFOA
Free PFOA // Sans
PFOA // Senza PFOA
Livres de PFOA



20-24 cm

717810



20cm-24 / 7,8-9,4"

Set de sartenes // 2 Frying Pan
Set // Set 2 Poêle // Set 2 Padelle
Set 2 Frigideiras

	Caja	Box	Boîte	Scatola	Caixa
---	------	-----	-------	---------	-------



x5

697500

Bateria de Cocina // Cookware Set
Batterie de Cuisine // Batteria da
Cucina // Conjunto de Panelas

5 Piezas // 5 Pieces // 5 Pezzi
5 Pezzi // 5 peças

 **717210**
16cm / 6,2"

 **716810**
16cm / 6,2"

 **716910**
20cm / 7,8"

 **717010**
24cm / 9,4"

 **717110**
28cm / 11"





SERIE THERA

Descubre una serie diseñada para quien se atreva a explorar su máximo potencial. Un acabado superior que imprimirá un plus de personalidad a tus creaciones. Una experiencia insuperable.

A series designed for those who have the courage to explore their fullest potential. A superior finish which will add personality to one's creations. An unsurpassable experience.

Une collection pensée pour ceux qui sont prêts à explorer pleinement leur potentiel. Avec une finition haut de gamme qui donnera une touche de personnalité sans égal à vos créations. Une expérience exceptionnelle.

Scoprite una serie progettata per chi si arrischia a esplorare fino in fondo le proprie potenzialità. Una finitura superiore, che darà un tocco aggiuntivo di personalità alle vostre creazioni. Un'esperienza insuperabile.

Descubra uma série concebida para aqueles que se atrevem a explorar todo o seu potencial. Um acabamento superior que irá dar às suas criações um toque extra de personalidade. Uma experiência insuperável.

CAST ALUMINUM

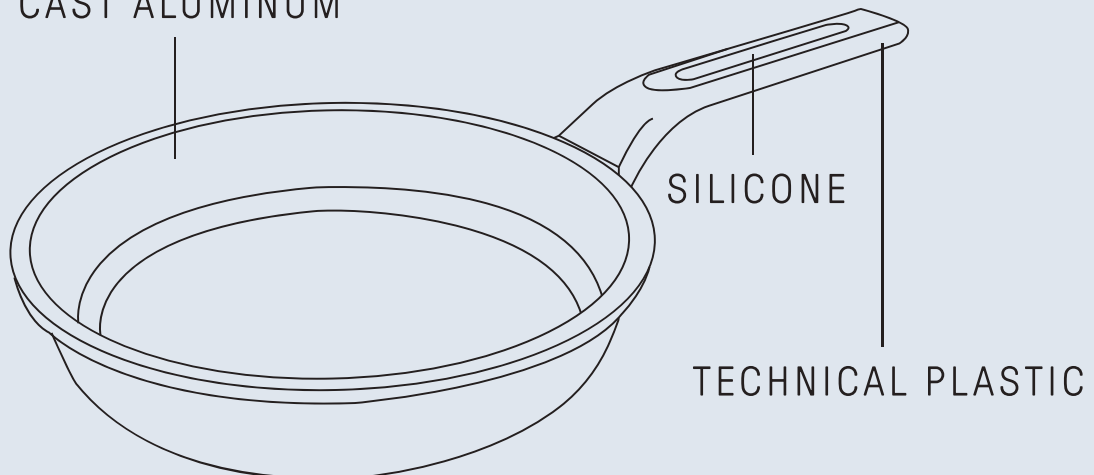



Libre de PFOA // Free PFOA // Sans PFOA // Senza PFOA // Livre de PFOA



Ahorro energético // Energy Saving
Économie d'énergie // Risparmio Energetico // Economia de Energia



Con reparto uniforme del calor
Saving with Uniform Heat Distribution.
Avec une Répartition Uniforme de la Chaleur.
Con Distribuzione Uniforme del Calore.
Com Distribuição Uniforme do Calor.

Cuerpo de aluminio fundido. Mangos ergonómicos de plástico y silicona. Asas de aluminio fundido con protectores de silicona incluidos. Sistema antiadherente reforzado internamente. Apta para todo tipo de cocinas. Sistema de ahorro energético. Fácil limpieza interior y exterior. Apta para el lavavajillas.

Cast aluminium body. Ergonomic plastic and silicone handles. Cast aluminium handles with silicone protectors included. Internally reinforced non-stick system. Suitable for all types of kitchens. Energy saving system. Easy internal and external cleaning. Dishwasher safe.

Corps en fonte d'aluminium. Manches ergonomiques en plastique et en silicone. Poignées en fonte d'aluminium, livré avec protections en silicone. Système antiadhésif renforcé intérieurement. Adapté à toutes les cuisinières. Système d'épargne énergétique. Intérieur et extérieur faciles à nettoyer. Adapté au lave-vaisselle.

Corpo in alluminio fuso. Manici ergonomici in plastica e silicone. Anse di alluminio fuso, protezioni in silicone comprese. Sistema antiaderente rinforzato internamente. Indicata per qualsiasi tipo di cucina. Sistema di risparmio energetico. Facile pulizia interna ed esterna. Indicata per il lavaggio in lavastoviglie.

Corpo de alumínio fundido. Pegas ergonômicas de plástico e silicone. Alças de alumínio fundido com protetores de silicone incluídos. Sistema antiaderente reforçado internamente. Adequada para todos os tipos de cozinhas. Sistema de economia de energia. Fácil limpeza interna e externa. Adequada para máquina de lavar louça.



Antiadherente Reforzado
Reinforced Non Stick Coating
Antiadhésif Renforcé
Antiaderente Rinforzato
Antiaderente Reforzado



Aluminio Fundido
Die Cast Aluminium
Fonte D'Aluminium
Alluminio Fuso
Alumínio Fundido



Cocinas de Gas // Gas Cooktops
Cuisinières à Gaz // Cucine a Gas
Fogão a Gás



Inducción // Induction
Induction // Induzione
Indução



Cocinas de Eléctricas // Electric Cooktops // Cuisinières Électriques
Cucine Elettriche // Fogões Elétricos.



Apto para Lavavajillas
Dishwasher Proof // Adapté Au Lave-Vaisselle // Adatto per il Lavaggio in Lavastoviglie
Adequado Para Lava-Louças



Cocinas de Cerámicas // Ceramic Cooktops // Cuisinières Céramiques
Cucine Ceramiche // Fogões Lerâmicos

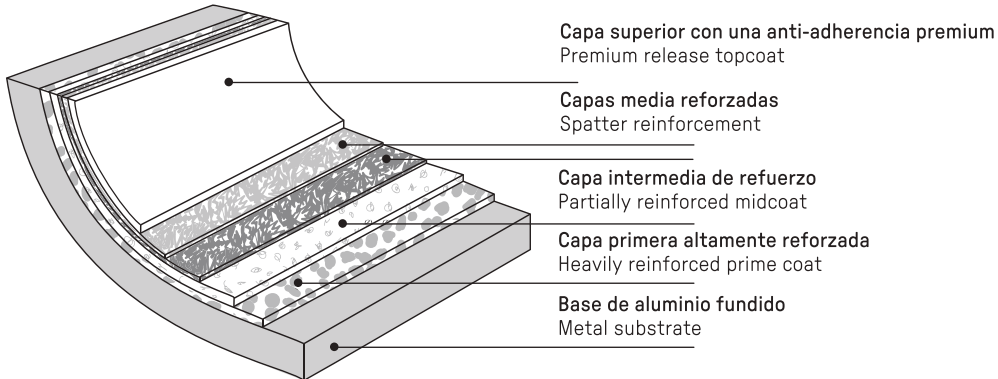

EXCELLENT RELEASE



SUPERIOR DURABILITY



MADE WITHOUT PFOA



MADE WITHOUT PFOS



REGULATORY COMPLIANT



SCRATCH RESISTANT



DISHWASHER SAFE



HEALTHFUL COOKING



EASY CLEAN

	Corbata	Sleeve	Fourreau Carton	Cartone Protettivo	Gravata Cartão
---	---------	--------	-----------------	--------------------	----------------



Libre de PFOA
Free PFOA // Sans
PFOA // Senza PFOA
Livre de PFOA



16 cm
0,74 l

718000



Sartén Antiadherente // Non-Stick
Fry Pan // Poêle-Antiadhésive
Padella Antiaderente // Frigideira
Antiaderente



18 cm
1 l

718100



Sartén Antiadherente // Non-Stick
Fry Pan // Poêle-Antiadhésive
Padella Antiaderente // Frigideira
Antiaderente



20 cm
1,3 l

718200



Sartén Antiadherente // Non-Stick
Fry Pan // Poêle-Antiadhésive
Padella Antiaderente // Frigideira
Antiaderente



22 cm
1,7 l

719800



Sartén Antiadherente // Non-Stick
Fry Pan // Poêle-Antiadhésive
Padella Antiaderente // Frigideira
Antiaderente

	Corbata	Sleeve	Fourreau Carton	Cartone Protettivo	Gravata Cartão
--	---------	--------	-----------------	--------------------	----------------



Libre de PFOA
Free PFOA // Sans
PFOA // Senza PFOA
Livre de PFOA



24 cm
2 l

718300

 24cm / 9,4"
19,2cm / 7,5"

Sartén Antiadherente // Non-Stick Fry Pan // Poêle-Antiadhésive Padella Antiaderente // Frigideira Antiaderente



26 cm
2,6 l

718400

 26cm / 10,2"
20,9cm / 8,2"

Sartén Antiadherente // Non-Stick Fry Pan // Poêle-Antiadhésive Padella Antiaderente // Frigideira Antiaderente



28 cm
3,1 l

718500

 28cm / 11"
22,9cm / 9"

Sartén Antiadherente // Non-Stick Fry Pan // Poêle-Antiadhésive Padella Antiaderente // Frigideira Antiaderente



30 cm
3,9 l

718600

 30cm / 11,8"
24,7cm / 9,7"

Sartén Antiadherente // Non-Stick Fry Pan // Poêle-Antiadhésive Padella Antiaderente // Frigideira Antiaderente

	Corbata	Sleeve	Fourreau Carton	Cartone Protettivo	Gravata Cartão
---	---------	--------	-----------------	--------------------	----------------



16 cm
1,2 l

719000

 16cm / 6,2"
11,4cm / 4,5"

Cazo // Sauce Pan // Casserole
Pentolino // Caçarola Com Rabo



18 cm
1,6 l

719100

 18cm / 7"
13,4cm / 5,2"

Cazo // Sauce Pan // Casserole
Pentolino // Caçarola Com Rabo



20 cm
2,2 l

719200

 20cm / 7,8"
15,2cm / 6"

Cazo // Sauce Pan // Casserole
Pentolino // Caçarola Com Rabo

	Caja	Box	Boite	Scatola	Caixa
---	------	-----	-------	---------	-------



24cm
4 l

718700

 24cm / 9,4"
19cm / 7,5"

Cacerola // Casserole // faitout
Casseruola // Caçarola



28 cm
6,6 l

718800

 28cm / 11"
22cm / 8,6"

Cacerola // Casserole // faitout
Casseruola // Caçarola



32 cm
9,3 l

718900

 32cm / 12,5"
24cm / 9,4"

Cacerola // Casserole // faitout
Casseruola // Caçarola

	Corbata	Sleeve	Fourreau Carton	Cartone Protettivo	Gravata Cartão
--	---------	--------	-----------------	--------------------	----------------



Libre de PFOA
Free PFOA // Sans
PFOA // Senza PFOA
Livre de PFOA



24x24 cm
1,1 l

719300

 24x24cm / 9,4x9,4"
19x19cm / 7,5x7,5"

Grill Antiaderente // Non-Stick
Grill // Gril Anti-Adhésif // Grill
Antiaderente // Grelhador
Antiaderente



28x28 cm
2,3 l

719400

 28x28cm / 11x11"
22x22cm / 8,6x8,6"

Grill Antiaderente // Non-Stick
Grill // Gril Anti-Adhésif // Grill
Antiaderente // Grelhador
Antiaderente

	Caja	Box	Boîte	Scatola	Caixa
--	------	-----	-------	---------	-------



34x26 cm
2,2 l

719500

 34x26cm / 13,3x11"

Grill Antiaderente // Non-Stick
Grill // Gril Anti-Adhésif // Grill
Antiaderente // Grelhador
Antiaderente

719600

Para ref: 718700 // 718800 // 719500

8,5x6,5cm/3,3x2,5"

719700

Para ref: 7189

10x7cm/3,9x2,7"

Asas Silicona (1 par) // Silicone
Handles (1 pair) // Poignées
Silicone (1 paire) // Manice Silicone
(1 paio) // Asas Silicone (1Par)



	Corbata	Sleeve	Fourreau Carton	Cartone Protettivo	Gravata Cartão
---	---------	--------	-----------------	--------------------	----------------



Libre de PFOA
Free PFOA // Sans
PFOA // Senza PFOA
Livres de PFOA



20-24 cm

7198000

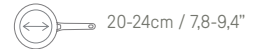

Set de sartenes // Frying Pan Set
Set 2 Poêle // Set 2 Padelle // Set
2 Frigideiras

	Caja	Box	Boîte	Scatola	Caixa
---	------	-----	-------	---------	-------



x4

697900

Bateria de Cocina // Cookware Set
Batterie de Cuisine // Batteria da
Cucina // Conjunto de Panelas

4 Piezas // 4 Pieces // 4 Pièces
4 Pezzi // 4peças



719100
18/7"



718700
24cm/9,4"



718800
28cm/11"



719500
34x26cm//13,3x11"





ÚTILES PROFESIONALES



PROFESSIONAL UTENSILS
USTENSILES PROFESSIONNELS
UTENSILI PROFESSIONALI
FERRAMENTAS PROFISSIONAIS





	Caja	Box	Boîte	Scatola	Caixa
	Acero Inoxidable NITRUM® Polipropileno	NITRUM® Stainless Steel Polypropylene	Acier Inoxydable NITRUM® Polypropylène	Acciaio Inossidabile NITRUM® Polipropilene	Aço Inoxidável NITRUM® Polipropileno



277100



Electricista // Electrician Knife
C. Électricien // Coltello Eletttricista
Elettricista



	Display	Display	Carte	Display	Display
	Acero Inoxidable Polipropileno	Stainless Steel Polypropylene	Acier Inoxydable Polypropylène	Acciaio Inossidabile Polipropilene	Aço Inoxidável Polipropileno



790200



Gubia // Gouge // Gouge
Sgorbia // Goiva

	Display	Display	Carte	Display	Display
	Acero Inoxidable Acero Inoxidable	Stainless Steel Stainless Steel	Acier Inoxydable Acier Inoxydable	Acciaio Inossidabile Acciaio Inossidabile	Aço Inoxidável Aço Inoxidável

795000



Lira de Queso // Cheese Lira
Lyre à Fromage // Taglia Formaggio
a Filo // Lira de Queijo





795100



Lira de Queso // Cheese Lira
Lyre à Fromage // Taglia Formaggio
a Filo // Lira de Queijo



	Caja	Box	Boîte	Scatola	Caixa
	Acero Inoxidable Polietileno	Stainless Steel Polyethylene	Acier Inoxydable Polyéthylène	Acciaio Inossidabile Polietilene	Aço Inoxidável Polietileno



791600





Corta Bacalao-Pan // Codfish - Bread Cutting Knife // C. Coupe Pain // Taglia-Baccalà - Pane Corta-Bacalhau - Pão



689900



Tabla Panera // Bread Cutting Board // Planche Coupe Pain Tagliere Taglia Pane // Tábua de Cortar Pão

	Caja	Box	Boîte	Scatola	Caixa
	Acero Inoxidable Acero Inoxidable	Stainless Steel Stainless Steel	Acier Inoxydable Acier Inoxydable	Acciaio Inossidabile Acciaio Inossidabile	Aço Inoxidável Aço Inoxidável



790500



Escamador de pescado // Scaling Knife // Écailleur // Squama-Pesce Escalador Peixe

	Caja	Box	Boîte	Scatola	Caixa
	Acero Inoxidable Acero Inoxidable	Stainless Steel Stainless Steel	Acier Inoxydable Acier Inoxydable	Acciaio Inossidabile Acciaio Inossidabile	Aço Inoxidável Aço Inoxidável



790600

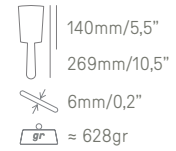

Aplastador de Filetes // Meat tenderizer // Batte à Cotelette Batticarne // Amaciador Carne

	Caja	Box	Boîte	Scatola	Caixa
	Acero Inoxidable Polioximetileno (POM)	Stainless Steel Polyoxymethylene (POM)	Acier Inoxydable Polyoxyméthylène (POM)	Acciaio Inossidabile Polioximetileno (POM)	Aço Inoxidável Polioximetileno (POM)



790800

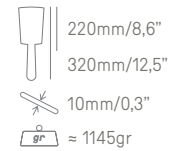

Aplastador de Filetes // Meat tenderizer // Batte à Cotelette Batticarne // Amaciador Carne

	Caja	Box	Boîte	Scatola	Caixa
	Acero Inoxidable Polipropileno	Stainless Steel Polypropylene	Acier Inoxydable Polypropylène	Acciaio Inossidabile Polipropilene	Aço Inoxidável Polipropileno



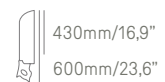

791800



Sierra Carnicero // Butcher Saw Scie Boucher // Segá da Macellaio Serra Carniceiro

GADGETS





	Caja	Box	Boîte	Scatola	Display
	Acero Inoxidable Polipropileno	Stainless Steel Polypropylene	Acier Inoxydable Polypropylène	Acciaio Inossidabile Polipropilene	Aço Inoxidável Polipropileno



277200



Abre Ostras // Oyster Knife
C. Ouvre Huîtres // Apri-Ostriche
Abre-Ostras



	Display	Display	Carte	Display	Display
	Acero Inoxidable Polipropileno	Stainless Steel Polypropylene	Acier Inoxydable Polypropylène	Acciaio Inossidabile Polipropilene	Aço Inoxidável Polipropileno



613600



Decorador Frutas
Fruit Decorator // Décorateur à
Fruits // Decoratore Frutta
Decorador Frutas

	Caja	Box	Boîte	Scatola	Caixa
	Acero Inoxidable ABS	Stainless Steel ABS	Acier Inoxydable ABS	Acciaio Inossidabile ABS	Aço Inoxidável ABS



780800



Mantequilla // Butter Knife
C. Beurre // Coltello burro //
Manteiga

	<p>Display</p> <p>Acero Inoxidable Polipropileno</p>	<p>Display</p> <p>Stainless Steel Polypropylene</p>	<p>Carte</p> <p>Acier Inoxydable Polypropylène</p>	<p>Display</p> <p>Acciaio Inossidabile Polipropilene</p>	<p>Display</p> <p>Aço Inoxidável Polipropileno</p>
---	--	---	--	--	--



613000

50mm/1,9"
156mm/6,1"
25mm /0,9"

Vaciador-Decorador // Melon Baller
Moule à Pomme // Scavino
Esvaziador-Decorado



613100

60mm/2,3"
165mm/6,4"
22-25mm /0,8-0,9"

Doble Vaciador // Double Melon Baller
Moule à Pomme double
Scavino doppio // Duplo
Esvaziador-Decorado



616600

65mm/2,5"
170mm/6,6"

Mondador Naranjas // Canal Knife
Canneleur d'orange // Pela-arance
Descascador Laranjas



612700

40mm/1,5"
150mm/5,9"

Mondador Naranjas // Canal Knife
Canneleur d'orange // Pela-arance
Descascador Laranjas



612200

90mm/3,5"
192mm/7,5"

Decorador // Decorating Knife
Décorateur // Coltello Decoratore
Decorador



612300

75mm/2,9"
185mm/7,2"

Descorazonador // Apple Corer
Vide Pomme // Coltello Tagliamela
Descaroçado

	<p>Display</p> <p>Acero Inoxidable Polipropileno</p>	<p>Display</p> <p>Stainless Steel Polypropylene</p>	<p>Carte</p> <p>Acier Inoxydable Polypropylène</p>	<p>Display</p> <p>Acciaio Inossidabile Polipropilene</p>	<p>Display</p> <p>Aço Inoxidável Polipropileno</p>
--	--	---	--	--	--



616800

117mm/4,6"
225mm/8,8"

Descorazonador // Apple Corer
Vide Pomme // Coltello Tagliamela
Descaroçado



612800

40mm/1,5"
145mm/5,7"

Rallador Limones // Decorating Zester
Zester // Canneler Zesteur
Rigalimoni // Ralador Limõe



613200

85mm/3,3"
190mm/7,4"

Rizador Mantequilla // Butter Curler
Curler // Coquilleur à Beurre
Arricia-burro // Modelador Manteiga



614200

90x20mm/3,5x0,7"
215mm/8,4"

Espátula // Spatula // Spatule
Spatola // Espátula



614300

220x35mm/8,6x1,3"
352mm/13,8"

Espátula // Spatula // Spatule
Spatola // Espátula



614400

280x35mm/11"x1,3"
402mm/15,8"

Espátula // Spatula // Spatule
Spatola // Espátula

	<p>Display</p> <p>Acero Inoxidable Polipropileno</p>	<p>Display</p> <p>Stainless Steel Polypropylene</p>	<p>Carte</p> <p>Acier Inoxydable Polypropylène</p>	<p>Display</p> <p>Acciaio Inossidabile Polipropilene</p>	<p>Display</p> <p>Aço Inoxidável Polipropileno</p>
---	--	---	--	--	--



613700

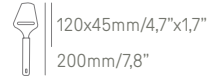

Corta Queso // Cheese plane
Coupe Fromage // Taglia-formaggio
Corta-Queijo



613800



Rallador Queso // Cheese Grater
Rape à Fromage // Grattugia
Ralador-Queijo



614500



Espátula Servir // Serving Spatula
// Spatule de Service // Spatola da
Servire // Espátula de Servir



614600



Espátula Servir // Serving Spatula
Spatule de Service // Spatola da
Servire // Espátula de Servir



614800

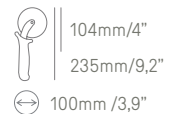

Corta Pizza // Pizza Cutter
Coupe Pizza // Tagliapizza
Corta Pizza

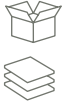
	Display	Display	Carte	Display	Display
	Acero Inoxidable	Stainless Steel	Acier Inoxydable	Acciaio Inossidabile	Aço Inoxidável



606200

300mm/11,8"



Pinza Emplatar // Plating Pincer
 Pince à Servir // Pinza Servire
 Pinças Servir



606300

200mm/7,8"



Pinza Emplatar // Plating Pincer
 Pince à Servir // Pinza Servire
 Pinças Servir



606500

140mm/5,5"



Pinza Emplatar // Plating Pincer
 Pince à Servir // Pinza Servire
 Pinças Servir

	Display	Display	Carte	Display	Display
	Acero Inoxidable 18/10	Stainless Steel 18/10	Acier Inoxydable 18/10	Acciaio Inossidabile 18/10	Aço Inoxidável 18/10



606100

120mm/4,7"



Pinza Jamón // Ham Pincer
 Pince à Jambon // Pinza Prosciutto
 Pinça Presunto





605100

100mm/3,9"



Pinza Jamón // Ham Pincer
 Pince à Jambon // Pinza Prosciutto
 Pinça Presunto

	Display	Display	Carte	Display	Display
	Acero Inoxidable	Stainless Steel	Acier Inoxydable	Acciaio Inossidabile	Aço Inoxidável



605000

110mm / 4,3"



Pinza Pescado // Fish Pincer
Pince à Arêtes // Pinza Pesce
Pinça Peixe



606400

185mm / 7,2"



Tenaza Marisco // Lobster Cracker
Pince Crustacés // Pinza Crostacei
Pinça Marisco



613300

250mm / 9,8"



Batidora Varilla // Whisk
Fouet // Frusta // Batedor de
Varetas



613400

300mm / 11,8"



Batidora Varilla // Whisk
Fouet // Frusta // Batedor de
Varetas

	Display Acero Inoxidable	Display Stainless Steel	Carte Acier Inoxydable	Display Acciaio Inossidabile	Display Aço Inoxidável
--	-----------------------------	----------------------------	---------------------------	---------------------------------	---------------------------

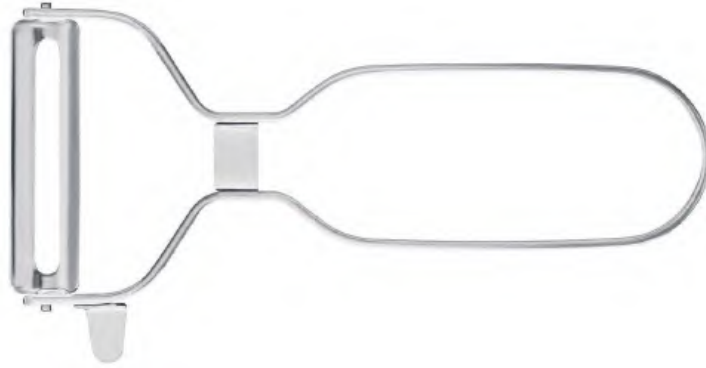

607000



55mm / 2,1"
 130mm / 5,1"

Utensilio Pelador // Peeler
 Éplucheur // Pelapatate
 Descascador

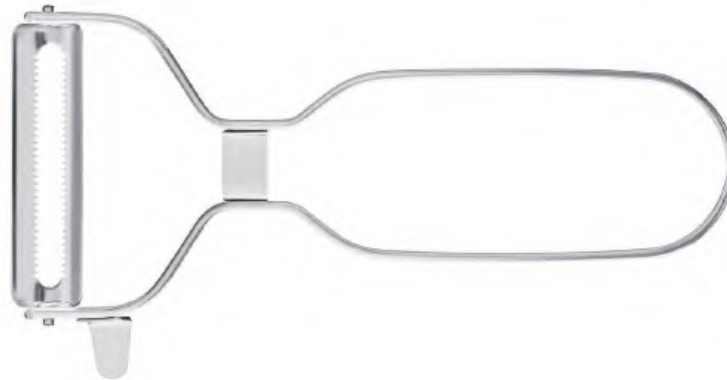

607100



55mm / 2,1"
 130mm / 5,1"

Utensilio Pelador Tomate // Tomate
 Peeler // Éplucheur Tomate
 Pelapomodoro // Descascador
 Tomate

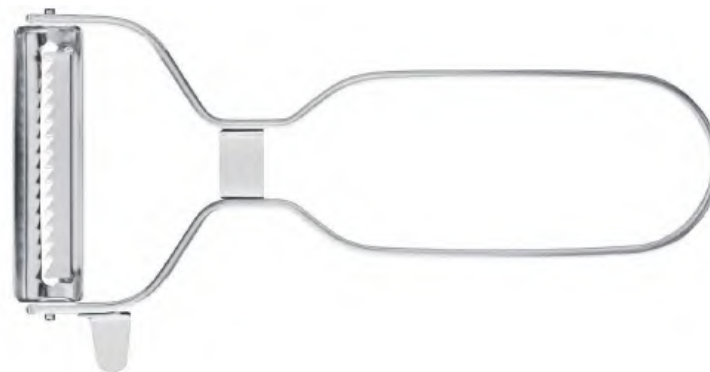



607200



55mm / 2,1"
 130mm / 5,1"

Cortador de Juliana // Julienne
 Cutter // Éplucheur Julienne
 Tagliatore Julienne // Descascador
 Juliana

	Caja	Box	Boîte	Scatola	Caixa
	Acero Inoxidable Polipropileno (PP)	Stainless Steel Polypropylene (PP)	Acier Inoxydable Polypropylène (PP)	Acciaio Inossidabile Polipropilene (PP)	Aço Inoxidável Polipropileno (PP)



607300





Utensilio Pelador // Peeler
Éplucheur // Pelapatate
Descascador

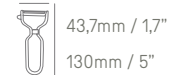

607420



Utensilio Pelador Tomate // Tomato
Peeler // Éplucheur Tomate
Pelapomodoro // Descascador
Tomate



	Caja Expositora	Display Box	Boîte Présentoir	Scatola Expo	Caixa Expositora
	Acero Inoxidable NITRUM® Polipropileno (PP)	NITRUM® Stainless Steel Polypropylene (PP)	Acier Inoxydable NITRUM® Polypropylène (PP)	Acciaio Inossidabile NITRUM® Polipropilene (PP)	Aço Inoxidável NITRUM® Polipropileno (PP)

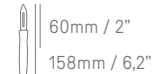

181300



Mondador // Potato Peeler
Éplucheur // Spelucchino
Descascador

	Display	Display	Carte	Display	Display
	Acero Inoxidable Polipropileno (PP)	Stainless Steel Polypropylene (PP)	Acier Inoxydable Polypropylène (PP)	Acciaio Inossidabile Polipropilene (PP)	Aço Inoxidável Polipropileno (PP)



612100



Mondador // Potato Peeler
Éplucheur // Pelapatate
Descascador

	Display	Display	Carte	Display	Display
	Silicona Polipropileno (PP)	Silicone Polypropylene (PP)	Silicone Polypropylène (PP)	Silicone Polipropilene (PP)	Silicone Polipropileno (PP)



617100

200mm / 7,8"



Brocha Pastelero // Pastry Brush
Pinceau à Pâtisserie // Pennello
Dolci // Brocha Pasteleiro

	Display	Display	Carte	Display	Display
	Silicona Metal	Silicone Metal	Silicone Métal	Silicone Metallo	Silicone Metal



617200

286mm / 11,2"



Lengua Silicona Negro // Silicone
Spatula Black // Maryse Silicone
Noir // Leccapentola Nero
Espátula Silicone Preto

UTENSILS
USTENSILES
UTENSILI
FERRAMENTAS



UTENSILIOS



	<p>Display</p> <p>Acero Inoxidable 304 Silicona</p>	<p>Display</p> <p>304 Stainless Steel Silicone</p>	<p>Carte</p> <p>Acier Inoxydable 304 Silicone</p>	<p>Display</p> <p>Acciaio Inossidabile 304 Silicone</p>	<p>Display</p> <p>Aço Inoxidável 304 Silicone</p>
--	---	--	---	---	---



685000

331mm / 13"



Espátula // Espátula // Spatula
Maryse // Spatola // Espátula



685200

337mm / 13,2"



Cuchara Pasta // Pasta Server
Cuillère Spaghetti // Cucchiaino di
Pasta // Colher Para Massa



685300

339mm / 13,3"



Espátula Ranurada // Slotted
Turner // Spatule Ajourée
Spatola Scanalata // Espátula con
Fessure



NEW

685700

338mm / 13,3"



Espátula // Espátula // Spatula
Spatule // Spatola // Espátula



685500

350mm / 13,7"



Espumadera // Skimmer
Écumoire // Schiumarola
Espumadeira

	Display Acero Inoxidable 304 Silicona	Display 304 Stainless Steel Silicone	Carte Acier Inoxydable 304 Silicone	Display Acciaio Inossidabile 304 Silicone	Display Aço Inoxidável 304 Silicone
--	---	--	---	---	---



685100

330mm / 12,9"



Cuchara // Spoon // Cuillère
Cucchiaio // Colher



685400

323mm / 12,7"



Cazo // Ladle // Louche // Mestolo
Concha



685600

300mm / 11,8"



Pinzas de Cocina // Kitchen Tongs
Pinze da Cucina // Pince de Cuisine
Pinças de Cozinha

	Caja Acero Inoxidable ABS	Box Stainless Steel ABS	Boîte Acier Inoxydable ABS	Scatola Acciaio Inossidabile ABS	Caixa Aço Inoxidável ABS
--	---------------------------------	-------------------------------	----------------------------------	--	--------------------------------



793100

| 280mm / 11"

↔ 150mm / 5,9"

Portarrollos Cocina // Paper Towel
Holder // Porte Rouleau Papier
Portarrotoli // Porta-Rolos

	Caja Regalo	Gift Box	Boîte Cadeau	Scatola Regalo	Caixa de Oferta
	Aleación de Zinc	Zinc Alloy	Alliage de Zinc	Lega di Zinco	Liga de Zinco



603000

160mm / 6,2"



Cascañueces // Cascanueces
Nut & Sea Food Cracker // Casse
Noix // Schiaccianoci // Quebra-
Nozes



603500

190mm / 7,4"



Prensa Ajos // Garlic Press
Presse Ail // Spremiaglio
Espresmedor de Alhos



603600

190mm / 7,4"



Abrelatas // Can Opener
Ouvre Boîte // Aprilattine
Abridor de latas



604500

Juego 5 Pzas. // 5 Pc. Set
Jeu 5 Pièces // Set 5 Pezzi
Jogo Gadgets

ACCESSORIES
COMPLÉMENTS
COMPLEMENTI
COMPLEMENTOS

COMPLEMENTOS





AFILADORES

Sharpeners // Aiguiseurs
Affilatori // Afiadores

PÁG 289



SOPORTES

Knife Holder // Blocs
Couteaux // Porta Coltelli
Suporte Facas

PÁG 304



CHAIRAS

Sharpening Steels // Fusils
Acciaini Affilatori // Fuzís

PÁG 292



SOPORTES MÁGNÉTICOS

Magnetic racks // Barres
Aimantées // Suportes
Magnéticos

PÁG 309



GUANTES DE PROTECCIÓN

Safety Gloves // Gants de
Protection // Guanti Antitaglio
Luva de Proteção

PÁG 296



SACACORCHOS

Corkscrew // Tire-Bouchon
Cavatappi // Saca-Rolhas

PÁG 312



TABLAS

Cutting Boards // Planches à
Découper // Taglieri // Tábuas
de Cortar

PÁG 298



SOPORTES PARA JAMÓN

Han Holder // Supports Jambon
Supporto Prosciutto // Suporte
Para Presunto

PÁG 315



BOLSAS PARA CUCHILLOS

Knives Roll Bag // Trousses
Couteaux // Borsa Portacoltelli
Saco para Facas

PÁG 301



EXPOSITORES

Point of Sale Displays // Pre-
sentoirs // Expositori // Expo-
sitores

PÁG 317



AFILADORES

SHARPENERS
AIGUISEURS
AFFILATORI
AFIADORES

Los afiladores son esenciales para la seguridad en la cocina; mantienen los cuchillos en afilados, asegurando cortes limpios y minimizando el esfuerzo y el riesgo de accidentes.

Sharpeners are essential for kitchen safety; they keep knives sharp, ensuring clean cuts and minimizing effort and the risk of accidents.

Les aigiseurs sont essentiels pour la sécurité en cuisine ; ils maintiennent les couteaux aiguisés, assurant des coupes nettes et minimisant l'effort et le risque d'accidents.

Gli affilatori sono essenziali per la sicurezza in cucina; mantengono i coltelli affilati, garantendo tagli puliti e minimizzando lo sforzo e il rischio di incidenti.

Afiadores são essenciais para a segurança na cozinha; mantêm as facas afiadas, garantindo cortes limpos e minimizando o esforço e o risco de acidentes.

Afilado Perfecto

Perfect Sharpening · Affûtage Parfait · Affilatura Perfetta · Afição perfeita.

Precisión de Uso



Precision of Use · Précision d'Utilisation · Precisione d'Uso · Precisão de Uso.

Uso Rápido e Intuitivo

Quick and intuitive Use · Utilisation Rapide et Intuitive
Uso Rapido e Intuitivo · Uso Rápido e Intuitivo.

Mantenimiento Simple



Simple Maintenance · Entretien Facile · Manutenzione
Semplice · Manutenção Simples.

	Caja	Box	Boîte	Scatola	Caixa
	ABS	ABS	ABS	ABS	ABS



610000

Afilador Profesional ABS
 Professional Sharpener ABS
 Aiguiseur Professionnel ABS
 Affilatore Prof. ABS
 Afiador Profissional ABS

	Blister	Blister	Blister	Blister	Blister
	Plástico	Plastic	Plastique	Plastico	Plástico



610200

Afilador Prof. Bolsillo
 Professional Pocket Sharpener
 Aiguiseur Professionnel Poche
 Affilatore Prof. Tasca
 Afiador Profissional Bolso

	Caja	Box	Boîte	Scatola	Caixa
	ABS + TPE Rodillos Cerámico y Carburo	ABS + TPE Carbide and Ceramic Rollers	ABS + TPE Rouleaux Céramique et Carbure	ABS + TPE Rulli in Ceramica e Carburo	ABS + TPE Rolos de cerâmica e de carboneto



610600

Afilador ABS // Sharpener ABS
 Aiguiseur ABS // Affilatore ABS
 Afiador de Mão ABS

	Caja	Box	Boîte	Scatola	Caixa
	ABS Rodillos Recubiertos Diamante	ABS Diamond-Coated Rolls	ABS Rouleaux Revêtement Diamant	ABS Rulli Rivestiti di Diamante	ABS Rôlos Revestidos com Diamante



603900

Afilador Eléctrico // Electric Knife Sharpener // Aiguseur Electrique
Affilatore Elettrico // Afiador Elétrico

	Caja	Box	Boîte	Scatola	Caixa
	Acero Inoxidable Rodillos Recubiertos Diamante	Stainless Steel Diamond-Coated Rolls	Acier Inoxydable Rouleaux Revêtement Diamant	Acciaio Inossidabile Rulli Rivestiti di Diamante	Aço Inoxidável Rôlos Revestidos com Diamante



610700

Máquina Afiladora Profesional
Professional Sharpening Machine
Machine d'Aiguisage Professionnelle
Macchina Affilatrice Professionale
Máquina Afiadora Profissional



CHAIRAS

SHARPENING STEELS

FUSILS

ACCIAINI

FUZIS

Los cuchillos sufren un fuerte desgaste debido al uso cotidiano. La utilización de la chaira garantiza el mantenimiento del filo y alarga su vida útil.

Knives undergo heavy wear from daily use. Using a sharpening steel ensures the maintenance of the edge and prolongs its useful life.

Les couteaux subissent une forte usure due à leur utilisation quotidienne. L'utilisation d'un fusil à aiguiser garantit le maintien du tranchant et prolonge leur durée de vie.

I coltelli subiscono un forte usura a causa dell'uso quotidiano. L'utilizzo di una chaira garantisce il mantenimento del filo e ne allunga la vita utile. As facas sofrem um forte desgaste devido ao uso diário. O uso de uma chaira garante a manutenção do fio e prolonga sua vida útil.



Materiales Resistentes

Resistant materials · Matériaux résistants · Materiali Resistenti
Materiais Resistentes.

Superficie Texturizada

Textured surface · Surface Texturée · Superficie Testurizzata
Superfície Texturizada.

Uso Seguro

Safe Use · Utilisation Sûre · Uso Sicuro · Uso Seguro.

10 Años de Garantía

10-Year Warranty · Garantie 10 Ans · Garanzia 10 Anni · Garantia
de 10 Anos.

 	Caja - 279200, 279400 Estuche - 279202	Box - 279200, 279400 Case - 279202	Boîte - 279200, 279400 Étui - 279202	Scatola - 279200, 279400 Astuccio - 279202	Caixa - 279200, 279400 Estojo - 279202
	Acero al Carbono Recubierto de Diamante Polipropileno	Carbon Steel Coated Diamond-coated Polypropylene	Acier au Carbone Revêtement diamant Polypropylène	Acciaio al Carbonio Rivestito di diamante Polipropilene	Aço Carbono Revestido de diamante Polipropileno





279200/ 279202

 280mm / 11"
 431mm / 16,9"
 17mm / 0,6"

Chaira Diamante Ovalada
Diamond Sharpening Steel // Fusil
Diamant Mèche Ovale // Acciaio
al Diamante // Afiador de Aço
(Oval, Revestida de Diamante)



279400

 240mm / 9,4"
 365mm / 14,3"
 10mm / 0,3"

Chaira Diamante
Diamond Sharpening Steel
Fusil Diamant Mèche Ronde
Acciaio al Diamante // Afiador de
Aço (Revestida de Diamante)

 	Caja - 278100, 278400, 278200 Estuche - 278138	Box- 278100, 278400, 278200 Case - 278138	Boîte -278100, 278400, 278200 Étui - 278138	Scatola -278100, 278400, 278200 Astuccio - 278138	Caixa - 278100, 278400, 278200 Estojo - 278138
	Acero al Carbono Recubierto de Diamante Polipropileno	Carbon Steel Coated Diamond-Coated Polypropylene	Acier au Carbone Revêtement Diamant Polypropylène	Acciaio al Carbonio Rivestito di Diamante Polipropilene	Aço Carbono Revestido de Diamante Polipropileno



278100/278138

 230mm / 9,0"
 375mm / 14,7"
 10mm / 0,3"

Chaira // Sharpening Steel
Fusil Mèche Ronde // Acciaio
Afiador de Aço Preto



278400

 250mm / 9,8"
 385mm / 15,1"
 10mm / 0,3"

Chaira // Sharpening Steel
Fusil Mèche Ronde // Acciaio
Afiador de Aço Preto



278200

 250mm / 9,8"
 375mm / 14,7"
 13mm / 0,5"

Chaira // Sharpening Steel
Fusil Mèche Ronde // Acciaio
Afiador de Aço Preto

	Caja Acero al Carbono Cromado Polipropileno	Box Carbon Steel Chromium Coated Polypropylene	Boîte Acier au Carbone Chromé Polypropylène	Scatola Acciaio al Carbonio Cromato Polipropilene	Caixa Aço carbono cromado Polipropileno
--	--	---	--	--	--



782100

 230mm / 9"
 335mm / 13,8"
 10mm / 0,3"

Chaira // Sharpening Steel
 Fusil Mèche Ronde // Acciaino
 Afiador de Aço Preto



278510

 300mm / 11,8"
 440mm / 17,3"
 13mm / 0,5"

Chaira de Grão Fino // Fine Grain Honing Steel // Fusil Taillage Fin Mèche Ronde // Affilatoio a Grana Fine // Afiador de Grão Fino

● 278511 ● 278512 ● 278513 ○ 278514 ● 278515





279010

 300mm / 11,8"
 440mm / 17,3"
 17mm / 0,6"

Chaira de Grão Fino Ovalada
 Fine Grain Oval Honing Steel
 Fusil Taillage Fin Mèche Ovale
 Affilatoio Ovale a Grana Fine
 Afiador de Grão Fino Oval



279600

 300mm / 11,8"
 440mm / 17,3"
 20mm / 0,7"

Chaira de Grão Extra Fino Ovalada // Extra Fine Grain Oval Honing Steel // Fusil Taillage Extra-Fin Mèche Ovale // Affilatoio ovale a Grana Super Fine // Afiador de Grão Extra Fino Oval

● 279623



279900

 350mm / 13,7"
 490mm / 19,3"
 20mm / 0,7"

Chaira de Grão Extra Fino Ovalada // Extra Fine Grain Oval Honing Steel // Fusil Taillage Extra-Fin Mèche Ovale // Affilatoio ovale a Grana Super Fine // Afiador de Grão Extra Fino Oval

● 279923

Afilar

AFILAR UN CUCHILLO

SHARPENING A KNIFE

AIGUISER UN COUPEAU

COME AFFILARE UN COLTELLO

AFIAR UMA FACA

Si mantiene el filo del cuchillo afilado ayudará a que cumpla su función adecuadamente y alargará la vida de su producto. Lo más aconsejable es el uso periódico de chairas o aceros para el mantenimiento de los filos de sus cuchillos:

Coloque la hoja del cuchillo y la chaira formando un ángulo agudo (20°).

El brazo que sujeta la chaira no debe moverse, y la otra mano apoyará ligeramente la hoja sobre la chaira y la deslizará sobre ésta manteniendo el ángulo.

Pase repetidamente la hoja del cuchillo sobre la chaira.

Afile el otro lado de la hoja repitiendo los mismos movimientos, esta vez por el otro lado de la chaira.

Lo ideal es alternar las pasadas del filo por la chaira, para conseguir una perfecta simetría en un lado sin cargar el otro.

Keeping the blade's cutting edge sharpened will help the knife to work properly and safely and it will last much longer.

Hold the blade at a 20° angle against the honing steel.

Keep the arm that is holding the steel steady and swipe the blade lightly over the steel keeping the angle at 20°.

Sharpen the other side of the blade as before, this time using the other side of the honing steel.

Give each side of the knife an equal number of swipes (about 20).

The ideal is to swipe both sides of the blade alternately to get a perfectly even sharpness on both sides of the blade.

Entretenir le fil du couteau permettra à celui-ci de répondre à sa fonction première qui est de couper et allongera sa durée de vie.

Le meilleur conseil est d'utiliser régulièrement un fusil pour maintenir le fil de son couteau:

En positionnant la lame à un angle de 20° par rapport à la mèche, la main qui tient le fusil ne doit pas bouger et l'autre main, appuyant légèrement la lame sur la mèche du fusil, laisse glisser celle-ci en maintenant cet angle.

Passer plusieurs fois la lame du couteau sur le fusil.

Aiguiser l'autre côté de la lame en répétant le même mouvement, mais cette fois-ci de l'autre côté de la mèche du fusil.

L'idéal est d'alterner les passages du fil sur la mèche du fusil, pour obtenir une parfaite symétrie de l'aiguisage de part et d'autre de la lame.

Mantenere il filo ad un coltello contribuisce al buon funzionamento del prodotto ed alla sua durata nel tempo.

Consigli per un utilizzo ottimale per una buona affilatura con acciaio: Posizionate la lama del coltello e l'acciaio in modo da formare un angolo acuto a 20°.

Il braccio e la mano che sostiene l'acciaio non deve muoversi, mentre l'altra mano appoggerà leggermente la lama sull'acciaio e la farà scivolare mantenendo l'angolo come sopra indicato.

Ripetere l'operazione di passaggio della lama sull'acciaio più volte.

Affilate l'altro lato della lama ripetendo i medesimi movimenti.

L'affilatura ideale si ottiene ripassando più volte alternativamente i due lati della lama sull'acciaio.

Manter o gume da sua faca afiado ajuda a desempenhar corretamente a sua função e prolonga a vida útil do seu produto. O mais aconselhável é utilizar periodicamente o fusil para manter o fio das suas facas: Colocar a lâmina da faca e o fusil num ângulo agudo (20°). O braço que segura o fusil não deve mover-se e a outra mão deve apoiar ligeiramente a lâmina no fusil e deslizará-la sobre o aço de afiar, mantendo o ângulo. Passar repetidamente a lâmina da faca sobre o fusil. Afile o outro lado da lâmina repetindo os mesmos movimentos, desta vez no outro lado do fusil. O ideal é alternar as passagens da lâmina sobre o fusil para obter uma simetria perfeita em ambos os lados.

has context menu





GUANTES DE PROTECCIÓN

SAFETY GLOVES
GANTS PROTECTION
GUANTI ANTITAGLIO
LUA DE POTEÇÃO

El uso de guantes protectores es fundamental al manejar herramientas cortantes, previniendo cortes y lesiones en manos y antebrazos. Proporcionan protección variada y se adaptan a cada necesidad.

The use of protective gloves is fundamental when handling sharp tools, preventing cuts and injuries to hands and forearms. They provide varied protection and adapt to every need.

L'utilisation de gants de protection est fondamentale lors de la manipulation d'outils tranchants, prévenant les coupures et les blessures aux mains et avant-bras. Ils offrent une protection variée et s'adaptent à chaque besoin.

L'uso di guanti protettivi è essenziale nella manipolazione di strumenti affilati per prevenire tagli e lesioni alle mani. Offrono protezione variabile e si adattano ad ogni esigenza.

O uso de luvas protetoras é fundamental ao manusear ferramentas cortantes, prevenindo cortes e lesões em mãos e antebraços. Proporcionam proteção variada e se adaptam a cada necessidade.

Uso Ambidiestro

Ambidextrous Use • Utilisation Ambidextre • Uso Ambidestro • Uso Ambidestro.

Multiples Tallas Disponibles



Multiple Sizes available • Plusieurs Tailles Disponibles • Diverse Taglie Disponibili
Vários Tamanhos Disponíveis.

Protege de Lesiones

Protects from Injuries • Protège des Blessures • Protegge dalle Lesioni • Protege de Lesões.

Refuerzos Flexibles en los Puños

Flexible Reinforcements on the Cuffs • Renforts Flexibles aux poignets • Rinforzi Flessibili Sui Polsini • Reforços Flexíveis nos Punhos.

	Caja	Box	Boîte	Scatola	Caixa
	Acero Inoxidable	Stainless Steel	Acier Inoxydable	Acciaio Inossidabile	Aço Inoxidável



615000



Guante Malla // Chainmail Glove
Gant en Maille // Guanto In Maglia
Luva de Proteção



615100



Guante Malla // Chainmail Glove
Gant en Maille // Guanto In Maglia
Luva de Proteção



615200

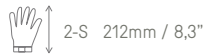

Guante Malla // Chainmail Glove
Gant en Maille // Guanto In Maglia
Luva de Proteção



615300



Guante Malla // Chainmail Glove
Gant en Maille // Guanto In Maglia
Luva de Proteção



615400

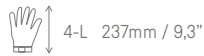

Guante Malla // Chainmail Glove
Gant en Maille // Guanto In Maglia
Luva de Proteção



TABLAS

Diseñadas para la rutina culinaria, nuestras tablas ofrecen manejo cómodo, almacenaje sencillo con orificio incorporado. Superficie para cortar sin dañar el filo del cuchillo. Resistente para cortes precisos y elegante presentación de alimentos.

Designed for the culinary routine, our boards offer comfortable handling, simple storage with an incorporated hole. A surface for cutting without damaging the knife's edge. Durable for precise cuts and elegant food presentation.

Conçues pour une utilisation quotidienne en cuisine, nos planches offrent une prise en main confortable, un rangement pratique grâce à leur ouverture intégrée. Une surface de découpe préservant le tranchant du couteau. Robustes pour des coupes précises et une présentation élégante des aliments.

Progettate per la routine culinaria, le nostre tavole offrono una maneggevolezza confortevole, un'immagazzinamento semplice con un foro incorporato. Una superficie per tagliare senza danneggiare il filo del coltello. Resistente per tagli precisi ed elegante presentazione dei cibi.

Desenhadas para a rotina culinária, nossas tábuas oferecem manuseio confortável, armazenamento simples com um orifício incorporado. Superfície para cortar sem danificar o fio da faca. Resistente para cortes precisos e elegante apresentação de alimentos.

Superficie protectora del Filo

Edge-Protecting Surface • Surface Protectrice du Fil • Superficie Protettiva del Filo • Superfície Protetora do Fio.

Orificio para Almacenamiento

Storage Hole • Trou Pour Rangement • Foro per l'immagazzinamento • Orificio para Armazenamento.

Limpieza Rápida y Sencilla

Quick and Easy Cleaning • Nettoyage Rapide et Simple • Pulizia Rapida e Semplice • Limpeza Rápida e Simples.

Variedad de Colores

Variedad de Colores • Variety of Colors • Variété de Couleurs • Varie colorazioni • Variedade de Cores.

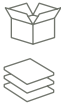
	Caja	Box	Boîte	Scatola	Caixa
	Fibra de Celulosa y Resina	Resin and Cellulose Fibre	Fibre de Cellulose et Résine	Fibra di Cellulosa e Resina	Fibra de Celulose e Resina



765000

240x140mm / 9x5"
6,5mm / 0,2"

Tabla de corte Mármol
Cutting Board Marble
Planche à Découper Marbre
Tagliere Marmol
Tábua de Corte Mármore



691510

240x140mm / 9x5"
6,5mm / 0,2"

Tabla de Corte Negra
Cutting Board Black
Planche à Découper Noire
Tagliere Nero
Tábua de Corte Preta



708000

240x140mm / 9x5"
6,5mm / 0,2"

Tabla de Corte Natural
Cutting Board Natural
Planche à Découper Naturel
Tagliere Naturale
Tábua de Corte Natural



765100

330x230mm / 13x9"
6,5mm / 0,2"

Tabla de corte Mármol
Cutting Board Marble
Planche à Découper Marbre
Tagliere Marmol
Tábua de Corte Mármore



691610

330x230mm / 13x9"
6,5mm / 0,2"

Tabla de Corte Negra
Cutting Board Black
Planche à Découper Noire
Tagliere Nero
Tábua de Corte Preta



708100

330x230mm / 13x9"
6,5mm / 0,2"

Tabla de Corte Natural
Cutting Board Natural
Planche à Découper Naturel
Tagliere Naturale
Tábua de Corte Natural



765200

377x227mm / 15x11"
6,5mm / 0,2"

Tabla de corte Mármol
Cutting Board Marble
Planche à Découper Marbre
Tagliere Marmol
Tábua de Corte Mármore



691710

377x227mm / 15x11"
6,5mm / 0,2"

Tabla de Corte Negra
Cutting Board Black
Planche à Découper Noire
Tagliere Nero
Tábua de Corte Preta



708200

377x227mm / 15x11"
6,5mm / 0,2"

Tabla de Corte Natural
Cutting Board Natural
Planche à Découper Naturel
Tagliere Naturale
Tábua de Corte Natural



765300

427x327mm / 17x13"
6,5mm / 0,2"

Tabla de corte Mármol
Cutting Board Marble
Planche à Découper Marbre
Tagliere Marmol
Tábua de Corte Mármore



691810

427x327mm / 17x13"
6,5mm / 0,2"

Tabla de Corte Negra
Cutting Board Black
Planche à Découper Noire
Tagliere Nero
Tábua de Corte Preta



708300

427x327mm / 17x13"
6,5mm / 0,2"

Tabla de Corte Natural
Cutting Board Natural
Planche à Découper Naturel
Tagliere Naturale
Tábua de Corte Natural

i

Resistencia al lavavajillas / Dishwasher safe / Compatible lave-vaisselle / Adatto per lavastoviglie / Resistente à máquina de lavar loiça
No daña los cuchillos / Knife friendly / N'émousse pas le fil des couteaux / Non danneggia il filo dei coltelli / Não danifica as facas
Resistencia a altas temperaturas / Heat resistant / Résistante aux hautes températures / Resistente alle alte temperature / Resistência a altas temperaturas
Material Ecológico / ECO select / Matériau écologique / Materiale Ecologico / Material ecológico.

	Caja Fibra de Celulosa y Resina	Box Resin and Cellulose Fibre	Boîte Fibre de Cellulose et Résine	Scatola Fibra di Cellulosa e Resina	Caixa Fibra de Celulose e Resina
--	------------------------------------	----------------------------------	---------------------------------------	--	-------------------------------------



766100

330x230mm / 13x9"

6,5mm / 0,2"

Tabla Salsera Mármol
 Serving Board Marble
 Planche à Découper Marbre
 Servire Marmol
 Tábua de Corte Mármore



692110

330x230mm / 13x9"

6,5mm / 0,2"

Tabla de corte Negra
 Cutting Board Black
 Planche à Découper Noire
 Tagliere Nero
 Tábua de Corte Preta



709100

330x230mm / 13x9"

6,5mm / 0,2"

Tabla de corte Natural
 Cutting Board Natural
 Planche à Découper Naturel
 Tagliere Naturale
 Tábua de Corte Natural



766200

377x227mm / 15x11"

6,5mm / 0,2"

Tabla Salsera Mármol
 Serving Board Marble
 Planche à Découper Marbre
 Servire Marmol
 Tábua de Corte Mármore



692210

377x227mm / 15x11"

6,5mm / 0,2"

Tabla Salsera Negra
 Serving Board Black
 Planche à Découper Noire
 Tagliere Servire Nero
 Tábua de Corte Preta



709200

377x227mm / 15x11"

6,5mm / 0,2"

Tabla Salsera Natural
 Serving Board Natural
 Planche à Découper Naturel
 Tagliere Servire Naturale
 Tábua de Corte Natural



766300

427x327mm / 17x13"

6,5mm / 0,2"

Tabla Salsera Mármol
 Serving Board Marble
 Planche à Découper Marbre
 Tagliere Servire Marmol
 Tábua de Corte Mármore



692310

427x327mm / 17x13"

6,5mm / 0,2"

Tabla Salsera Negra
 Serving Board Black
 Planche à Découper Noire
 Tagliere Servire Nero
 Tábua de Corte Preta



709300

427x327mm / 17x13"

6,5mm / 0,2"

Tabla Salsera Natural
 Serving Board Natural
 Planche à Découper Naturel
 Tagliere Servire Naturale
 Tábua de Corte Natural



709600

330x230mm / 13x9"

6,5mm / 0,2"

Tabla Salsera Natural
 Serving Board Natural
 Planche à Découper Naturel
 Tagliere Servire Naturale
 Tábua de Corte Natural



Este producto procede de bosques gestionados de forma sostenible y fuentes controladas / This product is from sustainably managed forests and controlled sources / Ce produit provient de forêts gérées de manière durable et de sources contrôlées / Questo prodotto proviene da foreste gestite in modo sostenibile e da fonti controllate / Este produto provém de florestas geridas de forma sustentável e de fontes controladas.



BOLSAS

KNIVES ROLL BAG
 TROUSSE COUTEAUX
 BORSA PORTACOLTELLI
 BOLSAS PARA FACAS

Para desplazamientos culinarios, las bolsas para cuchillos son el compañero de viaje ideal, ofreciendo comodidad y organización para llevar cuchillos y utensilios esenciales de cocina.

For culinary travels, knife bags are the ideal travel companion, offering comfort and organization to carry knives and essential kitchen utensils.

Pour vos déplacements les déplacements culinaires, les sacs à couteaux sont le compagnon de voyage idéal, offrant confort et organisation pour transporter couteaux et ustensiles de cuisine préférés.

Per i viaggi culinari, le borse per coltelli sono il compagno di viaggio ideale, offrendo comfort e organizzazione per trasportare coltelli e utensili da cucina essenziali.

Para deslocamentos culinários, as bolsas para facas são a companhia de viagem ideal, oferecendo conforto e organização para levar facas e utensílios de cozinha essenciais.

Organización Sencilla



Simple Organization · Organisation Facile · Organizzazione Semplice
 Organização Simples.

Diversas Capacidades de Almacenamiento

Various Storage Capacities · Diverses Capacités de Stockage · Diverse
 Capacità di Stoccaggio · Diversas Sapacidades de Armazenamento.

Protección en Transporte

Protection in Transport · Protection lors du Transport
 Protezione nel Trasporto · Proteção no Transporte.

	Caja	Box	Boîte	Scatola	Caixa
	100% Poliéster	100% Polyester	100% Polyester	100% Poliestere	100% Poliéster



690200

 460x275mm / 18x11"

Bolsa Cuchillos // Knife Roll Bag
Trousse Couteaux // Borsa
Portacoltelli // Saco Facas

4 Piezas // 4 Pieces // 4 Places
4 Pezzi // 4 peças



690400

 500x510mm / 19,6x20"

Bolsa Cuchillos // Knife Roll Bag
Trousse Couteaux // Borsa
Portacoltelli // Saco Facas

8 Piezas // 8 Pieces // 8 Places
8 Pezzi // 8 peças



690500

 730x510mm / 28,7x20"

Bolsa Cuchillos // Knife Roll Bag
Trousse Couteaux // Borsa
Portacoltelli // Saco Facas

12 Piezas // 12 Pieces // 12 Places
12 Pezzi // 12 peças



691400

 520x920mm / 20,4x36"

Bolsa Cuchillos // Knife Roll Bag
Trousse Couteaux // Borsa
Portacoltelli // Saco Facas

17 Piezas // 17 Pieces // 17 Places
17 Pezzi // 17 peças

	Bolsa	Bag	Sac	Borsa	Saço
	Poliéster 600D con Recubrimiento PVC	Polyester 600D Covering with PVC	Polyester 600D avec Recouvrement PVC	Poliestere 600D Ricoperto in PVC	Poliéster 600D Revestido de PVC

No incluye cuchillos // Knives not included
 Couteaux non fournis // Coltelli non compresi
 Não inclui facas.



694900

330 x 480 x 185mm
 12,9 x 18,8 x 7,2"

≈ 29L - 1,3Kg

Mochila Porta Cuchillos // Knife Backpack // Sac à dos Porte-couteaux // Zainetto Porta Coltelli Saco Facas

**9 Piezas // 9 Pieces // 9 Places
 9 Pezzi // 9peças**

	Caja	Box	Boîte	Scatola	Caixa
	Bolsa de Piel y Herrajes Metálicos	Leather Bag with Metallic Ironworks	Sac en Cuir et Ferronneries Métalliques	Borsa in Pelle e Accessori Metallo	Bolsa de Couro e Ferragens Metálicas



694800

863x446mm / 34x17,5"

Bolsa Piel Cuchillos // Leather Knife Roll Bag // Trousse couteaux cuir // Borsa in pelle // Estojo de pele

**10 Piezas // 10 Pieces // 10 Places
 10 Pezzi // 10 peças**



695100

470x446mm
 8,5x17,5"

Bolsa Piel Cuchillos // Leather Knife Roll Bag // Trousse couteaux cuir // Borsa in pelle // Estojo de pele

**5 Piezas // 5 Pieces // 5 Places
 5 Pezzi // 5 peças**



SOPORTES

KNIFE HOLDER
BLOCS COUTEAUX
PORTA COLTELLI
SUPORTE FACAS

Tacos que preservan el filo de los cuchillos y realzan la cocina con su diseño innovador, garantizando accesibilidad y estilo en cada uso.

Knife blocks that preserve the edge of the knives and enhance the kitchen with their innovative design, ensuring accessibility and style with every use.

Blocs de couteaux qui préservent le tranchant des couteaux et rehaussent la cuisine avec leur design innovant, garantissant accessibilité et style à chaque utilisation.

Blocchi per coltelli che preservano la lama dei coltelli e valorizzano la cucina con il loro design innovativo, garantendo accessibilità e stile in ogni utilizzo.

Blocos que preservam o fio das facas e realçam a cozinha com seu design inovador, garantindo acessibilidade e estilo a cada uso.

Protege el Filo de los Cuchillos

Protects the Knife Edge · Protège le Fil des Couteaux · Protegge il Filo dei Coltelli · Protege o Fio das Facas.

Variedad de Diseños



Various Designs · Designs Variés · Disegni Vari · Design Variados.

Funcionalidad

Functionality · Fonctionnel · Funzionalità · Funcionalidade.

Completa tu Cocina

Complete Your Kitchen · Complétez Votre Cuisine · Completa la Tua Cucina · Complete sua Cozinha.



	Caja Regalo	Gift Box	Boîte Cadeau	Scatola Regalo	Caixa de Presente
	Bambú	Bamboo	Bambou	Bambú	Bambu



793800

 280 x 215 x 90mm
11 x 8 x 3"

Soporte Cuchillos // Knife Holder
Bloc Couteaux // Porta Coltelli
Suporte Facas

	Caja Regalo	Gift Box	Boîte Cadeau	Scatola Regalo	Caixa de Presente
	Caucho Termoplástico + Fibras de Polipropileno (PP)	Thermoplastic Rubber + Polipropylene (PP) Fibre	Caoutchouc Thermoplastique + Fibre Polypropylène (PP)	Caucciù Termoplastico + Fibre di Polipropilene (PP)	Borracha Termoplástica + Fibra Polipropileno (PP)



794400

 225mm / 8,8"

 110mm / 4,3"

Soporte Cuchillos Redondo
Round Knife Holder // Bloc couteaux
Rond // Porta Coltelli Rotondo
Suporte Facas Redondo



794000

 225mm / 8,8"

 110mm / 4,3"

Soporte Cuchillos Redondo
Round Knife Holder // Bloc Couteaux
Rond // Porta Coltelli Rotondo
Cepo Universal Redondo // Suporte
Facas

 	Caja Regalo	Gift Box	Boîte Cadeau	Scatola Regalo	Caixa de Presente
	Caucho Termoplástico + Fibras de Polipropileno (PP)	Thermoplastic Rubber + Polipropylene (PP) Fibre	Caoutchouc Thermoplastique + Fibre Polypropylène (PP)	Caucciù Termoplastico + Fibre di Polipropilene (PP)	Borracha Termoplástica + Fibra Polipropileno (PP)



794100

 220 x 160 x 65mm
8,6 x 6,2 x 2,5"



Soporte Cuchillos Ovalado
Oval Knife Holder // Bloc couteaux
Oval // Porta Coltelli Ovale
Suporte Facas Ovalado



794500

 220 x 160 x 65mm
8,6 x 6,2 x 2,5"

Soporte Cuchillos Ovalado
Oval Knife Holder // Bloc Couteaux
Oval // Porta Coltelli Ovale
Suporte Facas Ovalado

 	Caja Regalo	Gift Box	Boîte Cadeau	Scatola Regalo	Caixa
	Bambú	Bamboo	Bambou	Bambú	Bambu

794300

 432 x 139 x 39mm
1,5 x 17 x 5,4"

Soporte Interior Cajón // Knife Holder Drawer // Bloc Universel
Tiroir // Porta Coltelli Per Casetto
Suporte de Bambu Para Gaveta





	Caja Regalo	Gift Box	Boîte Cadeau	Scatola Regalo	Caixa de Presente
	Madera de Caucho Fibras de Polipropileno	Rubberwood Polypropylene Fibers	Bois de Caoutchouc Fibres de Polypropylène	Legno di Gomma Fibre di Polipropilene	Madeira de Borracha Fibras de Polipropileno



794700

 225 x 185 x 150mm
8,8 x 7,2 x 2,3mm

Soporte Cuchillos // Knife Holder
Bloc Couteaux // Porta Coltelli
Suporte Facas



	Caja Regalo	Gift Box	Boîte Cadeau	Scatola Regalo	Caixa de Presente
	Bambú	Bamboo	Bambou	Bambú	Bambu



794800

 150 x 160 x 160mm
5,9 x 6,2 x 6,2"

Soporte Utensilios Bambú //
Bamboo Utensil Holder // Porte-
Utensiles Bambou // Portautensili
Bambu // Suporte Utensilios
Bambu

	Caja Regalo	Gift Box	Boîte Cadeau	Scatola Regalo	Caixa de Presente
	Acero Inoxidable + Fibras de Polipropileno (PP)	Stainless Steel + Polypropylene (PP) Fibre	Acier Inoxydable + Fibre Polypropylène (PP)	Acciaio Inossidabile + Fibre di Polipropilene (PP)	Aço Inoxidável + Fibras Polipropileno (PP)



794900

 220mm / 8,6"

 110mm / 4,3"

Soporte Cuchillos Redondo
Round Knife Holder // Bloc
Couteaux Rond // Porta Coltelli
Rotondo // Cepo Universal
Redondo // Suporte Facas

	<p>Caja Regalo</p> <p>Piedra Caliza en color Crema Madera de Roble</p>	<p>Gift Box</p> <p>Cream-Colored Limestone Oak Wood</p>	<p>Boîte Cadeau</p> <p>Pierre Calcaire Crème Bois de Chêne</p>	<p>Scatola Regalo</p> <p>Pietra Calcareia di Colore Crema Legno di Rovere</p>	<p>Caixa de Presente</p> <p>Calcário de Cor Creme Madeira de Carvalho</p>
--	--	---	--	---	---



795500

 280 x 364 x 78mm
11 x 14,3 x 3"

Soporte para Cuchillos de Piedra y Madera // Stone and Wooden Knife Holder // Bloc Couteaux en Pierre et en Bois // Supporto per Coltelli in Pietra e Legno // Suporte para Facas de Pedra e Madeira





SOPORTES MAGNÉTICOS

MAGNETIC RACK
BARRE AIMANTÉE
MAGNET
SUPORTES MAGNÉTICOS

Un lugar muy fiable dónde dejar tus cuchillos son nuestros soportes magnéticos. Tiene un potente imán que sujeta fuertemente las piezas y te permite tenerlas siempre cerca cuidando el estado de tus cuchillos.

Our magnetic knife holders are a very reliable place to leave your knives. They have a strong magnet that securely holds the pieces and allows you to have them always close by, taking care of your knives' condition.

Nos supports magnétiques pour couteaux sont un emplacement sûr pour ranger vos couteaux. Ils ont un aimant puissant qui maintient fermement les pièces en place et vous permet de les avoir toujours à portée de main, en préservant la qualité de vos couteaux.

I nostri supporti magnetici per coltelli sono un luogo molto affidabile dove lasciare i tuoi coltelli. Hanno un magnete potente che tiene saldamente i pezzi e ti permette di averli sempre a portata di mano, curando la condizione dei tuoi coltelli.

Nossos suportes magnéticos para facas são um lugar muito confiável para deixar suas facas. Eles têm um ímã potente que segura firmemente as peças e permite que você as tenha sempre por perto, cuidando da condição de suas facas.

Organización Sencilla

Simple Organization · Organisation Facile · Organizzazione Semplice
Organização Simples.

Previene el Deterioro Prematuro del Cuchillo

Prevents Premature Knife Deterioration · Préviene la Détérioration Prématuurée du Couteau · Previene il Deterioramento Precoce del Coltello · Previne a Deterioração Precoce da Faca.

Potente Imán

Powerful Magnet · Aimant Puissant · Magnete Potente Iman Potente.

Variedad de Diseños

Variety of Designs · Variété de Designs · Varie Design · Variedade de Designs.

	Estuche	Case	Étui	Astuccio	¡ Estojos
	PVC / Acero / ABS	PVC / Steel / ABS	PVC / Acier / ABS	PVC / Acciaio / ABS	PVC / Aço / ABS



692500

300x45mm / 11,8x1,7"

Soporte Magnético // Magnetic Rack // Barre Aimantée // Magnet Suporte Magnético



692600

450x45mm / 17,7x1,7"

Soporte Magnético // Magnetic Rack // Barre Aimantée // Magnet Suporte Magnético

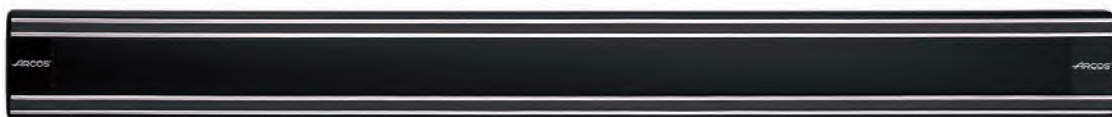

692700

500x45mm / 19,6x1,7"

Soporte Magnético // Magnetic Rack // Barre Aimantée // Magnet Suporte Magnético

	Estuche	Case	Étui	Astuccio	Estojos
	Bambú	Bamboo	Bambou	Bambú	Bambu



692800

300x45mm / 11,8x1,7"

Soporte Magnético // Magnetic Rack // Barre Aimantée // Magnet Suporte Magnético



692900

450x45mm / 17,7x1,7"

Soporte Magnético // Magnetic Rack // Barre Aimantée // Magnet Suporte Magnético

	Estuche	Case	Étui	Astuccio	Estojos
	Madera de Haya	Beechwood	Bois de Hêtre	Legno di Faggio	Madeira de Faia



695000

400x50mm / 15,7x2"

Soporte Magnético // Magnetic Rack // Barre Aimantée // Magnet Suporte Magnético



SACA-CORCHOS

CORKSCREW
TIRE BOUCHON PROF.
CAVATAPPI
SACA-ROLHAS

Explora nuestra selección de sacacorchos, desde modelos manuales clásicos hasta opciones eléctricas innovadoras, diseños que combinarán con cualquier estilo de cocina.

Explore our selection of corkscrews, from classic manual models to innovative electric options, designs that will match any kitchen style.

Explorez notre sélection de tire-bouchons, des modèles manuels classiques aux options électriques innovantes, des designs qui s'adapteront à tout style de cuisine.

Esplora la nostra selezione di cavitappi, dai modelli manuali classici alle opzioni elettriche innovative, design che si abbineranno a qualsiasi stile di cucina.

Explore nossa seleção de saca-rolhas, desde modelos manuais clássicos a opções elétricas inovadoras, designs que combinarão com qualquer estilo de cozinha.

Variedad de Diseños

Variety of Designs · Variété de Designs · Varie Design · Variedade de Designs.

Uso Rápido e Intuitivo



Quick and Intuitive use · Utilisation Rapide et Intuitive · Uso Rapido e Intuitivo
Uso Rápido e Intuitivo.

Mantenimiento Simple

Simple Maintenance · Entretien Facile · Manutenzione Semplice
Manutenção Simples.

Materiales Resistentes

Resistant Materials · Matériaux Résistants · Materiali Resistenti
Materiais Resistentes.



	Caja Regalo	Gift Box	Boîte Cadeau	Scatola Regalo	Caixa de Presente
	ABS Acero Inoxidable	ABS Stainless Steel	ABS Acier Inoxydable	ABS Acciaio Inossidabile	Madeira de Borracha Aço Inoxidável



607600

Sacacorchos Eléctrico // Electric
Corkscrew // Tire Bouchon Électrique
Cavatappi Elettrico // Saca-Rolhas
Elétrico

Incluye Cortacápsulas / Includes Foil Cutter / Coupe capsule inclus / Comprende Taglia-Capsulei / Inclui corta-cápsulas.

	Caja Regalo	Gift Box	Boîte Cadeau	Scatola Regalo	Caixa de Presente
	604600 ABS 604900 Acero Inoxidable - ABS	604600 ABS 604900 Stainless Steel- ABS	604600 ABS 604900 Acier Inoxydable - ABS	604600 ABS 604900 Acciaio Inossidabile - ABS	604600 ABS 604900 Aço Inoxidável - ABS



604600

Sacacorchos Elec. // Elec. Corkscrew
Tire Bouchon Prof. Elec. // Cavatappi
Elec. // Saca-Rolhas Elétrico



604900

Sacacorchos Eléctrico // Electric
Corkscrew // Tire Bouchon Électrique
Cavatappi Elettrico // Saca-Rolhas
Elétrico

Incluye Cargador / Charger Included / Chargeur Fourni / Caricatore Incluso / Inclui carregador

Incluye Cortacápsulas / Includes Foil Cutter / Coupe capsule inclus / Comprende Taglia-Capsulei / Inclui corta-cápsulas.

	Caja Regalo	Gift Box	Boite Cadeau	Scatola Regalo	Caixa de Presente
	ABS Aleación de Zinc	ABS Zinc Alloy	ABS Alliage de Zinc	ABS Lega di Zinco	ABS Liga de Zinco



604100

Sacacorchos // Corkscrew
Tire Bouchon Prof // Cavatappi
Saca-Rolhas

Incluye Cortacápsulas / Includes Foil Cutter / Coupe capsule inclus / Comprende Taglia-Capsulei / Inclui corta-cápsulas



607500

Sacacorchos // Corkscrew
Tire Bouchon Prof // Cavatappi
Saca-Rolhas

 	Caja Regalo	Gift Box	Boîte Cadeau	Scatola Regalo	Caixa de Presente
	ABS Aleación de Zinc + Elastómero	ABS Zinc Alloy + Elastomer	ABS Alliage de Zinc + Élastomère	ABS Lega di Zinco + Elastomero	Madeira de Borracha Liga de Zinco + Elastómero



604700

Sacacorchos // Corkscrew
Tire Bouchon Prof // Cavatappi
Saca-Rolhas

Incluye Cortacápsulas / Includes Foil Cutter / Coupe capsule inclus / Comprende Taglia-Capsulei / Inclui corta-cápsulas.

 	Caja Regalo	Gift Box	Boîte Cadeau	Scatola Regalo	Caixa de Presente
	Aleación Zinc	Zinc Alloy	Alliage de Zinc	Legno di Zinco	Liga de Zinco



603400

195mm / 7,6"

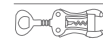

Sacacorchos // Corkscrew
Tire Bouchon Prof // Cavatappi
Saca-Rolhas



SOPORTES JAMÓN

HAM HOLDER SUPPORT
SUPPORT À JAMBON
SUPPORTO PROSCIUTTO FRAGGIO
SUPORTE PRESUNTO

Nuestros soportes jamoneros aportan seguridad y versatilidad a tu cocina, ajustándose a cualquier tamaño de jamón o paletilla, y destaca su limpieza sin complicaciones.

Our ham holders provide safety and versatility to your kitchen, adjusting to any size of ham or shoulder, and are notable for their hassle-free cleaning.

Nos supports à jambon offrent sécurité et polyvalence à votre cuisine, s'ajustant à toutes tailles de jambon ou d'épaule et se distinguent par leur facilité d'entretien.

I nostri supporti per prosciutto forniscono sicurezza e versatilità alla tua cucina, adattandosi a qualsiasi dimensione di prosciutto o spalla, e si distinguono per la loro pulizia senza problemi.

Nossos suportes para presunto proporcionam segurança e versatilidade à sua cozinha, ajustando-se a qualquer tamanho de presunto ou paleta, e são notáveis pela sua limpeza descomplicada.

Gran Sujeción y Estabilidad

Great grip and Stability · Grande Prise et Stabilité · Grande Presa e stabilità
Grande Aderência e Estabilidade.

Seguro y fácil de usar

Safe and Easy to Use · Sûr et Facile à Utiliser · Sicuro e Facile da Usare
Seguro e Fácil de Usar.

Diseño Ergonómico

Ergonomic Design · Design Ergonomique · Design Ergonomico
Design Ergonómico.

Materiales resistentes

Resistant Materials · Matériaux résistants · Materiali Resistenti
Materiais Resistentes.

Variedad de Diseños

Variety of Designs · Variété de Designs · Varie Design · Variedade
de Designs.

	Caja Regalo	Gift Box	Boîte Cadeau	Scatola Regalo	Caixa de Oferta
	Madera de Pino Lacada en Color Caoba Herrajes Metálicos	Mahogany Coloured Pine Lacquered Metallic Ironworks	Bois de Pin Laqué Couleur Acajou Ferrerries Métalliques	Legno di Pino Laccato di color Mogano Accessori Metallo	Madeira de Pinho Laqueada na Cor Mogno Ferragens Metálicas



683200

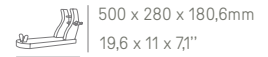

Soporte Jamón Pino Lacado
Ham Holder Laquered Pine
Support à Jambon Pin Laqué
Supporto Prosciutto PinoLaccato
Suporte Presunto Pinho Lacado



	Caja Regalo	Gift Box	Boîte Cadeau	Scatola Regalo	Caixa de Oferta
	Madera de Pino Lacada en Color Natural Herrajes Metálicos	Natural Colour Lacquered Pine Wood Metallic Ironworks	Bois de pin laqué Couleur Naturel Ferrerries Métalliques	Legno di Pino Laccato di color Naturali Accessori Metallo	Madeira de Pinho Laqueada em Cor Natural Ferragens Metálicas

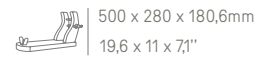

683300



Soporte Jamón Pino Lacado
Ham Holder Laquered Pine
Support à Jambon Pin Laqué
Supporto Prosciutto PinoLaccato
Suporte Presunto Pinho Lacado

	Caja Regalo	Gift Box	Boîte Cadeau	Scatola Regalo	Caixa de Presente
	Polietileno PE-500 Acero Inoxidable AISI-304	Polyethylene PE-500 AISI-304 Stainless Steel	Polyéthylène PE-500 Acier Inoxydable AISI-304	Polietilene PE-500 Acciaio Inossidabile AISI-304	Polietileno PE-500 Aço Inoxidável AISI-304



693900

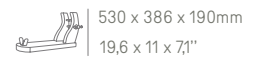

Soporte Jamón
Ham Holder
Support à Jambon
Supporto Prosciutto
Suporte Presunto

EXPOSITORES



POINT OF SALE DISPLAYS
PRESENTOIRS
EXPOSITORI
EXPOSITORES





54221

17 x 37,5cm

Expositor Tablas (Polimetacrilato de Metilo Acrílico) // Cutting Board Display (Polymethyl Methacrylate PMMA) // Prés. Planches à découper (PMMA Polyméthacrylate de Méthyle Acrylique) // Espositore Taglieri (PMMA Polimetacrilato) // Expositor de tábuas (Polimetilmetacrilato PMMA)



54230

60 x 30 x 20cm

Expositor Mostrador Mondadores (Madera y Metal) Paring Knives Counter Display (Wood and Metal) Présentoir Couteaux Office (Bois et Métal) Espositore Coltelli Multiuso (Legno e Metallo) Expositor Balcão Descascadores (Madeira e Metal)



54229

59 x 33 x 20cm

Exp. Mostrador Mondadores (Madera y Metacrilato) Paring Knives Counter Display (Wood and Methacrylate) Prés. Couteau Office (Bois et Métacrylate) Espositore Coltelli Multiuso (Legno e Metacrilato) Expositor Balcão Descascadores (Madeira e Metacrilato)



54258

36 x 36,5 x 15cm

Exp. Mostrador (Madera y Metacrilato) Display Counter (Wood and Acrylic) Comptoir Expositant (Bois et Acrylique) Espositore Banco (Legno e Metacrilato) Expositor Balcão (Madeira e Acrílico)



54233

38 x 37 x 13cm

Exp. Mostrador Chuleteros (Madera e Imán) Steak Knives Counter Display (Wood and Magnet) Prés. Couteaux Steak (Bois et Aimant) Espositore Coltelli Bistecca (Legno e Magnete) Expositor Balcão para Costoletas (Madeira e Imã)



54263

170 x 65 x 34cm

Expositor Cuberterias (Madera y Metacrilato) Cutlery Display (Wood and Acrylic) Présentoir couverts (Bois et Acrylique) Espositore posate (Legno e Metacrilato) Expositor de Talheres (Madeira e Acrílico)



54236

170 x 55 x 38cm

Expositor Suelo (Metal y Madera)
 Display (Metal and Wood)
 Présentoir sol (Métal et Bois)
 Esp. Da Terra (Metallo e Legno)
 Exp. Solo (Metálico e Madeira)



54259

190 x 90 x 37,5cm

Exp. Cazuelas, Sartenes y Cuchillos (Madera)
 (Wooden) Cookware and Knives Display
 Prés. Casseroles, poêles et couteaux (Bois)
 Esp. Padelle, Pentole E Coltelli (Legno)
 Expositor Tachos, Frigideiras E Facas (Madeira)



54260

190 x 55 x 37,5cm

Expositor Cuchillos (Madera)
 Knives Display (Wood)
 Présentoir Couteaux (Bois)
 Espositore Coltelli (Legno)
 Expositor de Tachos (Madeira)



54262

140 x 70 x 160cm

Expositor Dos Lados (Madera)
 Two-Sides Display (Wood)
 Présentoir Deux Côtés (Bois)
 Espositore a Due Lati (Legno)
 Expositor de Duplo Lado (Madeira)



54217

138 x 60 x 20cm

Expositor Pared (Madera y Cristal)
 Wall Display (Wood and Crystal)
 Présentoir mural (Bois et Cristal)
 Espositore da parete (Legno e Cristallo)
 Expositor de Parede (Madeira e Cristal)



54232

80 x 13cm

Expositor Tira Colgador (Polipropileno)
 Hanging Display (Polypropylene)
 Prés. Bande à suspendre (Polypropylène)
 Espositore Cravatta (Polipropilene)
 Expositor Tira Peneira (Polipropileno)

ARCOS®

BROOKLYN



Made in Spain

Since 1734

Cocinero

210 mm





REF :	PÁG:	REF :	PÁG:	REF :	PÁG:	REF :	PÁG:	REF :	PÁG:
100100 91	152600 80	185701 236	188625 94	NEW 202000 148
100101 91	160100 45	185721 236	188628 94	NEW 202100 148
100400 91	160400 45	185722 236	188631 94	NEW 202200 148
100401 91	160600 45	185723 236	188632 94	NEW 202300 148
100500 91	160800 45	185725 236	188633 94	NEW 202400 149
100501 91	161100 45	185900 239	188634 94	NEW 202500 149
100600 92	161300 46	185901 239	188676 94	NEW 202600 149
100601 92	161400 46	185924 239	188677 94	210100 75
100700 92	161600 46	186000 237	188678 94	210400 75
100701 92	161900 46	187000 99	188700 95	210600 75
100800 92	162000 45	NEW 187100 100	188800 95	210700 75
100801 92	162300 46	NEW 187200 100	188821 95	211100 75
101300 92	162600 46	188000 95	188822 95	211900 75
101301 92	163200 47	188100 95	188823 95	212000 76
101500 92	163300 47	188200 95	188824 95	212100 76
101501 92	164900 57	188300 94	188825 95	NEW 213000 35
102500 91	165000 57	188301 94	188900 96	NEW 213200 35
102501 91	165100 57	188400 94	189000 97	NEW 213400 35
102700 91	165300 57	188401 94	189100 97	NEW 213500 35
102701 91	165400 58	188421 94	189421 97	NEW 213700 35
134900 85	165500 57	188422 94	189422 97	223300 52
135000 83	165900 58	188500 94	189500 98	224900 51
135200 83	166100 57	188501 94	189621 98	225000 52
135300 83	166400 58	188510 94	189622 98	225100 53
135400 83	166600 59	188521 94	189700 98	225200 53
135500 84	166700 58	188522 94	189800 99	225300 53
135600 84	166800 58	188523 94	189900 99	225600 51
135700 84	167000 60	188524 94	190123 39	225700 51
135800 83	167100 60	188525 94	190423 39	225800 52
136100 85	167200 59	188528 94	190623 39	225900 52
136500 85	167400 60	188576 94	190823 39	226000 52
136700 84	168000 59	188577 94	191123 39	226200 52
150200 78	168100 59	188578 94	191323 40	226400 51
150300 78	168200 59	188600 94	191623 40	226500 52
150500 78	181300 281	188601 94	191923 40	226600 51
150700 78	185300 239	188610 94	192023 40	226700 53
150800 78	185301 239	188611 94	192623 40	226800 53
150900 78	185324 239	188612 94	194000 41	226900 51
151000 79	185400 237	188613 94	NEW 201000 146	227000 54
151400 79	185500 237	188614 94	NEW 201100 146	228700 54
151500 79	185601 234	188615 94	NEW 201200 146	229900 51
151600 79	185610 235	188618 94	NEW 201300 146	230200 63
151800 79	185621 234	188621 94	NEW 201400 147	230224 69
151900 80	185622 235	188622 94	NEW 201500 147	230500 63
152000 81	185623 235	188623 94	NEW 201600 147	230524 69
152100 81	185625 235	188624 94	NEW 201700 147	230600 63

REF :	PÁG:	REF :	PÁG:	REF :	PÁG:	REF :	PÁG:	REF :	PÁG:
230200 63	240700 123	280004 102	285500 116	290423 129
230224 69	240800 123	280104102	285600 117	290425 129
230500 63	241000 121	280204 105	285700 118	290431 129
230524 69	241100 121	280304 105	285800 116	290500 129
230600 63	241200 121	280404 105	286004 108	290521 129
230624 69	241300 121	280504 105	286104 111	290522 129
231000 65	241400 122	280601 105	286204 111	290523 129
231024 71	241500 122	280604 105	286304 111	290525 129
231100 65	241600 122	280704 106	286400 111	290600 134
231124 71	241700 122	280804 106	286500 111	290621 134
231300 65	242000 124	281004 102	286600 110	290622 134
231324 71	242100 124	281104 102	286700 112	290623 134
231500 65	242200 124	281204 103	286800 112	290625 134
231524 71	242300 124	281304 103	287000 113	290700 130
232000 63	242500 124	281404 103	287100 113	290721 130
232024 71	242600 125	281504 103	287200 113	290722 130
232800 63	242700 125	281604 104	287300 114	290723 130
232824 69	242800 125	281704 104	287800 113	290724 130
232900 65	242900 125	281801 107	287900 113	290725 130
233000 65	243000 122	281804 107	287400 114	290728 130
233100 64	243100 121	281901 107	288200 110	290800 130
233124 70	243200 121	281904 107	288300 110	290821 130
233200 64	243500 125	282004 107	288400 109	290822 130
233224 70	244100 122	282104 106	288804 108	290823 130
233300 63	245400 124	282204 106	289004 102	290824 130
233324 69	277100 270	282404 110	289104 103	290825 130
233400 64	277200 274	282504 102	289704 108	290828 130
233424 70	278100 293	282604 102	289804 108	290900 130
233500 64	278138 293	282704 102	289904 108	290921 130
233524 70	278200 293	282904 112	290000 129	290922 130
233600 64	278400 293	283004 112	290021 129	290923 130
233624 70	278510 294	283104 112	290022 129	290925 130
233700 64	278511 294	283204 112	290023 129	291100 138
233724 70	278512 294	283304 112	290025 129	291125 138
233800 64	278513 294	283704 109	290031 129	291200 135
234200 66	278514 294	283804 107	290100 129	291222 135
234300 66	278515 294	283904 106	290121 129	291223 135
234524 72	279010 294	284004 109	290122 129	291225 135
235024 72	279200 293	284100 104	290123 129	291300 135
240000 121	279202 293	284204 103	290125 129	291322 135
240100 123	279400 293	284304 106	290300 134	291323 135
240200 123	279600 294	284604 104	290325 134	291325 135
240300 123	279623 294	284704 104	290400 129	291400 137
240500 123	279900 294	284804 104	290421 129	291424 137
240600 123	279923 294	285000 117	290422 129	291425 137

REF :	PÁG:	REF :	PÁG:	REF :	PÁG:	REF :	PÁG:	REF :	PÁG:
291431 137	292300 130	293500 138	295100 134	297100 140
291500 132	292321 130	293525 138	295122 134	297123 140
291522 132	292322 130	293600 137	295123 134	297200 141
291523 132	292325 130	293624 137	295125 134	297222 141
291525 132	292400 133	293625 137	295200 134	297225 141
291600 132	292422 133	293700 137	295222 134	297500 141
291622 132	292423 133	293724 137	295223 134	297522 141
291623 132	292425 133	293725 137	295225 134	297525 141
291625 132	292500 133	293800 138	295300 136	297700 141
291700 132	292522 133	293825 138	295322 136	297722 141
291722 132	292523 133	294000 135	295323 136	298100 142
291723 132	292525 133	294022 135	295325 136	298122 142
291725 132	292600 136	294025 135	295400 136	298123 142
291800 132	292622 136	294100 135	295422 136	298223 142
291822 132	292623 136	294122 135	295423 136	298300 142
291823 132	292625 136	294125 135	295425 136	298322 142
291825 132	292700 136	294200 135	295500 134	299100 143
291900 132	292721 136	294225 135	295522 134	299125 143
291922 132	292722 136	294400 129	295525 134	298500 139
291923 132	292723 136	294422 129	295700 139	298800 139
291925 132	292725 136	294425 129	295725 139	298825 139
292000 130	292800 136	294500 135	295800 133	299500 143
292021 130	292822 136	294521 135	295822 133	299525 143
292022 130	292823 136	294522 135	295823 133	299600 143
292023 130	292825 136	294523 135	295825 133	299625 143
292025 130	292900 131	294524 135	295900 133	299700 143
292100 129	292922 131	294525 135	295922 133	299725 143
292110 129	292923 131	294600 131	295923 133	370000 186
292115 129	292925 131	294622 131	295925 133	370025 186
292121 129	293000 131	294623 131	296000 133	370100 184
292122 129	293022 131	294625 131	296022 133	370200 184
292123 129	293023 131	294700 131	296023 133	370500 186
292124 129	293025 131	294722 131	296025 133	370525 186
292125 129	293100 134	294723 131	296100 140	370600 186
292128 129	293123 134	294725 131	296122 140	370625 186
292131 129	293125 134	294800 131	296123 140	371400 190
292200 130	293200 137	294822 131	296125 140	371500 190
292210 130	293224 137	294823 131	296510 131	371501 190
292215 130	293225 137	294825 131	296515 131	371600 190
292221 130	293300 138	294900 138	296700 140	371601 190
292222 130	293322 138	294925 138	296722 140	371700 190
292223 130	293323 138	295000 137	296723 140	371800 166
292224 130	293400 138	295024 137	296725 140	371822 166
292225 130	293422 138	295025 137	297000 140	370025 186
292228 130	293425 138	295028 137	297023 140	370100 184

REF :	PÁG:	REF :	PÁG:	REF :	PÁG:	REF :	PÁG:	REF :	PÁG:
370200 184	375500 160	521000 240	574200 226	596800 204
370500 186	375800 160	539000 232	574300 225	596900 204
370525 186	375900 161	539100 232	574400 226	597000 204
370600 186	376500 160	541300 198	574500 225	597100 204
370625 186	376900 161	541500 198	574600 226	597200 204
371400 190	377000 192	541600 198	574700 225	597300 206
371500 190	377100 169	541700 198	574800 225	597400 206
371501 190	377400 163	542000 199	574900 225	597500 207
371600 190	377600 192	560100 217	575000 225	597600 202
371601 190	377700 191	560200 216	585000 212	603000 286
371700 190	377900 162	560300 217	585100 212	603400 314
371800 166	378000 163	560400 219	585200 210	603500 286
371822 166	378100 163	560500 217	585400 211	603600 286
371823 166	378200 163	560600 216	585600 210	603900 291
371900 166	378400 163	560700 217	585700 212	604100 313
372000 192	NEW 378800 191	560800 219	585800 211	604500 286
372100 166	379300 87	560900 216	585900 210	604600 312
372200 170	379301 87	560902 216	586000 212	604700 314
372300 169	379400 87	561000 217	586100 211	604900 312
372400 173	379500 87	561100 219	586200 210	605000 279
372500 167	460100 182	561200 216	586300 211	605100 278
372600 168	460400 182	561300 219	586400 210	606100 278
372700 167	479200 194	561600 218	586600 212	606200 278
373000 166	479400 194	561700 219	586700 211	606300 278
373200 190	479500 194	561800 218	586800 212	606400 279
373424 88	479600 194	561900 218	586900 213	606500 278
373624 88	480100 195	562000 218	587000 213	607000 280
NEW 373651 89	485300 152	562100 218	587200 214	607100 280
NEW 373652 89	485329 152	562400 220	587400 213	607200 280
NEW 373656 89	485700 152	562500 220	595000 203	607300 281
373700 156	485729 152	565600 161	595100 203	607420 281
373723 156	485900 152	570100 223	595200 202	607500 313
373728 156	485929 152	570200 222	595300 203	NEW 607600 312
373800 180	500600 243	570300 223	595400 205	610700 291
373900 157	501100 243	570400 224	595500 203	610000 290
373923 157	502200 242	570600 222	595600 202	610200 290
373928 157	502300 242	570700 223	595700 203	610600 290
374000 180	502400 242	570800 224	595800 205	612100 281
374200 167	504200 243	570900 222	595900 202	612200 275
374610 168	504300 243	570902 222	596000 203	612300 275
374700 173	506100 232	571000 223	596100 205	612700 275
374800 173	507010 230	571100 224	596200 202	612800 276
375000 174	507100 230	572100 223	596300 205	613000 275
375100 174	513500 240	572400 224	596600 204	613100 275
375200 173	516500 240	574100 226	596700 206	613200 276

REF :	PÁG:	REF :	PÁG:	REF :	PÁG:	REF :	PÁG:	REF :	PÁG:
613300 279	692800 310	NEW 717122 252	791600 271	54217 319
613400 279	692900 310	NEW 717124 250	791800 272	54221 318
613600 274	693900 316	717210 258	792300 115	54229 318
613700 277	694800 303	NEW 717222 251	792400 115	54230 318
613800 277	694900 303	NEW 717224 249	793100 285	54232 319
614200 276	695000 310	717310 258	793800 305	54233 318
614300 276	695100 303	717410 258	794000 305	54236 319
614400 276	697500 259	717510 258	794100 306	54258 318
614500 277	697900 267	717810 259	794300 306	54259 319
614600 277	701000 160	718000 263	794400 305	54260 319
614800 277	701800 162	718100 263	794500 306	54262 319
615000 297	701900 162	718200 263	794700 307	54263 318
615100 297	702000 160	718300 264	794800 307	2873000 114
615200 297	702100 161	718400 264	794900 307	2874000 115
615300 297	702300 163	718500 264	795000 270	2875000 115
615400 297	708000 299	718600 264	795100 270	2878000 115
616600 275	708100 299	718700 265	795500 308	2879000 114
616800 276	708200 299	718800 265	802900 184	7198000 267
617100 282	708300 299	718900 265	802910 184		
617200 282	709100 300	719000 265	803000 174		
683200 316	709200 300	719100 265	803800 168		
683300 316	709300 300	719200 265	804000 175		
685000 284	709600 300	719300 266	804100 175		
685100 285	716010 255	719400 266	805109 175		
685200 284	716110 255	719500 266	805900 53		
685300 284	716210 255	719600 266	806100 96		
685400 285	NEW 716122 251	719700 266	806200 96		
685500 284	NEW 716124 249	719800 263	807000 158		
685600 285	716310 255	740009 174	807100 158		
NEW 685700 284	NEW 716322 251	765000 299	807200 158		
689900 271	NEW 716324 249	765100 299	807410 116		
690200 302	716410 256	765200 299	809700 232		
690400 302	716510 256	765300 299	809800 232		
690500 302	NEW 716522 251	766100 300	830400 169		
691400 302	NEW 716524 249	766200 300	830600 176		
691510 299	716610 256	766300 300	830700 176		
691610 299	716710 256	780800 274	830800 176		
691710 299	716810 257	782100 294	834200 66		
691810 299	716910 257	784901 234	838310 66		
692110 300	NEW 716922 252	784911 234	838410 72		
692210 300	NEW 716924 250	790200 270	NEW 849000 89		
692310 300	717010 257	790500 271	849300 88		
692500 310	NEW 717022 252	790600 272	858100 47		
692600 310	NEW 717024 250	790800 272	858110 41		
692700 310	717110 257	790900 115	859800 96		

CALIDAD

QUALITÀ
QUALITY
QUALITÉ
QUALIDADE

✓ 10 YEAR GUARANTEE

Desde su nacimiento Arcos Hermanos ha trabajado por la mejora constante del nivel de calidad de sus productos. Un equipo humano con una formación excelente y una larga trayectoria profesional, se encarga de automatizar los procesos de trabajo para alcanzar el mejor rendimiento y control, y así lograr los máximos estándares de calidad. El Certificado ISO 9001:2015 lo corrobora y reconoce internacionalmente. Además, ARCOS dispone también de un Registro Sanitario (39.03065/AB), y la prestigiosa certificación norteamericana NSF (National Sanitary Foundation).
ARCOS HNOS. S.A. GARANTIZA SUS PRODUCTOS DURANTE DIEZ AÑOS, contra todo defecto de fabricación, siempre que se haga uso racional de la pieza para el cual está fabricada.

Since our birth as a company, Arcos Hermanos has always strived for the constant improvement of quality in all its products. Our highly specialized and well trained team of professionals constantly strives to improve our manufacturing processes and techniques in order to achieve the highest output and control with the highest quality standards. This is how Arcos achieves our goal of the highest quality standards of all our products. Our ISO 9001:2015 certification confirms and recognizes our international standards of quality control. Arcos also has a national Registry Health Number (39.03065/AB) and has gained the prestigious certification from the NSF (National Sanitary Foundation), an American organization which certifies our products as suitable and safe to be in contact with food. **ARCOS HNOS. S.A. WARRANTS ITS PRODUCTS against defects in material and workmanship under normal and proper use FOR A PERIOD OF TEN YEARS.**

Depuis sa naissance, Arcos Hermanos a constamment cherché à améliorer le niveau de qualité de ses produits. Son équipe humaine, d'excellente formation, acquise à travers leur expérience professionnelle, se charge de l'automatisation des procédés de travail afin d'obtenir le meilleur rendement et contrôle permettant par conséquent d'atteindre les maximums standards de qualité. Le Certificat ISO 9001:2015 reflète cette exigence de qualité reconnue mondialement. **ARCOS HNOS. S.A. GARANTIE QUE SES PRODUITS PENDANT DIX ANS, contre tout défaut de fabrication, dans un usage normal d'utilisation. De plus, ARCOS dispose d'un Registre Sanitaire (39.030065/AB), et de la prestigieuse certification nord-américaine NSF (National Sanitary Foundation).**

Fino dalla sua nascita, Arcos Hermanos ha lavorato con la finalità di migliorare costantemente il livello di qualità dei suoi prodotti. Un gruppo umano con una formazione eccellente e una grande professionalità è incaricato della automatizzazione dei processi di lavorazione al fine di ottenere il massimo rendimento e controllo produttivo, unitamente al perfezionamento continuo e costante della qualità. Il Certificato ISO 9001:2015 è a testimoniare questo riconoscimento internazionale.

Inoltre ARCOS si fregia del diploma emesso dal Registro Sanitario (39.03065/AB), unitamente alla prestigiosa esclusiva Certificazione U.S.A. NSF (National Sanitary Foundation). **ARCOS HNOS. S.A., in Avda Gregorio Arcos, s/n – ALBACETE-Spagna, GARANTISCE TUTTI I SUOI PRODOTTI PER 10 ANNI, contro tutti i difetti di fabbricazione, purchè si faccia uso corretto dell'utensile per il quale lo stesso è stato prodotto.**

Desde o seu nascimento, a Arcos Hermanos tem trabalhado para melhorar constantemente o nível de qualidade dos seus produtos. Uma equipa com excelente formação e uma longa carreira profissional, é responsável pela automatização dos processos de trabalho para alcançar o melhor desempenho e controlo, e assim alcançar os mais elevados padrões de qualidade. O certificado ISO 9001:2015 corrobora e reconhece isto internacionalmente. Além disso, a ARCOS também tem um Registo Sanitário (39.03065/AB), e a prestigiada certificação americana NSF (National Sanitary Foundation). **ARCOS HNOS. S.A. GARANTE OS SEUS PRODUTOS PARA DEZ ANOS, contra todos os defeitos de fabrico, desde que a peça para a qual é fabricada seja utilizada racionalmente.**

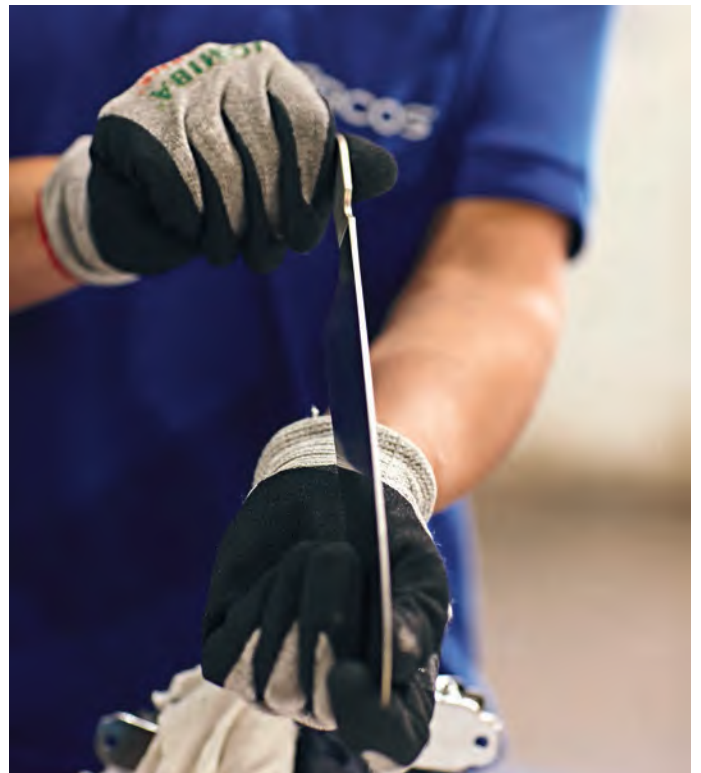

DISEÑO E INNOVACIÓN

DESIGN AND INNOVATION
DESSIN ET INNOVATION
DESIGN E INNOVAZIONE
DESIGN E INOVAÇÃO

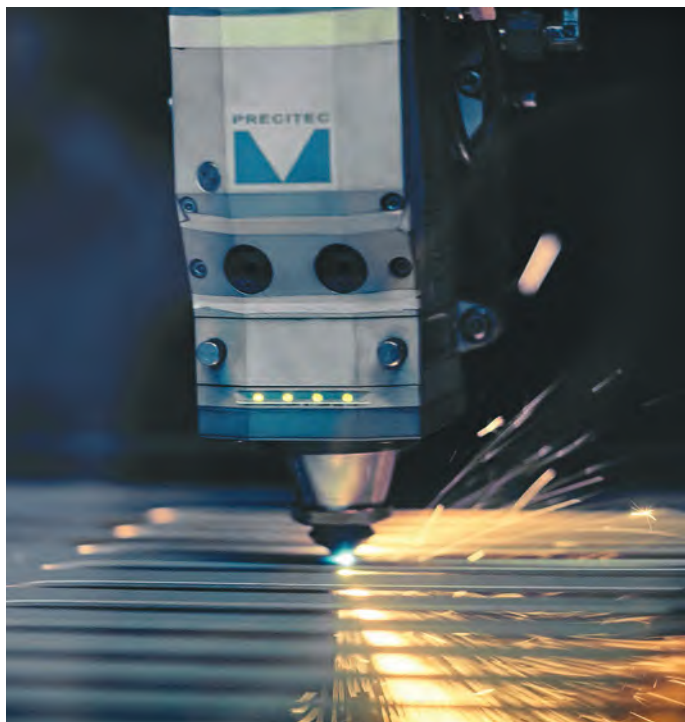

ARCOS HERMANOS es una empresa cuyo compromiso con el Diseño se ha visto reconocido a través de numerosos premios. Fuimos galardonados con el Premio Castilla-La Mancha de Diseño en el año 2007 y estuvimos nominados a los Premios Nacionales de Diseño, un galardón que se encuentra dentro de los más importantes dentro de nuestro país y que es otorgado por el Ministerio de Industria, Turismo y Comercio y la Fundación Barcelona Centre de Disseny. El diseño es para nosotros una pieza fundamental en nuestro trabajo. Al igual que la innovación, que juega un papel crucial dentro de nuestra compañía y se ha convertido en una herramienta estratégica indispensable a la hora de trabajar. Queremos ofrecer nuevas alternativas que mejoren la vida de nuestros clientes. Un ejemplo de ello es el acero exclusivo NITRUM®, una apuesta que nos ha convertido en pioneros en utilizar este tipo de material.

ARCOS HERMANOS is a company whose commitment to design has been recognised with numerous awards. The company was awarded the Castile-La Mancha Design Awards in 2007 and was nominated for the National Design Awards, an award which is among one of the most important in our country and which is awarded by the Ministry of Industry, Tourism and Commerce and the BCF (Barcelona Centre de Disseny) Foundation. The design is for us a cornerstone in our work. Just like innovation, it plays a crucial role within our company and has become an indispensable strategic tool when it comes to working. We want to offer new alternatives which will improve the lives of our customers. One such example is the exclusive steel NITRUM®, a commitment which has made ARCOS pioneers in using this type of material.

ARCOS HERMANOS est une société très primée pour son engagement dans le Design. Nous avons reçu le Prix Castille-La Manche du Design en 2007 et nous avons été nominés aux Prix Nationaux Design, l'un des principaux prix en Espagne, décerné par le Ministère de l'industrie, du Tourisme et du Commerce et par la Fondation Barcelona Centre de Disseny. Pour nous, le design est un élément essentiel dans notre travail. Il en est de même pour l'innovation, qui joue un rôle central dans notre société et qui est devenue un outil stratégique indispensable dans notre travail. Nous souhaitons proposer de nouvelles alternatives capables d'améliorer la vie de nos clients. L'acier exclusif NITRUM® en est un bon exemple, car c'est un pari qui a fait de nous des pionniers dans l'utilisation d'un matériau de cette nature. L'impegno posto dalla ditta ARCOS HERMANOS nel Design è stato riconosciuto con molti premi. Nel 2007 ricevemmo il Premio Castilla-La Mancha di Design e fummo nominati ai Premi Nazionali di Design, un premio fra i più importanti nel nostro Paese e concesso dal Ministero dell'Industria, del Turismo e del Commercio e dalla Fondazione Barcelona Centre de Disseny. Per noi il design è un elemento fondamentale del nostro lavoro. Come l'innovazione, che gioca un ruolo fondamentale nella nostra compagnia ed è diventata uno strumento strategico indispensabile per il lavoro. Vogliamo offrire nuove alternative che migliorino la vita dei nostri clienti. Un esempio è l'acciaio esclusivo NITRUM®, una scommessa che ci ha fatti diventare dei pionieri nell'utilizzo di questo tipo di materiale.

ARCOS HERMANOS is a company whose commitment to design has been recognised with numerous awards. The company was awarded the Castile-La Mancha Design Awards in 2007 and was nominated for the National Design Awards, an award which is among one of the most important in our country and which is awarded by the Ministry of Industry, Tourism and Commerce and the BCF (Barcelona Centre de Disseny) Foundation. The design is for us a cornerstone in our work. Just like innovation, it plays a crucial role within our company and has become an indispensable strategic tool when it comes to working. We want to offer new alternatives which will improve the lives of our customers. One such example is the exclusive steel NITRUM®, a commitment which has made ARCOS pioneers in using this type of material.

SERVICIO

SERVICE
PROCESSUS ET MATÉRIAUX
SERVIZIO
PROCESSOS E MATERIAIS



Una estrecha relación con el cliente es uno de los pilares de nuestra empresa. Mantener un buen trato con ellos y satisfacer sus necesidades es algo en lo que hacemos mucho hincapié y por ello dedicamos un gran esfuerzo en el tema de logística. Un buen sistema de producción mejora los tiempos de preparación y envío, por eso ponemos toda nuestra confianza en las mejores compañías de mensajería urgente. Esto nos asegura que nuestros productos llegan en las mejores condiciones y en los tiempos estimados.

A close relationship with the customer is one of the cornerstones of our company. Maintaining good customer service and meeting their needs is something in which we go to great lengths to lay considerable emphasis on and it is for this reason that we devote a great deal of effort as regards logistics. A good production system improves preparation and shipping times, that is why all our trust is placed in the best express courier companies. This ensures that our products arrive in the very best conditions and on-time as per scheduled delivery deadlines.

L'un des piliers essentiels de notre entreprise repose sur la proximité avec nos clients. Nous attachons une grande importance à entretenir des relations solides avec eux et à répondre à leurs besoins. C'est la raison pour laquelle nous investissons considérablement dans notre logistique. Un système de production efficace nous permet d'optimiser les délais de préparation et d'expédition. C'est pourquoi nous faisons entièrement confiance aux meilleures sociétés de transport. Nous veillons ainsi à ce que nos produits parviennent à destination dans les meilleures conditions et dans les délais impartis.

Uno stretto rapporto con il cliente è uno dei pilastri della nostra ditta. Insistiamo molto nel trattare bene i clienti e soddisfare le loro necessità e, per questa ragione, ci sforziamo molto nel campo della logistica. Un buon sistema di produzione migliora i tempi di preparazione ed invio, per questo abbiamo completa fiducia nelle migliori ditte di corrieri espressi. Ciò garantisce che i nostri prodotti arrivino nelle migliori condizioni e rispettando i tempi stimati.

Uma estreita relação com o cliente é um dos pilares da nossa empresa. Manter uma boa relação com eles e satisfazer as suas necessidades é algo em que damos grande ênfase, razão pela qual investimos muito esforço na logística. Um bom sistema de produção melhora os tempos de preparação e entrega, razão pela qual depositamos toda a nossa confiança nas melhores empresas de correio expresso. Isto assegura que os nossos produtos chegam nas melhores condições e dentro do prazo.



Almacén de materia prima con capacidad de 7.000 palets. // Raw material warehouse with a capacity of 7,000 pallets.

SOSTENIBILIDAD

SUSTAINABILITY
DURABILITÉ
SOSTENIBILITÀ
SUSTENTABILIDADE

En ARCOS Hermanos, nos comprometemos con la sostenibilidad como un valor fundamental. Estamos trazando un camino hacia un packaging más ecoamigable, comenzando por reemplazar el plástico por opciones de cartón reciclable, lo que representa un avance significativo en nuestra estrategia de reducción de residuos y promoción del reciclaje.

Nuestros programas educativos sobre el cuidado y mantenimiento de cuchillos buscan prolongar la vida útil de estos productos, disminuyendo la necesidad de reemplazos frecuentes. Además, en la fabricación, empleamos madera certificada FSC y reciclamos eficientemente los materiales sobrantes. Optimizamos el uso de recursos hídricos y energéticos, incluyendo energía 100% renovable.

Nuestro enfoque hacia la reducción de la huella de carbono también se refleja en iniciativas de compensación ambiental, como la plantación de árboles en proyectos de reforestación, contribuyendo a mitigar el impacto del cambio climático.

El bienestar de nuestros empleados es una prioridad, promovido a través del Arcos Sport Club y programas de salud. Nuestro Plan de Igualdad y estrategias de diversidad e inclusión aseguran un ambiente laboral equitativo. Colaboramos con centros ocupacionales para fomentar la inclusión laboral de personas con discapacidades, reafirmando nuestro compromiso con una sociedad más inclusiva y sostenible.

En ARCOS, nos alineamos con los Objetivos de Desarrollo Sostenible específicos, integrándolos en nuestro plan estratégico para avanzar hacia un futuro más sostenible y equitativo.

At ARCOS Hermanos, we are committed to sustainability as a core value. We are charting a path towards more eco-friendly packaging, starting by replacing plastic with recyclable cardboard options, which represents a significant advance in our waste reduction strategy and recycling promotion.

Our educational programs on knife care and maintenance aim to extend the life of these products, decreasing the need for frequent replacements. Moreover, in manufacturing, we use FSC certified wood and efficiently recycle leftover materials. We optimize the use of water and energy resources, including 100% renewable energy.

Our approach to carbon footprint reduction is also reflected in environmental compensation initiatives, such as tree planting in reforestation projects, helping to mitigate the impact of climate change.

The well-being of our employees is a priority, promoted through the Arcos Sport Club and health programs. Our Equality Plan and diversity and inclusion strategies ensure an equitable work environment. We collaborate with occupational centers to foster the labor inclusion of people with disabilities, reaffirming our commitment to a more inclusive and sustainable society.

At ARCOS, we align ourselves with specific Sustainable Development Goals, integrating them into our strategic plan to advance towards a more sustainable and equitable future.



Chez ARCOS Hermanos, nous nous engageons pour la durabilité comme valeur fondamentale. Nous traçons la voie vers un emballage plus écologique, en commençant par remplacer le plastique par des options en carton recyclable, ce qui représente une avancée significative dans notre stratégie de réduction des déchets et de promotion du recyclage.

Nos programmes éducatifs sur l'entretien et la maintenance des couteaux visent à prolonger la durée de vie de ces produits, en diminuant la nécessité de remplacements fréquents. De plus, dans la fabrication, nous utilisons du bois certifié FSC et recyclons efficacement les matériaux restants. Nous optimisons l'utilisation des ressources en eau et en énergie, y compris l'énergie 100% renouvelable.

Notre approche de la réduction de l'empreinte carbone se reflète également dans les initiatives de compensation environnementale, telles que la plantation d'arbres dans des projets de reforestation, contribuant ainsi à atténuer l'impact du changement climatique.

Le bien-être de nos employés est une priorité, promu par le Arcos Sport Club et les programmes de santé. Notre Plan d'égalité et les stratégies de diversité et d'inclusion assurent un environnement de travail équitable. Nous collaborons avec des centres professionnels pour favoriser l'inclusion au travail des personnes handicapées, réaffirmant notre engagement envers une société plus inclusive et durable.

Chez ARCOS, nous nous alignons sur des Objectifs de Développement Durable spécifiques, les intégrant dans notre plan stratégique pour avancer vers un avenir plus durable et équitable.



Na ARCOS Hermanos, estamos comprometidos com a sustentabilidade como um valor central. Estamos traçando um caminho para embalagens mais ecológicas, começando por substituir o plástico por opções de cartão reciclável, o que representa um avanço significativo em nossa estratégia de redução de resíduos e promoção da reciclagem.

Nossos programas educacionais sobre cuidados e manutenção de facas visam prolongar a vida útil desses produtos, diminuindo a necessidade de substituições frequentes. Além disso, na fabricação, usamos madeira certificada FSC e reciclamos materiais excedentes de forma eficiente. Otimizamos o uso de recursos hídricos e energéticos, incluindo energia 100% renovável.

Nossa abordagem para redução da pegada de carbono também é refletida em iniciativas de compensação ambiental, como o plantio de árvores em projetos de reflorestamento, ajudando a mitigar o impacto das mudanças climáticas.

O bem-estar de nossos funcionários é uma prioridade, promovido através do Arcos Sport Club e programas de saúde. Nosso Plano de Igualdade e estratégias de diversidade e inclusão garantem um ambiente de trabalho equitativo. Colaboramos com centros ocupacionais para promover a inclusão laboral de pessoas com deficiência, reafirmando nosso compromisso com uma sociedade mais inclusiva e sustentável.

Na ARCOS, alinhamos nossas ações com objetivos específicos de Desenvolvimento Sustentável, integrando-os em nosso plano estratégico para avançar em direção a um futuro mais sustentável e justo.

In ARCOS Hermanos, ci impegniamo per la sostenibilità come valore fondamentale. Stiamo tracciando un percorso verso un'imballaggio più ecologico, iniziando con la sostituzione della plastica con opzioni di cartone riciclabile, rappresentando un significativo progresso nella nostra strategia di riduzione dei rifiuti e promozione del riciclo.

I nostri programmi educativi sulla cura e manutenzione dei coltelli mirano a estendere la vita di questi prodotti, diminuendo la necessità di sostituzioni frequenti. Inoltre, nella produzione, utilizziamo legno certificato FSC e ricicliamo efficacemente i materiali residui. Ottimizziamo l'uso delle risorse idriche ed energetiche, inclusa l'energia rinnovabile al 100%.

Il nostro approccio alla riduzione dell'impronta di carbonio si riflette anche in iniziative di compensazione ambientale, come la piantumazione di alberi in progetti di riforestazione, contribuendo a mitigare l'impatto del cambiamento climatico.

Il benessere dei nostri dipendenti è una priorità, promosso attraverso l'Arcos Sport Club e programmi di salute. Il nostro Piano di Parità e le strategie di diversità e inclusione assicurano un ambiente di lavoro equo. Collaboriamo con centri occupazionali per favorire

l'inclusione lavorativa delle persone con disabilità, riaffermando il nostro impegno per una società più inclusiva e sostenibile.

In ARCOS, ci allineiamo con obiettivi specifici di Sviluppo Sostenibile, integrandoli nel nostro piano strategico per avanzare verso un futuro più sostenibile ed equo.



ARCOS EN EL MUNDO

ARCOS WORLDWIDE
ARCOS DANS LE MONDE
ARCOS NEL MONDO
ARCOS PELO MUNDO

ARCOS Hermanos tiene una superficie de trabajo dividida en diferentes plantas dentro de la provincia de Albacete (España). Podríamos decir que nuestra empresa no tiene fronteras, ya que podemos encontrar nuestros productos en cualquiera de los continentes. Operando en 94 países, ARCOS Hermanos distribuye sus piezas por todo el mundo, lo que nos convierte en la empresa líder de cuchillería, tanto profesional como de uso doméstico, cuyo nombre es conocido en todas partes. Queremos dejar nuestra huella y el éxito y calidad de nuestros productos nos hace viajar sin límites. En la actualidad, cuenta con un equipo humano de cerca de 500 personas, que fabrican 1.100 modelos diferentes de cuchillos y una media de 75.000 piezas diarias. En una superficie de más de 30.000 m², dividida en distintas plantas en la provincia de Albacete (España), se levanta esta industria.

Trabaja con la última tecnología de fabricación y la actualización constantemente, para que el nivel de calidad de cada producto sea siempre óptimo. Así pues, se consolida como empresa líder de cuchillería, tanto profesional como de uso doméstico.

ARCOS Hermanos has a work surface area divided into different plants within the province of Albacete (Spain). It can be said that our company has no borders, given that one can find our products in every continent. Operating in 94 countries, ARCOS Hermanos distributes its pieces worldwide, making us the leading cutlery-knife making company, both professional as well as national level, whose name is known everywhere. We want to leave our mark and the success and quality of our products confers on us the freedom of limitless movement. Our team of almost five hundred employees produces 1.100 different models of knives with a production average of 75,000 units per day. Our production process is divided between several factories located in the province of Albacete (Spain) with a total factory production area of over 30,000 square meters.

Because we work with the latest technologies and are constantly updating them to ensure the highest quality of our products, Arcos Hermanos, S.A. has become a Global leader in the development of professional and well as home cutlery.

ARCOS Hermanos a un espace de travail composé de plusieurs usines réparties dans la province d'Albacete (Espagne). Nous sommes en mesure d'affirmer que notre société n'a pas de frontières car nos produits se trouvent dans tous les continents. Présente dans 94 pays, ARCOS Hermanos distribue ses produits dans le monde entier, ce qui fait de nous la société leader dans le secteur coutellerie, tant professionnelle que domestique, sous un nom mondialement connu. Nous souhaitons laisser notre empreinte, et le succès et la qualité de nos produits nous font voyager sans aucune limite. Nous comptons actuellement sur une équipe de plus de 500 personnes qui fabriquent 1.100 modèles différents de couteaux dans une moyenne de 75.000 pièces par jour. C'est sur une superficie de plus de 30 000 m², divisée en plusieurs lieux et située dans la province d'Albacete en Espagne



que se développe cette industrie.

Nous travaillons avec la dernière technologie de fabrication actualisée constamment, an que le niveau de qualité de chaque produit soit toujours pour optimum. Ce qui nous assure la consolidation de notre entreprise comme leader, tant pour le monde professionnel que domestique

ARCOS Hermanos possiede una superficie di lavoro distribuita in varie installazioni nella provincia di Albacete (Spagna). Possiamo dire che la nostra impresa non ha frontiere, giacché possiamo trovare i nostri prodotti in tutti i continenti. ARCOS Hermanos è presente in 94 Paesi e distribuisce i suoi prodotti in tutto il mondo e ciò ci rende la ditta leader di coltelleria, sia di uso professionale come domestico, il cui nome è noto dappertutto. Vogliamo lasciare il nostro segno, e il successo e la qualità dei nostri prodotti ci fa viaggiare oltre tutti i confini. Fabbricanti di coltelleria da piu' di 270 anni, attualmente la nostra Azienda puo' contare su un capitale umano di 500 persone., che attendono alla produzione di 1.100 modelli diversi di coltelli, ad una media di 75.000 pezzi al giorno. La super cie totale coperta delle varie divisioni produttive, in provincia di Albacete , si aggira sui 30.000mq coperti. Lavoriamo avvalendoci delle ultimissime tecnologie di fabbricazione, aggiornate costantemente, per ottenere una uniformità assoluta di qualità per ciascun prodotto. Siamo inoltre consolidati e riconosciuti come la Impresa Leader sia nella produzione di coltelleria per uso professionale che casalingo.

ARCOS Hermanos tem uma superfície de trabalho dividida em diferentes plantas na provincia de Albacete (Espanha). Poderíamos dizer que a nossa empresa não tem fronteiras, uma vez que podemos encontrar os nossos produtos em qualquer dos continentes. Operando em 94 países, a ARCOS Hermanos distribui as suas peças por todo o mundo, o que nos torna a principal empresa de cutelaria, tanto profissional como doméstica, cujo nome é conhecido em todo o mundo. Queremos deixar a nossa marca e o sucesso e qualidade dos nossos produtos fazem-nos viajar sem limites. Atualmente, conta com uma equipa de cerca de 500 pessoas, que fabricam 1.100 modelos diferentes de facas e uma média de 75.000 peças por dia. Esta indústria está localizada numa área de mais de 30.000 m2, dividida em diferentes fábricas na provincia de Albacete (Espanha). Trabalha com a mais recente tecnologia de fabrico e atualiza-a constantemente, para que o nível de qualidade de cada produto seja sempre ótimo. Assim, consolidou a sua posição como empresa líder em cutelaria, tanto profissional como para uso doméstico.

BASQUE CULINARY CENTER

Es la primera facultad en gastronomía de España y referencia a nivel mundial. Desde su fundación en 2011 imparte el Grado en Gastronomía y Artes Culinarias y desde entonces ha desarrollado numerosos programas formativos de especialización, atrayendo a jóvenes estudiantes de todo el mundo.

Arcos se suma ahora como empresa colaboradora a este proyecto internacional, que cuenta con el apoyo de algunos de los chefs más influyentes del mundo.

The Basque Culinary Center is the first faculty of Gastronomic Sciences in Spain and is a worldwide reference benchmark. Since its founding in 2011, a Bachelor's Degree in Gastronomy and Culinary Art has been offered and subsequently numerous specialisation training programmes have been developed, attracting young students from all over the world. Arcos now joins as a collaborating company in this international project, which has the backing and support of some of the most influential chefs in the world.

Basque Culinary Center est la première faculté de gastronomie en Espagne et une référence dans le monde. Depuis sa fondation en 2011, elle dispense des études donnant droit au Diplôme en Gastronomie et Arts Culinaires et depuis lors, elle a développé de nombreux programmes de formation de spécialisation, attirant des jeunes étudiants venus des quatre coins du monde. Arcos est désormais une entreprise partenaire de ce projet international, bénéficiant du soutien de certains des chefs les plus influents du monde.

Il Basque Culinary Center è la prima facoltà di gastronomia della Spagna e un riferimento a livello mondiale. Da quando è



stato fondato, nel 2011, impartisce i corsi della Laurea breve in Gastronomia ed Arti Culinarie ed ha sviluppato numerosi programmi formativi di specializzazione, attirando giovani studenti provenienti da tutto il mondo. Ora Arcos si somma a questo progetto internazionale come impresa collaboratrice che possiede il supporto di alcuni fra i più influenti chef del mondo.

O Basque Culinary Center é a primeira faculdade de gastronomia em Espanha e uma referência mundial. Desde a sua fundação em 2011, ensina a Licenciatura em Gastronomia e Artes Culinárias e desde então tem desenvolvido numerosos programas de formação de especialização, atraindo jovens estudantes de todo o mundo. A Arcos junta-se agora a este projeto internacional como uma empresa colaboradora, que tem o apoio de alguns dos chefs mais influentes do mundo.

Después de casi 10 años de colaboración continuamos formando parte de la gran familia Euro-Toques España. Organización de cocineros formada por 800 socios y presidida por Andoni Luis Aduriz, uno de los chefs más influyentes de nuestro tiempo, con dos estrellas Michelin en su restaurante Mugaritz.

After almost 10 years of collaboration, we continue being part of the great Euro-Toques España family. An organisation of chefs made up of 800 members and chaired by Andoni Luis Aduriz, one of the most influential chefs of our time, with his two Michelin star restaurant Mugaritz.

Après près de 10 ans de collaboration, nous faisons toujours partie de la grande famille Euro-Toques Espagne. Organisation de cuisiniers constituée de 800 associés et présidée par Andoni Luis Aduriz, l'un des chefs les plus influents de notre ère, doublement étoilé Michelin dans son restaurant Mugaritz.

Dopo quasi 10 anni di collaborazione, continuiamo a far parte della grande famiglia di Euro-Toques España, un'organizzazione di cuochi che conta 800 soci ed è presieduta da Andoni Luis Aduriz, uno degli chef più influenti dei nostri tempi e il cui ristorante Mugaritz possiede due stelle Michelin.

Após quase 10 anos de colaboração, continuamos a fazer parte da grande família Euro-Toques España. Uma organização de chefs composta por 800 membros e presidida por Andoni Luis Aduriz, um dos chefs mais influentes do nosso tempo, com duas estrelas Michelin no seu restaurante Mugaritz.

EURO- TOQUES



TOLEDO 2022



Karlos Arguiñano en su programa de TV "Cocina Abierta" // Karlos Arguiñano on his TV show "Cocina Abierta"

Arcos ha estado presente en las pantallas de todo el mundo, compartiendo momentos inolvidables en numerosas producciones. No solo en los programas de cocina tan reconocidos como Master Chef, si no también participando en películas de cineastas tan internacionales como Pedro Almodóvar. Pero el cocinero que más tiempo ha confiado en Arcos, trabajando con nuestros cuchillos y ahora con nuestro menaje en su programa durante más de 30 años, es el inigualable Karlos Arguiñano.

Arcos has appeared on screens all over the world, sharing unforgettable moments in numerous productions. Not only in the famous cooking shows such as Master Chef, but also by taking part in the international films of filmmakers like Pedro Almodóvar. However the chef who has trusted in Arcos the longest, working with our knives and now using our tableware in his show for more than 30 years, is the unbeatable Karlos Arguiñano.

Arcos a fait sa marque sur les écrans du monde entier, partageant des moments inoubliables dans de nombreuses productions. Non seulement dans des émissions de cuisine aussi reconnues que Master Chef, mais aussi en participant à des films de réalisateurs aussi internationaux que Pedro Almodóvar. Cependant, le chef qui a le plus longtemps fait confiance à Arcos, travaillant avec nos couteaux et maintenant avec notre équipement dans son émission depuis plus de 30 ans, est le légendaire Karlos Arguiñano.

Arcos è apparsa sugli schermi di tutto il mondo, condividendo momenti indimenticabili in svariate produzioni. Non solo in rinomati programmi di cucina, come Master Chef, ma ha partecipato anche a film di cineasti internazionali, come Pedro Almodóvar. Ma il cuoco che più a lungo si è affidato a Arcos, lavorando nel suo programma con i nostri coltelli per più di 30 anni e ora con il nostro servizio, è l'impareggiabile Karlos Arguiñano.

A Arcos tem estado presente nos ecrãs de todo o mundo, partilhando momentos inesquecíveis em inúmeras produções. Não só em programas de cozinha de renome como Master Chef, mas também participando em filmes de cineastas internacionais como Pedro Almodóvar. Mas o chef há mais tempo a confiar na Arcos, trabalhando com as nossas facas e agora com os nossos utensílios de cozinha no seu programa há mais de 30 anos, é o incomparável Karlos Arguiñano.

EN ESCENA

ON STAGE
SUR SCÈNE
IN SCENA
EM CENA



INFORMACIÓN

INFORMATION
INFORMATION
INFORMAZIONI



1. PUNTA / TIP / POINTE / PUNTA

Extremo puntiagudo del cuchillo / Pointed end of the knife / Extrême pointe du couteau / Punto estremo finale del coltello

2. HOJA / BLADE / LAME / LAMA

Lámina generalmente de acero, que constituye la parte cortante de un cuchillo / Usually made from a sheet of steel / Lame généralement en acier qui constitue la partie coupante d'un couteau / Lamina generalmente in acciaio, che costituisce la parte tagliente del coltello

3. FILO / CUTTING EDGE / FIL / FILO

Borde afilado de la hoja del cuchillo. Este filo puede ser: Filo Simple - Filo Doble - Filo Sierra - Filo Alveolos / Sharp edge of the blade of the knife. The edge can be: Single Edge - Double Edge - Serrated edge - Hollow edge / Bord affile de la lame. Le fil pourra être: simple fil- double fil- fil cranté - fil alvéolé / Parte o bordo affilato della lama del coltello, che può essere: Filo semplice - doppio filo - seghettatura- filo ad alveoli /

4. RECAZO / BACK / DOS / DORSO

Parte opuesta al filo del cuchillo / The back of the knife / Partie opposée au fil / Parte opposta al filo della lama del coltello

5. DEFENSA / DEFENSE / LA GARDE / DIFESA

Tope que ofrece mayor seguridad durante el corte / Near the bottom of the bolster. Shields the hand during the cutting process / Le butoir offre une plus grande sécurité durant la coupe / Bordo accanto alla lama che offre maggior sicurezza durante il taglio

6. VIROLA / BOLSTER / VIROLE / BILANCIATURA

Parte de unión entre la hoja y el mango, con la que se equilibra el cuchillo / The end of the blade that extends into the handle. Balances the knife / Partie de liaison entre la lame et le manche / Parte di unione fra la lama e il manico che serve per equilibrare il coltello

7. CACHAS / SCALES / COTES / GUANCETTE

Se denominan así las dos partes que forman el mango / Attached to the tang to form the handle / Ce sont les 2 parties qui sont de part et d'autre du manche / Sono così denominate le due parti che unite formano il manico.

8. REMACHES / RIVETS / RIVETS / RIVETTI

Unen el mango a la espiga completamente / Connects the handle to the tang / Unissent les cotes et la soie complètement / Uniscono completamente il manico alla spiga del coltello .

CONSEJOS

TIPS

CONSEILS

CONSIGLI

CONSELHOS

CONSEJOS DE UTILIZACIÓN Y MANTENIMIENTO

- 01| Lave los cuchillos inmediatamente después de su uso. Evite el contacto prolongado con restos de alimentos.
- 02| Empleé un detergente neutro o poco alcalino
- 03| No use lejía, sosa o detergentes que contengan cloro o cloruros libres pues corroen el acero o comen el brillo original.
- 04| Evite frotar los cuchillos con productos o estropajos abrasivos así como limpiadores metálicos o sintéticos.
- 05| En el lavavajillas coloque los cuchillos con las hojas hacia abajo, en cestos separados del resto de la vajilla y la cubertería, así evitará cualquier roce.
- 06| No deje los cuchillos sumergidos de forma prolongada en agua, sobre todo si se trata de aguas duras o salinas que afectan al metal.
- 07| Seque inmediatamente los cubiertos con paños suaves y absorbentes.
- 08| El secado del lavavajillas, normalmente no es suficiente para evitar la corrosión.
- 09| Termine de secar las piezas después del ciclo de secado con un paño.
- 10| Procure no dejar mucho tiempo la cubertería en el interior del lavaplatos.

TIPS FOR USE AND MAINTENANCE

- 01| Wash knives immediately after use. Avoid prolonged contact with leftover food.
- 02| Use a neutral or slightly alkaline detergent
- 03| Do not use bleach, soda or detergents containing chlorine or chlorides ions because they rust the steel and cause it to lose its shine.
- 04| Avoid rubbing your knives with abrasive products, cloths, and metallic or synthetic cleaners.
- 05| If you use a dishwasher, place your knives in with the blades facing down and in separate containers from the rest of your cutlery to avoid scratching.
- 06| Avoid leaving your knives submerged in water for long periods of time, especially in hard or saline water which can affect metals.
- 07| Dry immediately with soft, absorbent cloth.
- 08| Leaving your knives to dry in the dishwasher is not recommended.
- 09| Dry your cutlery immediately with a soft and absorbent cloth
- 10| Do not to leave your cutlery in the dishwasher for long periods of time.

CONSEILS D'UTILISATION

- 01| Laver les couteaux immédiatement après leur utilisation afin d'éviter un contact prolongé avec des aliments.
- 02| Utiliser un détergeant neutre et peu alcalin.
- 03| Ne pas utiliser de l'eau de javel, de la soude ou des détergents qui contiennent du chlore qui peuvent attaquer l'acier et enlever le brillant original.
- 04| Eviter de frotter les lames avec des pailles de fer.
- 05| Dans le lave vaisselle, disposer les lames de couteaux vers les bas dans le panier et en les séparant des autres couverts afin de ne pas se blesser.
- 06| Ne pas laisser les couteaux tremper longuement dans de l'eau, surtout si ce sont des eaux dures ou salines.
- 07| Sécher immédiatement les couteaux avec des torchons doux et absorbants.
- 08| Le séchage en lave vaisselle, normalement n'est pas suffisant pour éviter la corrosion.
- 09| Finir de sécher les pièces après un cycle de séchage avec un torchon.
- 10| Ne pas laisser les couteaux longtemps à l'intérieur du lave vaisselle.

CONSIGLI PER IL MIGLIOR UTILIZZO E MANTENIMENTO DEL COLTELLO

- 01| Lavate i coltelli immediatamente dopo l'utilizzo e non lasciateli a lungo a contatto con gli alimenti.
- 02| Utilizzate un detersivo non molto aggressivo.
- 03| Non usare detersivi che contengano cloro o cloruri che possono determinare la corrosione e la perdita della lucentezza del coltello.
- 04| Evitate di sfregare i coltelli con altri oggetti inox, come pulitori metallici etc.
- 05| Collocare i coltelli nella lavastoviglie con la punta della lama rivolta verso il basso, ed in un cesto separati dalle altre stoviglie.
- 06| Non lasciare i coltelli a lungo bagnati, soprattutto se si tratta di acqua salina.
- 07| Asciugare il piu' presto possibile i coltelli con un panno.
- 08| L'asciugatura della lavastoviglie normalmente non è sufficiente.
- 09| Ripassate in seguito il coltello con un panno asciutto.
- 10| Abbiate cura di non lasciare i coltelli a lungo nella lavastoviglie.



ARCOS[®]
Albacete (Spain) Since 1734

La empresa se reserva el derecho a cualquier modificación / The company reserves the right to any modification
L'entreprise se réserve le droit à toutes modifications / La ditta si riserva di apportare qualsiasi modifica al presente catalogo che venga ritenuta necessaria
A empresa reserva-se o direito a qualquer modificação.